

Countermeasures

Study group organized by the
Union of Concerned Scientists and the
Security Studies Program at the
Massachusetts Institute of Technology

Countermeasures

A Technical Evaluation of the
Operational Effectiveness of the Planned
US National Missile Defense System

Andrew M. Sessler (Chair of the Study Group), John M. Cornwall,
Bob Dietz, Steve Fetter, Sherman Frankel, Richard L. Garwin, Kurt Gottfried,
Lisbeth Gronlund, George N. Lewis, Theodore A. Postol, David C. Wright

April 2000

Union of Concerned Scientists
MIT Security Studies Program

© 2000 Union of Concerned Scientists

All rights reserved

The Union of Concerned Scientists is a partnership of citizens and scientists working to build a cleaner environment and a safer world. For more information about UCS's work on arms control and international security, visit the UCS website at www.ucsusa.org.

The Security Studies Program (SSP) is a graduate-level research and educational program based at the Massachusetts Institute of Technology's Center for International Studies. The program's primary task is educating the next generation of scholars and practitioners in international security policymaking. SSP supports the research work of graduate students, faculty, and fellows, and sponsors seminars, conferences, and publications to bring its teaching and research results to the attention of wider audiences.

Cover illustration: An artist's rendition of two kill vehicles approaching a cluster of balloon decoys, one of which might enclose a warhead.

This report is available online at www.ucsusa.org. To order printed copies:

- Email pubs@ucsusa.org
- Call 617-547-5552
- Write to
Publications Department
Union of Concerned Scientists
P.O. Box 9105
Cambridge, MA 02238-9105

Printed on recycled paper.

Acknowledgments

The authors would like to thank Tom Collina, Stuart Kiang, Matthew Meselson, and Jeremy Broughton for their comments and assistance. The authors owe a special note of gratitude to Eryn MacDonald and Anita Spiess for their contributions and dedication, without which this report would not have been possible.

This report and its dissemination were funded in part by grants to the Union of Concerned Scientists from the Carnegie Corporation of New York, The John D. and Catherine T. MacArthur Foundation, The John Merck Fund, The New-Land Foundation, Inc., Ploughshares Fund, and the W. Alton Jones Foundation; and to the MIT Security Studies Program from the W. Alton Jones Foundation, The John D. and Catherine T. MacArthur Foundation, the Ford Foundation, and the Carnegie Corporation of New York.

To Henry Kendall, who was part of the study group, and whose intellectual contributions and personal involvement we greatly missed in preparing this report.

Contents in Brief

Contents in Detail	ix
Figures	xiv
Tables	xvi
Boxes	xvii
Executive Summary	xix
1. Introduction	1
2. The Existing and Emerging Ballistic Missile Threat to the United States	5
3. The Planned NMD System	19
4. Countermeasures to the Planned NMD System: Why the Attacker Has the Advantage	31
5. Countermeasure Programs in the United States, Britain, France, Russia, and China	35
6. An Overview of Emerging Missile State Countermeasures	39
7. Emerging Missile State Countermeasures 1: Submunitions with Biological or Chemical Agents	49
8. Emerging Missile State Countermeasures 2: Anti-Simulation Balloon Decoys for Nuclear Warheads	59
9. Emerging Missile State Countermeasures 3: A Nuclear Warhead with a Cooled Shroud	81
10. Testing the NMD System: Requirements and Recommendations	91
11. Past US Tests Against “Countermeasures”	103
12. The Security Costs of NMD Deployment	107
13. Deterrence and Diplomacy	115
Appendices	
A. The Thermal Behavior of Objects in Space	119
B. The Measurement and Discrimination Capabilities of SBIRS-Low	125
C. The Radar Cross Section of Warheads and Other Objects	131
D. The Measurement and Discrimination Capabilities of the NMD Ground-Based Radars	135
E. Countermeasures to Ballistic Missile Defenses: Past and Current Programs in the United States, France, and Britain	145
F. The Reentry Heating of Submunitions	149
G. NASA Air Density Explorer Series Inflatable Balloon Satellites	159
H. The Thermal Effects of a Warhead Inside a Balloon	161
I. Shroud Cooling Requirements	167
J. Exoatmospheric Hit-to-Kill Intercept Tests	169
Contributor Biographies	173

Contents in Detail

Figures	xiv
Tables	xvi
Boxes	xvii
Executive Summary	xix
1. Introduction	1
Purpose of the Study	1
Scope of the Study	2
Criteria for Deployment	3
Sources and Methods	4
The Structure of This Report	4
2. The Existing and Emerging Ballistic Missile Threat to the United States	5
An Accidental, Unauthorized, or Erroneous Launch by Russia	5
Size of the Future Russian Nuclear Arsenal	8
An Accidental, Unauthorized, Erroneous, or Deliberate Attack by China	9
The Threat from Emerging Missile Powers	10
Warheads Available to Emerging Missile Powers	12
<i>Conventional Warheads</i>	13
<i>Chemical Warheads</i>	13
<i>Biological Warheads</i>	15
<i>Nuclear Warheads</i>	16
3. The Planned NMD System	19
How the NMD System Would Evolve over Time	19
How the NMD System Is Designed to Operate	20
Launch Detection	21
Warhead Detection and Tracking	26
Warhead Discrimination	27
Interceptor Guidance	28
Kill Vehicle Homing	28
Battle Management	28
4. Countermeasures to the Planned NMD System: Why the Attacker Has the Advantage	31
Defense Will Commit First	31
Defense Must Work First Time	32
Defense More Technically Demanding than Offense	32
Standards of Success for Defense Are High	32

5. Countermeasure Programs in the United States, Britain, France, Russia, and China	35
Past and Current Countermeasure Programs to Ballistic Missile Defenses	35
United States	35
<i>Countermeasures for ICBMs</i>	35
<i>Countermeasures for SLBMs</i>	36
France	36
Britain	36
Russia	36
China	37
6. An Overview of Emerging Missile State Countermeasures	39
Overwhelming the Defense: Submunitions for Biological and Chemical Weapons	41
Decoys: Overwhelming the Defense with False Targets	41
Replica Decoys	42
Decoys Using Signature Diversity	43
Decoys Using Anti-simulation	43
<i>Metallized Balloons</i>	44
<i>Shrouds of Multilayer Insulation</i>	44
<i>Chaff</i>	44
<i>Electronic Decoys</i>	45
Late Deployment of Decoys	46
Reducing Radar Signatures	46
Prevent Hit-to-Kill by Infrared Stealth	47
Low-Emissivity Coatings	47
Cooled Shroud	47
Prevent Hit-to-Kill Homing by Hiding the Warhead	48
Warhead Maneuvers	48
Preemptive Attacks on Defense Components	48
7. Emerging Missile State Countermeasure 1: Submunitions with Biological or Chemical Agents	49
Should the Baseline Threat Include Chemical and Biological Weapons?	49
Submunitions	49
The Design, Construction, and Use of Submunitions	53
<i>Details of Dispensing Bomblets</i>	54
<i>Details of Heat Shielding of Bomblets During Reentry</i>	55
<i>Heating or Cooling of Bomblets During Midcourse</i>	57
<i>Releasing the Agent</i>	57
8. Emerging Missile State Countermeasure 2: Anti-Simulation Balloon Decoys for Nuclear Warheads	59
Design, Construction, and Deployment of Balloons	61
How Anti-Simulation Balloon Decoys Would Prevent Midcourse Discrimination	63
Discrimination by Infrared Sensors	64
<i>Daytime Attacks</i>	64
The thermal behavior of empty balloons	64
The thermal behavior of a balloon containing a warhead	65
Nonuniform balloon temperatures	67

<i>Nighttime Attacks</i>	67
<i>Decoys Effective for Both Daytime and Nighttime Attacks</i>	69
Discrimination by Radars: Mechanical Interactions Between Warhead and Balloon	69
Discrimination and Intercept During Early Reentry	70
Measures the Attacker Could Take to Prevent Discrimination	73
<i>Denying High Precision Velocity and Position Measurements</i>	73
<i>Exploit the Defense Geometry</i>	75
<i>Cold-Gas Thrusters</i>	76
<i>Spinning or Oscillating Balloons</i>	76
<i>Tethered Clusters of Balloons</i>	77
Exploit Defense Limitations in Determining the Target Position	77
9. Emerging Missile State Countermeasure 3: A Nuclear Warhead with a Cooled Shroud	81
The Design Details	81
Reduced Infrared Detection Range	84
Detection Using Reflected Radiation	85
Reflected Infrared Radiation	86
Reflected Visible Light	87
10. Testing the NMD System: Requirements and Recommendations	91
Testing Military Systems	91
Confidence Levels and Effectiveness	92
The Operational Requirements for the Planned NMD System	94
Determining the Single-Shot Kill Probability	95
Independence of Failure Modes	95
Testing and Countermeasures	96
The Planned Testing Program for the NMD System	97
An NMD Testing Program to Assess Operational Effectiveness	100
1. Ask the right question: Accurately define the baseline threat	100
2. Make it possible to get a valid answer to the question: Provide for the best in countermeasure testing	100
3. Answer the question well: Conduct enough tests	101
4. Make sure the answer is correct: Provide for objective, independent test assessment	101
11. Past US Tests Against “Countermeasures”	103
The Use of “Decoys” in ERIS Tests	103
MSX Experiment	103
Sensor Fly-by Tests for NMD	104
Tests of Ground-based Radar at Kwajalein	105
First NMD Intercept Test	105
Second NMD Intercept Test	106
An ERINT Test Against “Submunitions”	106

12. The Security Costs of NMD Deployment	107
Russia	107
China	111
Emerging Missile States	112
Other States	113
Conclusions	113
13. Deterrence and Diplomacy	115
Emerging Missile States	115
Export Controls	115
Cooperation	116
Deterrence	116
Prelaunch Destruction	117
Boost-Phase Defenses	117
Russia and China	118
Russia	118
China	118
Appendices	
A. The Thermal Behavior of Objects in Space	119
The Physics of a Blackbody	119
The Physics of a Graybody	120
The Physics of Real Targets	120
Equilibrium Temperatures in Space	121
<i>Objects in daylight</i>	121
<i>Objects at night</i>	123
Time Required to Reach Equilibrium Temperature	123
B. The Measurement and Discrimination Capabilities of SBIRS-Low	125
Medium- to Long-Wave Infrared and Long-Wave Infrared Sensors	126
Sensor Resolution	126
Detection Range	127
Visible Light Sensor	128
Sensor Resolution	128
Detection Range	128
SBIRS-Low Measurements of Targets in Space	128
Detection of Targets	128
Temperature Measurements	128
Measurements of Emissivity-Area Product	128
Other Measurements	129
C. The Radar Cross Section of Warheads and Other Objects	131
High-Frequency Regime	131
Resonance Regime	132
Low-Frequency Regime	134

D. The Measurement and Discrimination Capabilities of the NMD Ground-Based Radars	135
General Discussion	135
Detection Range	135
Radar Cross-Section Measurements	136
Measurement of Angular Location and Resolution	136
Range Measurement and Resolution	138
Radial Velocity (Doppler) Measurement and Resolution	138
Imaging Using Doppler Measurements	139
The Measurement and Discrimination Capabilities of the NMD Radars	139
PAVE PAWS Radars	141
BMEWS (Ballistic Missile Early Warning System) Radars	142
Upgraded Early Warning Radars	142
X-Band Radars	142
E. Countermeasures to Ballistic Missile Defenses: Past and Current Programs in the United States, France, and Britain	145
United States	145
Countermeasures for ICBMs	145
Countermeasures for SLBMs	146
France	147
Britain	147
F. The Reentry Heating of Submunitions	149
Heatshield Calculations	150
Analysis for the Spherical Bomblet	151
Analysis for the Conical Bomblet	155
Cooling of the Spherical Bomblet During Midcourse	157
G. NASA Air Density Explorer Series Inflatable Balloon Satellites	159
H. The Thermal Effects of a Warhead Inside a Balloon	161
Radiation	161
Conduction Through Spacers	162
Conduction Through the Gas Used to Inflate the Balloon	162
Convection of the Gas	163
Effect of Warhead on Balloon Temperature	163
Heating Due to the Fissile Material in the Warhead	164
I. Shroud Cooling Requirements	167
J. Exoatmospheric Hit-to-Kill Intercept Tests	169
Contributor Biographies	173

Figures

3-1	View from space of C-1 National Missile Defense system	22
3-2	View from space of C-2 National Missile Defense system	23
3-3	View from space of C-3 National Missile Defense system	24
6-1	Photograph of a US replica decoy for the MARK IV reentry vehicle	43
6-2	A schematic drawing of a US Navy electronic reentry decoy	46
7-1	The configuration used for calculating the heating of a conical bomblet	54
7-2	The trajectory a bomblet would have with no δv after burnout of the missile	54
8-1	A photograph of one of the NASA Air Density Explorer inflatable balloon satellites	61
8-2	Temperature as a function of time after deployment of lightweight aluminum balloons coated with varying amounts of white paint	66
8-3	Velocity change due to drag	71
8-4	Position change due to drag	71
8-5	Radar map confusion for three balloons	78
9-1	Schematic diagram of liquid nitrogen cooled shroud	82
9-2	Spinning motion of warhead and shroud will confine liquid-phase nitrogen to outer and lower regions of the shroud	83
9-3	Prior to reentry, the shroud could be separated from the warhead using a spring-loaded device	83
9-4	Relative emission of a blackbody and relative detection range as a function of target temperature	84
9-5	Assumed intercept geometry	85
9-6	The region of no reflection for a tipped warhead	86
9-7	Trajectories from North Korea to New York, Chicago, San Francisco, and Hawaii during midwinter	88
9-8	Trajectories from North Korea to San Francisco and Hawaii during midspring and midfall	88
9-9	Trajectories from North Korea to Hawaii during midsummer.	89
9-10	Trajectory from Iran to Washington, D.C. during midfall or midspring	89
10-1	Probability distribution for 20 flips and 200 flips	94
11-1	The target suite for the first two NMD intercept tests	106

A-1	The spectral radiant exitance of two objects as a function of wavelength.	120
A-2	The temperature of four empty balloons with different surfaces (0.5 kg balloons)	123
A-3	The temperature of four empty balloons with different surfaces (3 kg balloons)	124
C-1	Experimental measurements of the radar cross-section of a cone-sphere as a function of aspect (viewing) angle θ	132
C-2	Radar cross-section of a sharply pointed cone-sphere as a function of radar frequency	133
C-3	RCS in resonance regime as a function of radar frequency	134
D-1	The radar energy reflected off two identical targets as a function of the angular position of the center of the radar beam	137
F-1	Speed as a function of altitude for the spherical bomblet	152
F-2	How the heating equations are applied to the sphere	152
F-3	The local heating rate for the spherical bomblet	152
F-4	Altitude as a function of time for the spherical bomblet	153
F-5	The average heating rate of the spherical bomblet as compared with the stagnation point heating rate of the conical bomblet and two reentry vehicles	153
F-6	The surface-averaged heating rate of the spherical bomblet compared with the heating rate on the wall of the conical bomblet and two reentry vehicles	153
F-7	Value of the effective heat of ablation used in the calculations for refrasil phenolic heatshield material	154
F-8	Temperature profile in the outer centimeter of heatshield for the spherical bomblet	154
F-9	Evolution of the temperature profile in the heatshield of the spherical bomblet at times later than F-8	155
F-10	Speed as a function of altitude for the conical bomblet	155
F-11	Altitude as a function of time for the conical bomblet	156
F-12	Local heating rates for the conical bomblet	156
F-13	Temperature profile in the heatshield at the nose of the conical bomblet	156
F-14	Temperature profile in the heatshield at a point on the wall of the conical bomblet	156
H-1	Temperature variation after deployment of aluminum-coated balloons with and without warheads	164
H-2	Temperature variation after deployment of painted balloons with and without warheads, near room temperature	165

Tables

2-1	Russian Ballistic Missile-Based Strategic Nuclear Forces, End of 1998	6
2-2	Chinese Missile-Based Intercontinental Nuclear Forces	9
3-1	Preliminary Architecture for the C-1, C-2, and C-3 NMD Systems	21
7-1	Stability of common CB agents to heat exposure	56
8-1	Equilibrium temperature, for various coatings, of a sphere in sunlight	64
8-2	The radar horizon for targets at different altitudes	74
9-1	Lateral kill vehicle acceleration required to hit the target	85
10-1	Schedule of the NMD Intercept Tests Currently Planned	99
A-1	The visible absorptivities, infrared emissivities, and their ratio, for several materials	122
B-1	Peak radiation emitted by objects at different temperatures	125
B-2	The six different MSX sensor bands	127
D-1	Characteristics and Measurement Capabilities of Current and Planned Radars	140

Boxes

Other Means of Delivery	12
Delivery of Chemical and Biological Weapons by Ballistic Missile	14
NMD Components	25
US Programs for Delivery of Chemical and Biological Weapons	52
The Velocity and Position Measurement Accuracy of an X-Band Radar	75
Effectiveness and Confidence Levels: An Illustration	94
Discrimination	104
Russian Statements on NMD	109
Chinese Statements on NMD	111
Allied Statements on NMD	114
Measurement Accuracy and Resolution	137

Executive Summary

The National Missile Defense system under development by the United States would be ineffective against even limited ballistic missile attacks from emerging missile states. Moreover, its deployment would increase nuclear dangers from Russia and China, and impede cooperation by these countries in international efforts to control the proliferation of long-range ballistic missiles and weapons of mass destruction.

The United States should reconsider its options for countering the threats posed by long-range ballistic missiles and shelve the current NMD plans as unworkable and counterproductive.

The United States plans to decide in fall 2000 whether to begin deploying a limited national missile defense (NMD) system. This system is intended to defend US territory from limited attacks by tens of intercontinental-range ballistic missiles armed with nuclear, chemical, or biological weapons. Such attacks could include a deliberate attack by an emerging missile state that might acquire such missiles in the future; an accidental, unauthorized, or erroneous attack by Russia; or an attack by China.

The NMD system would use ground-based interceptor missiles to launch “kill vehicles,” intended to destroy their targets by colliding with them in the midcourse of their trajectory, outside the earth’s atmosphere. The system would track warheads using ground-based radars and satellite-based infrared sensors, and the kill vehicles would use infrared sensors to home on their targets. The planned system would be deployed in phases, with the nominal capability of the system increasing in each phase. If the United States decides this year to begin deployment, the initial phase is to be completed by 2005 and the full system by as early as 2010.

This report examines in detail whether the planned NMD system would work against real world missile attacks. It focuses on the effectiveness of the system against the most commonly cited (and presumably the least sophisticated) threat: attacks by emerging missile states.

While the number of attacking missiles would have a significant impact on the operational effectiveness of the NMD system, of greater importance would be the “countermeasures” an attacker took to confuse, overwhelm, or otherwise defeat the defense. The 1999

National Intelligence Estimate on the ballistic missile threat to the United States—a document prepared by the US intelligence community—stated that countermeasures would be available to emerging missile states. Our study first considers the types of countermeasures that a real adversary could use to counter the NMD system, and that the system must therefore expect to face. We then make a detailed technical assessment of the operational effectiveness of the planned NMD system against a limited attack using three specific countermeasures that would be available to any state able to deploy a long-range ballistic missile.

Our analysis of the effectiveness of the NMD system assumes it has *all* of the sensors and interceptors planned for the *full* system to be deployed only by 2010 or later. However, countermeasures could be deployed more rapidly and would be available to potential attackers *before* the United States could deploy even the much less capable first phase of the system.

The contributors to the study are all physicists or engineers. Our analysis is based on an understanding of basic physics and technology and uses only information available in the open literature. This detailed analysis is possible because the United States is now so close to potential deployment that it has selected the specific interceptor and sensor technologies that the NMD system would use. We do not believe that access to classified information would in any significant way alter our study or its conclusions.

The United States must assume that any potential attacker would conduct a similar, although far more sophisticated, analysis.

Overall Findings and Recommendations:

(1) Any country capable of deploying a long-range missile would also be able to deploy countermeasures that would defeat the planned NMD system.

Biological or chemical weapons can be divided into many small warheads called “submunitions.” Such submunitions, released shortly after boost phase, would overwhelm the planned defense. Moreover, there are no significant technical barriers to their deployment or use. Because submunitions allow for more effective dispersal of biological and chemical agents, an attacker would have a strong incentive to use them even in the absence of missile defenses. The United States should recognize that any long-range missile attack with biological or chemical agents would almost certainly be delivered by submunitions, and that the NMD system could not defend against such an attack.

An attacker using nuclear weapons could also defeat the planned system. An attacker could overwhelm the system by using “anti-simulation balloon decoys,” that is, by deploying its nuclear weapons inside balloons and releasing numerous empty balloons along with them. Or an attacker could cover its nuclear warheads with cooled shrouds, which would prevent the kill vehicles from detecting and therefore from homing on the warhead.

Thus, we find that the planned NMD system would not be effective against the limited long-range missile threats it is intended to defend against—whether from Russia, China, or emerging missile states. We also conclude that deploying the planned NMD system would result in Russian and Chinese reactions that would decrease US security.

Deployment of the planned NMD system would offer the United States very little, if any, protection against limited ballistic missile attacks, while increasing the risks from other more likely and more dangerous threats to US national security.

(2) The upcoming deployment decision will be made on the wrong technical criteria.

The Pentagon will assess the technical readiness of the system prior to the presidential deployment decision. However, this assessment will consider only whether the first phase of the system would be effective against a threat with no credible countermeasures; it will not consider whether the full system would be effective against a threat with realistic countermeasures.

The United States cannot reasonably exclude the issue of countermeasures from a decision to deploy the first phase of the system. A sound understanding of this issue is needed before a deployment decision is made—even about the first phase. If—as this study finds—even the full NMD system would not be effective against an attacker using countermeasures, and an attacker could deploy such countermeasures before even the first phase of the NMD system was operational, it makes no sense to begin deployment.

(3) A deployment decision should be postponed until the system has been tested successfully against realistic countermeasures such as those described in this report.

Tests against realistic countermeasures will not be conducted before the United States makes its planned deployment decision. And it appears that such tests are not even planned to take place before deployment of the initial phase of the system.

The United States should recognize that the planned defense could not counter missiles armed with submunitions filled with biological or chemical weapons, and thus would provide no protection against the threat posed by long-range missiles armed with biological or chemical weapons. For the threat of missiles armed with nuclear warheads, the United States should demonstrate—first by analysis and then in intercept tests—that the planned defense would be effective against realistic countermeasures such as those we examine in this study: a nuclear warhead deployed with anti-simulation balloon decoys, and a nuclear warhead covered by a cooled shroud. This should be done before the United States makes a commitment to deploy even the first phase of the planned NMD system.

Detailed Findings

(1) The planned NMD system could be defeated by technically simple countermeasures. Such countermeasures would be available to any emerging missile state that deploys a long-range ballistic missile.

There are numerous tactics that an attacker could use to counter the planned NMD system. None of these countermeasures is new; indeed, most of these ideas are as old as ballistic missiles themselves.

All countries that have deployed long-range ballistic missiles (Britain, China, France, Russia, and the United States) have developed, produced, and in some cases deployed, countermeasures for their missiles. There is no reason to believe that emerging missile states would behave differently, especially when US missile defense development is front-page news.

Many highly effective countermeasures require a lower level of technology than that required to build a long-range ballistic missile (or nuclear weapon). The United States must anticipate that any potentially hostile country developing or acquiring ballistic missiles would have a parallel program to develop or acquire countermeasures to make those missiles effective in the face of US missile defenses. Countermeasure programs could be concealed from US intelligence much more easily than missile programs, and the United States should not assume that a lack of intelligence evidence is evidence that countermeasure programs do not exist.

Many countermeasures are based on basic physical principles and well-understood technologies. As a consequence, a vast amount of technical information relevant to building and deploying countermeasures is publicly available. Any country capable of building a long-range ballistic missile would have the scientific and technical expertise, including people who have worked on missiles for many years, to exploit the available technologies. Moreover, a great deal of technical information about the planned NMD system and its sensors has been published. A potential attacker could learn from a variety of open sources enough about the planned NMD system to design countermeasures to defeat it.

To determine whether technically simple countermeasures would be effective against the planned NMD system, we examined three potential countermeasures in detail: submunitions with biological or chemical weapons, nuclear warheads with anti-simulation balloon

decoys, and nuclear warheads with cooled shrouds. We find that any of these would defeat the planned NMD system. They would either significantly degrade the effectiveness of the defense or make it fail completely. Moreover, these countermeasures would defeat the planned NMD system *even if they were anticipated by the United States*. And because these countermeasures use readily available materials and straightforward technologies, any emerging missile state could readily construct and employ them.

Submunitions with Biological or Chemical Weapons.

To deliver biological or chemical weapons by long-range ballistic missile, an attacker could divide the agent for each missile among a hundred or more small warheads, or submunitions, that would be released shortly after boost phase. These submunitions would be too numerous for a limited defense—such as the planned NMD system—to even attempt to intercept all of them.

Our analysis demonstrates that the attacker could readily keep the reentry heating of the submunitions low enough to protect the agents from excessive heat. Moreover, because submunitions would distribute the agent over a large area and disseminate it at low speeds, they would be a more effective means of delivering biological and chemical agents by ballistic missile than would a single large warhead. Thus, an attacker would have a strong incentive to use submunitions, aside from any concerns about missile defenses.

Nuclear Weapons with Anti-simulation Balloon Decoys.

Anti-simulation is a powerful tactic in which the attacker disguises the warhead to make it look like a decoy, rather than attempting the more difficult task of making every decoy closely resemble a specific warhead.

To use this tactic, the attacker could place a nuclear warhead in a lightweight balloon made of aluminized mylar and release it along with a large number of similar, but empty balloons. The balloon containing the warhead could be made indistinguishable from the empty ones to all the defense sensors—including the ground-based radars, the satellite-based infrared sensors, and the sensors on the kill vehicle. The defense would therefore need to shoot at all the balloons to prevent the warhead from getting through, but the attacker could deploy so many balloons that the defense would run out of interceptors.

Nuclear Weapons with Cooled Shrouds. The attacker could cover a nuclear warhead with a shroud cooled to a low temperature by liquid nitrogen. The cooled shroud would reduce the infrared radiation emitted by the warhead by a factor of at least one million. This would make it nearly impossible for the kill vehicle's heat-seeking infrared sensors to detect the warhead at a great enough distance to have time to maneuver to hit it.

(2) Many operational and technical factors make the job of the defense more difficult than that of the attacker.

First, the defense must commit to a specific technology and architecture before the attacker does. This permits the attacker to tailor its countermeasures to the specific defense system. Second, the job of the defense is technically much more complex and difficult than that of the offense. This is especially true for defenses using hit-to-kill interceptors, for which there is little margin for error. Third, the defense must work the first time it is used. Fourth, the requirements on defense effectiveness are very high for a system intended to defend against nuclear and biological weapons—much higher than the requirements on offense effectiveness.

These inherent offensive advantages would enable an attacker to compensate for US technical superiority.

(3) The planned NMD system would not be effective against an accidental or unauthorized attack from Russia, or an erroneous launch based on false warning of a US attack.

Russia has indicated it would respond to a US NMD deployment by deploying countermeasures on its ballistic missiles. As a result, if an accidental, unauthorized, or erroneous Russian attack should occur, the missiles launched would have countermeasures that would defeat the planned NMD system. Moreover, because of the structure of its command system, an unauthorized Russian attack could easily involve 50 or even 500 warheads, which would overwhelm a limited defense. An erroneous attack would likely be large and would also overwhelm a limited defense.

(4) The planned NMD system would not be effective against a Chinese attack.

China has also indicated it would take steps to permit it to penetrate the planned NMD system. China would likely respond by deploying more long-range missiles

capable of reaching the United States. More significantly, as the 1999 National Intelligence Estimate notes, China has developed numerous countermeasures. The United States must therefore expect that any Chinese ballistic missile attack—whether using existing or new missiles—would be accompanied by effective countermeasures.

(5) Long-range missiles would be neither the only nor the optimum means of delivery for an emerging missile state attacking the United States with nuclear, biological, or chemical weapons.

Other delivery options available to emerging missile states would be less expensive, more reliable, and more accurate than long-range missiles. Moreover, these means could be covertly developed and employed, so that the United States might be unable to identify the attacker and retaliate. These alternative methods of delivery include cruise missiles or short-range ballistic missiles launched from ships off the US coast, nuclear weapons detonated in a US port while still in a shipping container in a cargo ship, and cars or trucks disseminating chemical or biological agents as they are driven through a city.

(6) Available evidence strongly suggests that the Pentagon has greatly underestimated the ability and motivation of emerging missile states to deploy effective countermeasures.

There are strong indications that the Pentagon's Systems Threat Assessment Requirement (STAR) Document and Operational Requirements Document, which describe the type of threat the NMD system must defend against, underestimate the effectiveness of the countermeasures that an emerging missile state could deploy and thus inaccurately describe the actual threat. If the threat assessment and requirements documents do not accurately reflect the real-world threat, then an NMD system designed and built to meet these less demanding requirements will fail in the real world.

(7) The planned testing program for the NMD system is inadequate to assess the operational effectiveness of the system.

A judgement that the planned NMD system can work against realistic countermeasures must be based on sound analysis of the performance of the planned system against feasible countermeasures designed to defeat it.

Should such an analysis indicate that the NMD system may be able to deal with such countermeasures, a rigorous testing program that incorporates realistic countermeasures should be created to assess the operational effectiveness of the planned NMD system. The United States should demonstrate that the system could overcome such countermeasures before a deployment decision is made.

Because it may be difficult or impossible to obtain direct information about the countermeasure programs of other states, the United States must rely on other means—particularly on “red team” programs that develop countermeasures using technology available to emerging missile states—to assess the countermeasure capabilities of potential attackers. However, existing red team programs are under the financial control and authority of the Ballistic Missile Defense Organization and thus face a fundamental conflict of interest.

To permit a meaningful assessment of the operational effectiveness of the NMD system, the NMD testing program should be restructured. The testing program must

- ensure that the baseline threat is realistically defined by having the STAR document reviewed by an independent panel of qualified experts
- conduct tests against the most effective countermeasures that an emerging missile state could reasonably be expected to build
- use an independent red team to design and build these countermeasures, and employ them in tests without the defense having advance knowledge of the countermeasure characteristics
- conduct enough tests against countermeasures to determine the effectiveness of the system with high confidence
- provide for objective assessment of the design and results of the testing program by an independent standing review committee

(8) Past US missile defense tests against missiles using “countermeasures” did not demonstrate that defenses could defeat such countermeasures.

The United States has conducted several missile defense flight tests of exoatmospheric hit-to-kill interceptors that included decoys or other countermeasures and that have been described as demonstrating that the

defense could defeat the countermeasures. However, in every case in which the defense was able to distinguish the mock warhead from the decoys, it was only because it knew in advance what the distinguishing characteristics of the different objects would be. These tests reveal nothing about whether the defense could distinguish the warhead in a real attack, in which an attacker could disguise the warhead and deploy decoys that did not have distinguishing characteristics.

(9) NMD deployment would result in large security costs to the United States.

By deploying an ineffective NMD system, the United States would stimulate responses that would produce a net decrease in its national security.

- *Deployment would make it far more difficult to reduce the greatest threat to the security of the United States: an accidental, unauthorized, or erroneous attack from Russia.*
Current US and Russian nuclear weapons deployment and operational policies, which remain largely unchanged since the end of the cold war, carry a risk of accidental, unauthorized, or erroneous attack on the United States. Today, such an attack poses the gravest threat to the United States: it would likely result in the deaths of millions of Americans. Even a deliberate nuclear attack by an emerging missile state would result in far fewer deaths and injuries.
If the United States deploys its planned NMD system, Russia is likely to increase its reliance on a launch-on-warning strategy, thereby heightening the risk of accidental, unauthorized, or erroneous attack. As Russia has made clear, a US NMD deployment would also limit deep reductions in Russian nuclear weapons, thereby insuring that this threat to US security continues into the future. Deployment would also limit US-Russian cooperation on reducing the dangers posed by Russian nuclear weapons and the risk of theft of Russian nuclear materials.
- *US deployment will affect both the pace and scale of China’s missile modernization program, and is likely to lead China to build up both faster and to higher levels than it otherwise would.*
- *The adverse implications of NMD deployment by the US would extend beyond the direct responses by Russia and China.*

The deployment of the NMD system could seriously impair efforts to control the proliferation of long-range ballistic missiles and weapons of mass destruction, and thus ultimately increase the threat to the United States from these weapons. Controlling proliferation of these weapons requires the cooperation of Russia and China, which, as the 1999 National Intelligence Estimate stated, will be influenced by their perceptions of US ballistic missile defenses. Moreover, as long as the United States and Russia rely on nuclear deterrence, NMD deployment would place a floor on US-Russian nuclear arms reductions, and thereby put at risk the survival of the broader arms control and non-proliferation regimes. Statements by key US allies reflect their concerns that NMD deployment would decrease international security as well as complicate relations within NATO.

(10) Deterrence will continue to be the ultimate line of defense against attacks on the United States by missiles armed with weapons of mass destruction.

The United States, in concert with other countries, can reduce the missile threat through a combination of export controls and various cooperative measures. If a hostile emerging missile state acquires intercontinental-range missiles, the United States can deter their use through the threat of overwhelming retaliation. If such a state makes an explicit and credible threat to launch a missile attack against the United States, it may be possible to destroy its missiles before they are launched, in accord with the right of self-defense.

The only practical and effective way to address the Russian and Chinese missile threat to the United States is through cooperation, and the deployment of the planned NMD system may limit such cooperation.

Chapter 1

Introduction

“It certainly cannot be concluded that an attacker will merely use simple warheads, letting his ballistic missiles perform like high-altitude research vehicles. We must expect that the warhead will be protected by countermeasures against the AMM [anti-missile missiles]: including decoys, missiles launched in front of the actual ICBM, and expandable radar reflectors ejected from the ICBM afterbody or from the reentry body itself. ... The reentry body itself might be supercooled by refrigerants before reentry to upset the infrared detectors.”

—from a book on long-range ballistic missiles published in 1961¹

The United States plans to decide in fall 2000 whether to begin deployment of a national missile defense (NMD) system to defend US territory from limited attacks by intercontinental-range ballistic missiles armed with nuclear, chemical, or biological weapons. Such attacks could include a deliberate attack by an emerging missile state that acquires long-range missiles in the future, an accidental or unauthorized attack by Russia, or an attack by China. In anticipation of such deployment, the United States has begun negotiations with Russia to change the terms of the Anti-Ballistic Missile (ABM) Treaty to permit the deployment to take place within the framework of the treaty.

The United States has conducted extensive research and development on various types of missile defense technologies for decades. Because the Pentagon is now developing a specific system for deployment, the architecture of this system is—by necessity—now relatively firm, although it is not finalized. In particular, the United States has decided what type of interceptor and sensors it will use. The NMD system would use ground-based interceptor missiles to launch kill vehicles intended to destroy targets by colliding with them in the mid-course of their trajectory, outside the earth’s atmosphere. The system would use ground-based radars and space-based infrared and visible sensors, and the kill vehicle would be equipped with infrared and

visible sensors. In addition, as prototypes of the defense components are built, more information has become available about the technical characteristics of this hardware.

For the first time in decades, there is a relatively well defined NMD system under consideration for deployment. The decision the US administration plans to make in fall 2000 is whether to begin deployment of this particular system.

Purpose of the Study

It is a common assumption that the planned NMD system would “work” against a limited missile attack, particularly one launched by an emerging missile state. In this report, we examine this assumption in detail: we assess the likely operational effectiveness of the planned NMD system against a limited long-range missile attack on the United States. We pay particular attention to the most commonly cited threat, namely, an attack by an emerging missile state.

The question “Will it work?” can only be answered in the form “Will it work against what?” In other words, the operational effectiveness of any defense system would depend on the characteristics of the threat that it had to counter.

The discussion of the ballistic missile threat to the United States has focused on the number of missiles the NMD system might need to defend against. While the size of the attack would have a significant effect on

¹ Eric Burgess, *Long-Range Ballistic Missiles*, (London: Chapman & Hall, 1961), p. 199.

the operational effectiveness of the planned NMD system, of equal or greater importance would be what steps the attacker took to counter the defense. The attacker could take “countermeasures” to deliberately confuse, overwhelm, or otherwise defeat the defense.

While there is evidence of missile development programs in several emerging missile states, there is little or no direct evidence of countermeasure programs, which would be much more difficult to observe in these countries. In part because little is known about the countermeasure programs of emerging missile states, there has been little public discussion and even less analysis of this important issue, which is crucial to making an informed deployment decision. But as the Rumsfeld Commission emphasized in its analysis of the potential evolution of missile programs in emerging missile states: the absence of evidence is not evidence of absence.²

Indeed, as the 1999 National Intelligence Estimate (NIE) on the ballistic missile threat to the United States noted, “countries developing ballistic missiles would also develop various responses to US theater and national defenses.” The NIE also stated that “these countries could develop countermeasures... by the time they flight test their missiles.”³

This NIE assessment makes very good sense. After all, US missile defense policy is based on the assumption that an emerging missile state could acquire long-range missiles and warheads to arm them with and would have the motivation to use or threaten to use them against the United States. Given these assumptions, the United States must also assume that such an attacker would have the motivation to develop and deploy countermeasures. It would be nonsensical to assume that a country would spend the resources and devote years to develop and deploy long-range missiles to attack or threaten the United States, and yet would not have a parallel—though smaller and less expensive—effort to develop countermeasures to allow these missiles to remain effective in the face of US defenses. This assumption would be especially nonsensical since US plans to deploy an NMD system are front-page news.⁴

² Executive Summary, *Report of the Commission to Assess the Ballistic Missile Threat to the United States (Rumsfeld Commission Report)*, 15 July 1998.

³ National Intelligence Council, “National Intelligence Estimate (NIE): Foreign Missile Development and the Ballistic Missile Threat to the United States Through 2015,” unclassified summary, September 1999, p. 16.

⁴ A country that had acquired missiles from another country rather than develop them indigenously must be assumed to

So the real issues are: (1) what countermeasures would be within the technical capability of a country that deployed long-range ballistic missiles and warheads, and (2) how effective would the planned NMD system be in the face of such countermeasures?

Our analysis is based on thinking, because observing is not possible. Such analysis is sometimes referred to as “think-intelligence” or “THINKINT,” in contrast to more physical types of intelligence, such as that acquired by satellites or intelligence agents. The purpose of this study was to draw together a group of technical experts to conduct THINKINT on countermeasures.

Thus, our study analyzes countermeasures in the spirit of the Rumsfeld Report, which conducted THINKINT on future missile threats but not on countermeasures that would accompany such missiles. However, it is important to note that our study makes more conservative assumptions about the technical capabilities of emerging missile states than the Rumsfeld Committee did. The Rumsfeld Report was essentially a worst-case assessment of the future missile threat to the United States; it considered how quickly an emerging missile state could acquire long-range missiles if it devoted the needed resources to the program. In contrast, our study does not ask what would be the most advanced countermeasures that an emerging missile state could develop and deploy, but what would be the technically simplest countermeasures that might be effective, and what effect they would have on the operational effectiveness of the planned NMD system.

We consider the range of technologies and strategies that an attacker using long-range missiles could take to counter the US national missile defense system and examine in detail several such countermeasures that would be readily available to an emerging missile state. We conclude that these countermeasures thus constitute a real-world baseline threat that must be used to assess the operational effectiveness of the planned NMD system.

Scope of the Study

To answer the question “Will it work?” we perform a reasonable best-case analysis for the defense. It is a “best-case” analysis because we assume the United States successfully controls those aspects of the engagement that it has control over: we assume that the components of the NMD system will work as they are designed to—that their performance is limited by the

be able to acquire countermeasure technology as well, as discussed in the NIE, p. 16.

laws of physics, geometry, and geography, but not by quality control problems or engineering difficulties. It is a “reasonable” analysis because we define the baseline threat by assuming the attacker will take at least minimal steps to counter the NMD system.

We have focused our analysis on the NMD system that is currently being planned for deployment. There are many possible architectures and technologies that could be employed in a limited NMD system. Indeed, some of these technologies are still under research and development by the United States. However, because these technologies will not be part of the NMD system that the United States will make a decision about in 2000, they are not our primary interest in this report.

The stated goal of the NMD system is initially to protect all 50 US states from an attack by a few tens of missiles with simple countermeasures from North Korea and from an attack by a few missiles with simple countermeasures from the Middle East. The full system is intended to defend against an attack of up to a few tens of long-range missiles with complex countermeasures launched from either North Korea or the Middle East.⁵

Thus, in our analysis, we consider the effectiveness of the full NMD system against attacks by a few tens of missiles with countermeasures.

Criteria for Deployment

The Clinton administration has stated that it will use several criteria in making its deployment decision. It will consider

- (1) the changing threat from emerging missile states and the anticipated need for an NMD system
- (2) the cost of deployment
- (3) the effect of NMD deployment on US-Russian nuclear arms reduction process and the broader strategic environment
- (4) the “technological readiness” of the system for deployment.

The Pentagon will assess the fourth criteria in a “deployment readiness review” (DRR), which is scheduled to be conducted in summer 2000. It will base its assessment of the technological readiness in large part on the results of three intercept tests that are scheduled to take place prior to the review. In the first of these

⁵ Walter B. Slocombe, Undersecretary of Defense for Policy, Testimony to the House Armed Services Committee, 13 October 1999.

tests, which took place on 2 October 1999, the interceptor hit its target but questions remain about the homing process (see Chapter 11). In the second intercept test, on 18 January 2000, the interceptor missed its target. The third test is scheduled for June 2000.

However, “technological readiness” appears to have been narrowly defined to mean whether the system can intercept a mock warhead on the test range with no credible countermeasures.⁶ Thus, there is a fifth criterion that must be taken into account in making this deployment decision: the likely operational effectiveness of the planned NMD system against a real-world attack. A real-world attack would include countermeasures.

The issue of operational effectiveness is a more important criterion than is technological readiness. A weapons system can be “technologically ready” and still inadequate to defend against a responsive adversary—that is, an adversary that designs or modifies its forces taking into account the capabilities of the weapons system.

While intercepting *any* long-range missile warhead on the test range is an impressive technical feat, it is not sufficient. Operational effectiveness is the more demanding, but also the only meaningful, requirement. The intercept tests to be conducted prior to the scheduled deployment decision date in fall 2000 will not assess operational effectiveness of the planned NMD system.

Some NMD proponents acknowledge that neither these intercept tests nor the upcoming deployment readiness review will assess the operational effectiveness of the planned system against countermeasures. However, they argue that if these intercept tests demonstrate that the basic technology works, the United States should deploy the first stage of the system and then upgrade it so that the fully deployed NMD system would be able to deal with countermeasures.

However, since the real-world threat would include countermeasures, then the criterion for deployment must be whether the fully deployed system would be able to deal with these countermeasures—not the much more narrow criterion of whether the system can intercept cooperative targets on the test range. In particular, if there are countermeasures that would be available to

⁶ The deployment readiness review will only assess the technological readiness of the first phase of the NMD system—the so-called Capability-1 (C-1) phase (see Chapter 3). See “Director of Operational Test and Evaluation, FY 1999 Annual Report,” submitted to Congress February 2000, p. VI-7, available online at www.dote.osd.mil/pubs.html.

emerging missile states and would defeat the full NMD system, then it would make no sense for the United States to begin deploying even the first stage of this system until it demonstrates—first on paper and then on the test range—that the full system could be made effective against such countermeasures.

Sources and Methods

This report, and the analysis it describes, is based solely on information available in the open literature. It may surprise some readers how much information about the planned NMD system is available. We have obtained information from a variety of sources, including news reports, congressional briefings, and statements of US government officials. All the references we have used are included in footnotes.

Although there are many aspects of the NMD system that are classified—and properly so—the classified information generally has to do with specific details. Of course, the laws of physics cannot be classified. Our work is based on these general laws of physics combined with material from the open literature. We do not believe that access to classified information would in any significant way alter the conclusions of our report.

We also note that the technical information we use in our analysis—and much more—would be available to any country that was building long-range missiles. One must expect that any country seeking to attack the United States with ballistic missiles would expend much effort, time, and resources on understanding the NMD system and developing countermeasures. Indeed, their effort would exploit far greater resources than we have had at our disposal for the analysis presented in this report.

The Structure of This Report

In Chapter 2 of this report, we review the likely ballistic missile threats the United States could face in the next decades, including those from Russia, China, and emerging missile states.

In Chapter 3 we describe the architecture and components of the planned National Missile Defense System (NMD); more technical details about the system are given in the appendices.

We then discuss, in Chapter 4, the operational and technical factors that would give an attacker using ballistic missiles an advantage over a defender. In Chapter 5 we discuss the past and current countermeasure programs in the United States, Britain, France, Russia, and China. This discussion is based in part on what is publicly known about the countermeasures to missile defenses that the other nuclear-weapon states, including the United States, have developed and in some cases deployed on their intercontinental-range ballistic missiles.

In Chapter 6 we briefly review the types of countermeasures that could be used by an emerging missile state to complicate the task of the planned NMD system. These countermeasures use readily available materials and straightforward technologies; they would be available to any emerging missile state that deployed long-range missiles. In Chapters 7 through 9 we examine three of these countermeasure options in detail. In these chapters, we discuss our technical analysis of submunitions for delivery of biological and chemical weapons; anti-simulation balloon decoys for a nuclear warhead; and a cooled shroud for a nuclear warhead. Based on our technical analysis, we find that these countermeasures would prevent the planned NMD system from being able to defend against even a limited attack.

We examine the planned testing program of the NMD system in Chapter 10 and conclude that it is not adequate to assess the operational effectiveness of the planned NMD system. In addition, we discuss the elements of an adequate, and rigorous, testing program that would allow the United States to assess the operational effectiveness of the planned NMD system. In Chapter 11, we review past missile defense flight tests that have been described as including countermeasures. We show that none of these tests actually demonstrated any capability to deal with real-world countermeasures.

In Chapter 12 we move away from the narrow considerations of the technical aspects of the planned NMD system to the strategic aspects, i.e., we consider the likely reactions of other states to the deployment of a US NMD system and the resulting security costs to the United States of deployment.

Finally, in Chapter 13 we consider alternative ways of addressing missile threats to the United States.

Chapter 2

The Existing and Emerging Ballistic Missile Threat to the United States

A deliberate ballistic missile attack by Russia—the threat the United States faced during the Cold War and the one the Strategic Defense Initiative (SDI) was intended to counter—is now discounted both as implausible and as too difficult to defend against in any event. The planned US national missile defense system is neither intended nor designed to address this threat. Instead, three other types of possible ballistic missile threats to the United States are now cited to justify the rapid development and deployment of an NMD system. The first of these threats is an accidental, unauthorized, or erroneous attack by Russia. The second is an attack by China, whether accidental, unauthorized, erroneous, or deliberate. The third is the potential future missile threat from developing countries with hostile intentions; this is the threat that is the most commonly cited to demonstrate a need for national missile defenses. Below, we review in turn these three missile threats.

The probability that any of these threats would actually lead to a ballistic missile attack on US territory is unknowable, both in relative and absolute terms. However, an accidental, unauthorized, or erroneous attack from Russia would almost certainly result in many more deaths and far more damage to the United States than either an attack from China or an attack from an emerging missile state.

An Accidental, Unauthorized, or Erroneous Launch by Russia

Although Russia's arsenal of nuclear-armed ballistic missiles has decreased since the end of the Cold War, it remains large (see Table 2-1) and its destructive capability has not diminished substantially. Moreover, the deteriorating state of the Russian economy is believed to extend to at least some extent to its nuclear

forces and its nuclear command and control systems. This has led to concern that Russia's nuclear-armed missiles might be launched accidentally (for example, due to equipment failure or operator error), by one or a few individuals acting without authorization, or deliberately due to an erroneous warning of an incoming US attack.

The threat of an accidental, unauthorized, or erroneous Russian launch is real, but its likelihood is difficult to assess since this depends on details of Russia's command and control systems, its operational practices, and its launch policies.

However, it is possible to identify several technical and political factors that would make such launches more or less likely. These factors include

- (1) the extent to which Russia maintains a launch-on-warning option and thus maintains its ballistic missiles on high alert levels
- (2) the extent to which Russia's early warning system can reliably provide warning of an incoming missile attack without producing false alarms
- (3) the likelihood that Russia would actually launch its forces on warning of an incoming US attack, which would in turn depend on the state of the US-Russian relationship
- (4) the extent to which Russia's command and control system protects against unauthorized launches

Despite the end of the Cold War, the United States and Russia continue to rely on nuclear deterrent policies that are based on deploying large numbers of nuclear-armed missiles on high alert levels. The only

Table 2-1. Russian Missile-Based Strategic Nuclear Forces, End of 1998.

A. Intercontinental Ballistic Missiles (ICBMs)

Missile	Number of Missiles Deployed	Warheads per Missile	Total Warheads	Yield of Warheads (kilotons)
SS-18	180	10	1,800	550/750
SS-19	160	6	960	550
SS-24 (Rail Mobile)	36	10	360	550
SS-24 (Silo-Based)	10	10	100	550
SS-25	360	1	360	550
SS-27	10	1	10	550
TOTAL	756		3,590	

B. Submarine-Launched Ballistic Missiles (SLBMs), End of 1998

Missile	Number and Type of Operational Submarines	Missiles per Submarine	Warheads per Missile	Warheads per Submarine	Total Warheads	Yield of Warheads
SS-N-18	11 Delta III	16	3	48	528	500
SS-N-20	3 Typhoon	20	10	200	600	200
SS-N-23	7 Delta IV	16	4	64	448	100
TOTAL	21 subs				1,576	

Total Russian ICBM and SLBM Warheads: 5,166

Source: NRDC Nuclear Notebook, "Russian Strategic Nuclear Forces, End of 1998," Bulletin of Atomic Scientists, Vol. 55, No. 2, March/April 1999, pp. 62-63.

reason for either country to deploy weapons on high alert is to permit the rapid launch of these weapons in response to information from its early warning system that the other country has launched an attack, to preclude the possibility that such an attack might destroy their nuclear weapons or their command and control system before the weapons could be launched in retaliation. Thus, the likelihood of an erroneous Russian attack depends in part on the extent to which Russia is concerned about the survivability of its ballistic missiles in the face of a US counterforce first strike.

Even if the START II and III agreements are implemented, the United States will retain large numbers of highly-accurate ICBMs and submarine-launched

ballistic missiles (SLBMs), with considerable first-strike capabilities against Russia's nuclear forces. Of particular concern to Russia are the highly accurate Trident II SLBMs, which can destroy even heavily hardened targets and which could potentially exploit gaps in the crumbling Russian early warning system to do so with little or no warning. In addition, US nuclear-powered attack submarines continue to operate near Russian ballistic missile submarine bases, posing a direct threat to the few missile submarines Russia is able to maintain at sea at any given time.

Clearly, if Russia maintains some of its ballistic missiles on high alert levels and has a policy to launch these missiles in response to warning of an incoming US missile attack, and if its early warning system is not adequate to provide reliable warning of such an attack, this increases the likelihood that Russia would launch an erroneous attack based on faulty information from its early warning system. Unfortunately,

Russia's early warning system is crumbling and currently has gaps in its coverage.¹

Maintaining forces on high alert levels for rapid launch also reduces the margins for error, thus increasing the risk of error. A human or technical problem that might otherwise be detected and corrected could lead to disaster under the severe time pressures associated with a rapid launch requirement. And it is easier for someone to launch an unauthorized attack if only a few steps are needed to do so. Thus, high alert levels increase the risk of accidental and unauthorized launches as well as erroneous launches.

¹ David Hoffman, "Russia's Missile Defenses Eroding," *Washington Post*, 10 February 1999.

What would be the probable scale of an attack, should one occur? Depending on where in the command and control system an accident or other problem occurs, an accidental launch could, in principle, involve a single missile, or it could be much larger. A technical malfunction could cause the accidental launch of a single missile or of a significant portion of Russia's nuclear missile force.

However, the architecture of Russia's command system is such that an unauthorized launch is unlikely to be small, with knowledgeable estimates of such a launch ranging from 60 to 520 warheads.

The Ballistic Missile Defense Organization (BMDO), in a report to the House National Security Committee on various national missile defense options, states that a Russian unauthorized attack could vary in size from 60 to 200 warheads. The report notes that "The 60 RV [reentry vehicle] threat represents an attack by a commander in a country like Russia with larger nuclear forces; the resources are those of a land based squadron or submarine. The 200 RV attack is the largest that a single Russian commander could control; it matches what is said to be aboard a Typhoon submarine."²

Indeed, a Russian regiment of SS-18 missiles is typically six missiles with ten warheads each, for a total of 60 warheads. However, according to Bruce Blair,³ all Russian ICBMs in a division are interconnected and can be launched by any of the regimental launch control centers or by division command posts and their alternates in the field. Thus, a regiment commander who devises a way to launch the six missiles under his or her control, can also plausibly fire all the missiles in the interconnected regiments. The total number of missiles and warheads in any given SS-18 field (of which there are four in Russia today) ranges from 30 to 52 missiles armed with 300 to 520 warheads. (This redundant launch configuration is similar to the US Minuteman and MX fields, where a single flight of ten missiles under the launch control of one launch control center is interconnected to the other four flights of missiles in the squadron.) Thus, an unauthorized launch of Russian ICBMs could just as easily involve 300 to 520 warheads as it could 60.

As the BMDO report notes, one plausible scenario for an unauthorized attack would be the launch of

missiles from a single Russian submarine. Currently Russia keeps typically two SSBNs at sea (usually one Delta-IV in the Northern Fleet and one Delta-III in the Pacific fleet), in addition to one or two submarines (sometimes including Typhoons) on dockside alert able to launch their missiles 9 to 12 minutes after receipt of a launch order.⁴ However, it is expected that the Typhoons will soon be retired from the Russian Navy and that the Russian submarine force will consist of Delta-IV submarines (each carrying 64 warheads) and Delta-III submarines (each with 48 warheads). These Russian SLBMs have a range that would allow them to reach the United States even while they are in port, thus they will continue to present a day-to-day threat of unauthorized attack even if Russia is not able to maintain its submarines at sea.

Although such estimates of an unauthorized Russian attack suggest it could involve up to 520 warheads, even one that involved only 60 warheads would surely lead to millions of deaths. One recent study estimated that if only 20 US W88 Trident II warheads (each with a yield of 475 kilotons) were targeted on the 12 largest Russian cities so as to maximize casualties, 25 million people would be killed.⁵ Another study considered the fatalities that would be produced if one Russian Delta-IV ballistic-missile submarine launched its 16 missiles against a variety of governmental, military, industrial, transportation, and other targets in and near eight major US cities.⁶ Even though this study assumed that 4 of these 16 missiles malfunctioned, that the missiles were not targeted to maximize casualties, and that the warheads had a smaller yield of 100 kilotons, it concluded that almost 7 million people would be killed immediately, while millions of others could be exposed to potentially lethal radiation from fallout.

Finally, for erroneous launches, there is also reason to believe that a large-scale attack would be more probable than a small one. In fact, a retaliatory attack erroneously launched in response to false or ambiguous information could be very large—as many as thousands of warheads.

² Ballistic Missile Defense Organization, "National Missile Defense Options," prepared in response to request from House National Security Committee, 31 July 1995, p. 4.

³ Bruce Blair, Brookings Institution, personal communication, June 1999.

⁴ Bruce Blair, personal communication, June 1999.

⁵ Committee on International Security and Arms Control, National Academy of Sciences, *The Future of US Nuclear Weapons Policy*, (Washington, D.C.: National Academy Press, 1997), p. 43 (box 2.2).

⁶ Lachlan Forrow, M.D., et al., "Accidental Nuclear War—A Post-Cold War Assessment," *The New England Journal of Medicine*, Vol. 338, No. 18, 30 April 1998, p. 1326.

Size of the Future Russian Nuclear Arsenal.

Some argue that, because of its economic crisis, Russia will be unable to maintain a large nuclear arsenal over the next one to two decades. Thus, according to this argument, the size of the Russian nuclear arsenal will drop dramatically, possibly to as low as 1,000 or fewer warheads, regardless of what the United States does. However, even if true, a reduction in the size of the Russian arsenal would not by itself substantially affect the probability of a Russian accidental, unauthorized, or erroneous attack. The probability of such an attack could actually increase if Russia sought to compensate for its lower force levels by increasing the fraction of its forces maintained on a launch-on-warning status.

Nevertheless, the size of Russia's future arsenal is still an important question. The 1999 National Intelligence Estimate (NIE) on "Foreign Missile Development and the Ballistic Missile Threat to the United States Through 2015," which represents the consensus of the US intelligence community, concludes in its unclassified summary that "By 2015, Russia will maintain as many nuclear weapons as its economy will allow but well short of START I or II limitations."⁷ (START I limits Russia to roughly 6,000 deployed warheads, and START II to 3,000 to 3,500.) However, this conclusion assumes that the START II agreement, which Russia has not yet ratified, is in force. As the NIE also notes, if Russia does not ratify or adhere to the START II limits, it would probably be able to maintain twice as many warheads as it could under START II, since this treaty bans the types of weapons Russia has most of: multiple warheads on ICBMs.⁸

In fact, two recent authoritative studies—one US and one Russian—conclude that despite its economic problems, Russia can maintain a force of 3,000 to 4,000 nuclear warheads for 10 to 20 years, if it ignores the restrictions imposed by the START II treaty, as it might be expected to do if the US proceeds with plans to build an NMD system, and if it carries out modernization and life-extension programs for its forces that appear to be reasonable and realistic.

Dean Wilkening of Stanford University uses a detailed model to estimate future Russian arsenal size.⁹ He concludes that Russia has both the desire and capability to maintain a strategic arsenal of about 4,000 strategic nuclear warheads for the next two decades, if it abides by the START I agreement but not START II. He writes:

Although many issues are hotly debated in Russia's current military reform, there appears to be remarkable consensus that strategic nuclear force modernization will receive high priority relative to other pressing defense needs—despite the fact that conventional forces may be better suited to Russia's future security needs. . . . Nevertheless, the argument is made that with relatively weak conventional forces, Russia must place greater reliance on nuclear weapons for its security, just as the United States did in the 1950s. While this will involve an emphasis on tactical nuclear weapons, considerable emphasis will be placed on strategic nuclear forces as well. This is due, in part, to the fact that strategic nuclear forces are the *sine qua non* of great-power status and, in part, to their role as a deterrent to unforeseen threats that might develop in the future (e.g., more aggressive NATO expansion, etc.).¹⁰

He concludes:

Numerous uncertainties, especially financial uncertainties, prevent accurate estimates of Russia's future strategic force. Nevertheless, Russia can probably maintain a force with slightly more than 4,000 strategic nuclear warheads over the next two decades under the START I Treaty. This is about half the number of strategic warheads the United States could, in principle, maintain. Under START II, Russia is likely to maintain a strategic force between 1,800 and 2,500 warheads, compared to up to 3,500 warheads for the United States.¹¹

Similarly, a Russian researcher, Pavel (Paul) Podvig of the Center for Arms Control at the Moscow Institute of Physics and Technology, estimated the size of the arsenal Russia could maintain through 2008, which is the date by which the United States and Russia are required to complete reductions under the START II

⁷ National Intelligence Council, "National Intelligence Estimate (NIE): Foreign Missile Development and the Ballistic Missile Threat to the United States Through 2015," unclassified summary, September 1999, p. 4.

⁸ National Intelligence Council, "NIE: Foreign Missile Development" states "If Russia ratifies START II, with its ban on multiple warheads on ICBMs, it would probably be able to maintain only about half of the weapons it could maintain without the ban," p. 11.

⁹ Dean Wilkening, *The Evolution of Russia's Strategic Nuclear Force*, Center for International Security and Cooperation Report, July 1998.

¹⁰ Wilkening, *The Evolution of Russia's Strategic Nuclear Force*, p. 2.

¹¹ Wilkening, *The Evolution of Russia's Strategic Nuclear Force*, p. 42.

treaty.¹² He assumes that Russia will be able to continue its development and production programs at their current level, which he believes is moderate. He also assumes that Russia will continue its efforts aimed at extending the operational lives of its deployed strategic weapons. He concludes that Russia could maintain a strategic nuclear force of 3,000 to 4,000 weapons at least through 2008.

An Accidental, Unauthorized, Erroneous, or Deliberate Attack by China

China currently deploys roughly 20 single-warhead ICBMs with a range capable of reaching the United States (see Table 2-2).¹³ However, at present the probability that China would launch an accidental, unauthorized, or erroneous attack against US territory is essentially zero because all Chinese ICBMs capable of reaching the United States apparently have their warheads and fuel stored separate from the missiles.¹⁴

This situation could change in the future since China is believed to be planning to deploy a solid-fueled road-mobile ICBM, the DF-31. China conducted the first flight test of this missile in August 1999. The US intelligence community believes it will have a range of about 8,000 kilometers (which would be adequate to reach parts of the United States, such as Alaska) and will be targeted primarily against Russia and Asia.¹⁵ In addition, China may deploy a longer-ranged solid-fueled road-mobile missile, the DF-41, in another decade. The US intelligence community expects a flight test of this missile within the next several years.¹⁶ Because China's

motive for deploying these mobile missiles is apparently to provide it with a more survivable deterrent, it is possible that these missiles will be deployed with their warheads.

In any event, because China has no early warning system to detect incoming missiles, it does not have the capability to "launch on warning." Thus, China has two options: it could plan to attack first if it believed another country was planning to attack, or it could plan to wait until after incoming missiles had landed on Chinese territory before retaliating. In the latter case, it is unlikely that China would launch an attack based on erroneous information because it would be clear whether or not a nuclear weapon had exploded on Chinese territory. What may be less clear to China, since it does not have an early warning system, is where

Table 2-2. Chinese Missile-Based Intercontinental Nuclear Forces
(Parentheses indicate NATO designation)

Missile	Type	Range	Operational Status	Number Deployed
DF-5A (CSS-4)	ICBM	13,000 km	deployed	20
DF-31	ICBM (road-mobile)	8,000 km	in development	0
DF-41	ICBM (road-mobile)	> 8,000 km	in early development	0
JL-2 (CSS-N-4)	SLBM	8,000 km	in early development	0

Source: NRDC Nuclear Notebook, "Chinese Nuclear Forces, 1999," Bulletin of Atomic Scientists, Vol. 55, No. 3, May/June 1999, pp. 79-80.

the missile had been launched from. Thus, it is in principle possible that China would launch missiles at the United States in response to an attack by another country. However, this scenario is highly unlikely; if a missile were launched at China, then the political context would almost certainly indicate the identity of the attacker.

Because China's one SLBM-armed submarine is infrequently at sea and only patrols close to China, and because the range of Chinese SLBMs is fairly short (approximately 1,700 kilometers), these weapons also do not present a threat of accidental, unauthorized, or erroneous attack on the United States in their normal deployment mode. This is in contrast to the situation with respect to Russian SLBMs, whose long range would allow them to reach the United States even while they are in port, and which therefore do present a threat

¹² Paul Podvig, "The Russian Strategic Forces: Uncertain Future," *Breakthroughs*, Spring 1998, pp. 11-21; Paul Podvig, "The Future of Nuclear Arms Control: A View from Russia," presentation at MIT Security Studies Program, 9 November 1999.

¹³ See also, Bill Gertz, "China Adds 6 ICBMs To Arsenal," *Washington Times*, 21 July 1998, p. 1, and National Intelligence Council, "NIE: Foreign Missile Development," p. 11.

¹⁴ Walter Pincus, "US, China May Retarget Nuclear Weapons," *Washington Post*, 16 June 1998, p. A10.

¹⁵ National Intelligence Council, "NIE: Foreign Missile Development," p. 11.

¹⁶ National Intelligence Council, "NIE: Foreign Missile Development," p.11.

to the United States on a day-to-day basis. This situation could change if China deploys longer-range SLBMs, as it might in the next decade. China has been developing the JL-2 SLBM, which would have a range of 8,000 kilometers and could thus target the United States from launch areas near China. According to the 1999 National Intelligence Estimate, the US intelligence community expects China to test this missile “within the next decade.”¹⁷

Thus, on technical grounds, it appears that the most plausible threat to US territory from China’s ballistic missiles would be a deliberate attack. How likely, then, would China be to launch a deliberate nuclear attack, knowing that it would have to expect a US retaliatory attack?

During the 1995–96 Taiwan crisis, a Chinese official was widely reported to have made a statement that the United States would not be willing to trade Los Angeles for Taiwan;¹⁸ this statement is often cited by those who believe that the threat of a deliberate Chinese attack is real. However, the source of that report, former Assistant Secretary of Defense Charles W. Freeman Jr., believes the context of that remark has been misunderstood. In a public forum in April 1999, he said:

This remark was made toward the end of a five-hour argument in October 1995, between myself and a number of people on the side of China, over what the probable effect of the six military maneuvers the Central Military Commission had authorized in the Taiwan Strait would be. It was my position, which turned out to be correct, that if China carried through with its plans, it would get a good American military reaction. It was the position of the Chinese military officers with whom I was speaking that there would be no American military reaction. They had many arguments for this. At the end of the argument, [which] was very heated, one of them said, “and finally, you do not have the strategic leverage that you had in the 1950s when you threatened nuclear strikes on us, because you were able to do that because we could not hit back. But if you hit us now, we can hit back. So you will not make those threats. In the end you care more about Los Angeles than you do about Taipei.”¹⁹

¹⁷ National Intelligence Council, “NIE: Foreign Missile Development,” p. 11.

¹⁸ “Chinese Issue Attack Warnings Over Taiwan,” *Chicago Tribune*, 24 January 1996, p. 6. See also “Nuclear Warning to US Cited,” *Boston Globe*, 18 March 1996, p. 4. According to the Rumsfeld Report, “...during this crisis a pointed question was raised by Lt. Gen. Xiong Guang Kai, a frequent spokesman for Chinese policy, about the US willingness to trade Los Angeles for Taiwan,” p. 10.

Ambassador Freeman then continued, “Please note the statement is in a deterrent context and it is consistent with no first use. It is not a threat to bomb Los Angeles.” Thus, this statement does not indicate that China would not be deterred by the threat of US retaliation from launching a nuclear attack against Los Angeles. Rather, it indicates that China believes that the United States would not threaten to launch a nuclear attack against China because such a threat would not be credible now that China could retaliate.

Indeed, there is no reason to believe that China is undeterrable. The threat of a deliberate Chinese attack would seem to be extremely small, given the certainty of US retaliation. Nevertheless, a Chinese threat to launch a nuclear attack over an issue of vital national interest to China (i.e., Taiwan) could not be easily ignored.

The Threat from Emerging Missile Powers

No country that is hostile to the United States currently has the capability to strike the United States with a ballistic missile launched from its territory.²⁰ However, there is a possibility that an emerging missile power might acquire such a capability and use it to threaten or actually attack the United States in the near future.

The most detailed publicly available official US assessment of the emerging missile threat to the United States is provided in two documents. The first is the executive summary of the report of the Commission to Assess the Ballistic Missile Threat to the United States (the full report is classified; all references to the report are to the executive summary unless otherwise indicated). Because the commission was chaired by former Secretary of Defense Donald Rumsfeld, the report is known informally as the Rumsfeld report.²¹ The

¹⁹ Statement made during question and answer session of the 30 April 1999 Proliferation Roundtable at the Carnegie Endowment for International Peace on “China’s Changing Nuclear Posture,” transcript available on the CEIP website at www.ceip.org/programs/npp/43099q&a.htm.

²⁰ Only Britain, China, France and Russia currently deploy ballistic missiles capable of reaching the United States from their territory. In addition, Japan, India, Israel, and Ukraine either have launched satellites and/or manufacture space launch vehicles and could presumably convert this space-launch capability into an intercontinental ballistic missile. However, none of these countries are regarded as hostile to the United States.

²¹ Executive Summary, *Report of the Commission to Assess the Ballistic Missile Threat to the United States (Rumsfeld Commission Report)*, 15 July 1998. Referred to hereafter as the Rumsfeld Report. The summary is available online on

second document is the unclassified summary of the 1999 National Intelligence Estimate (NIE) on “Foreign Missile Development and the Ballistic Missile Threat to the United States Through 2015.” As noted above, this estimate represents the consensus of the US intelligence community.

The Rumsfeld report focused on the ballistic missile threats that could emerge, whereas the NIE also considered the likelihood that these various threats would emerge. Both documents focus on three developing countries that may acquire long-range ballistic missiles which could be used to threaten the United States: North Korea, Iran, and Iraq. The Rumsfeld report concluded that North Korea and Iran could acquire the capability to attack the United States with long-range ballistic missiles within five years of a decision to do so, and that Iraq could acquire such a capability within ten years (anticipating the end of UNSCOM inspections in Iraq in late 1998, the commission subsequently changed its estimate to five years for Iraq). Moreover, the Rumsfeld report concluded that for several years the United States might not be aware that such a decision had been made by any of these countries. Thus, according to the Rumsfeld commission, the United States might have little or no warning that a missile threat to US territory was about to emerge. The NIE agreed that the US intelligence community would not be able to provide much warning if a country purchased an ICBM or converted an existing space-launch vehicle to an ICBM, but stated that the community was confident it could provide a warning that a country was developing an ICBM five years prior to the first flight test.²²

Of these three countries, North Korea has the most advanced ballistic missile capabilities. In August 1998, North Korea conducted a flight test of a Taepo-dong-1 (TD-1) three-stage space-launch vehicle that overflew Japan. North Korea claims it was trying to place a satellite in orbit; it did not succeed. At least one problem with this test was that the third stage apparently malfunctioned. However, the test clearly demonstrates that North Korea has gained expertise in staging technology, which is necessary for an ICBM.

According to the NIE, if the Taepo-dong-1 were converted to a ballistic missile, and had an operable third stage as well as a reentry vehicle capable of

surviving ICBM flight and atmospheric reentry, it “could deliver a light payload ... to the United States, albeit with inaccuracies that would make hitting large urban targets improbable.”²³ A converted Taepo-dong-1 could be capable of reaching Alaska, Hawaii, and possibly parts of the West Coast with a small payload of perhaps a few tens of kilograms. This would allow delivery of chemical or biological agents, but not a first-generation nuclear weapon, which would weigh roughly 1,000 kilograms. Thus, assuming North Korea can solve whatever problem it had with this missile, it could have a small-payload ICBM soon.

How long might it take North Korea to develop an ICBM capable of carrying a larger warhead, or with a range adequate to hit additional parts of the United States? The NIE reported that most US intelligence analysts believed that North Korea could have tested its Taepo-dong-2 missile in 1999, and would probably have done so if the program had not been constrained for political reasons. (Following its May 1999 discussions with William Perry, the US policy coordinator for North Korea, North Korea stated it would not flight test any missiles while US-North Korean discussions on limiting the North Korean missile program are ongoing.) According to the NIE, a two-stage Taepo-dong-2 could deliver several hundred kilograms to Alaska and Hawaii or a lighter payload to the western continental United States, and a three-stage Taepo-dong-2 could deliver several hundred kilograms to anywhere in the United States.

After North Korea, Iran is judged to be the potentially hostile developing country whose ballistic missile program is the next most advanced. The NIE states that “Iran *could test* an ICBM that could deliver a several-hundred kilogram payload to many parts of the United States in the latter half of the next decade, using Russian technology and assistance,” but that there is no consensus on whether it is likely to do so.²⁴

Iraq’s missile infrastructure was largely destroyed in the 1991 Gulf War and by subsequent UN activities, but if it resumed its missile program, US intelligence analysts believe it would be capable of developing a (light-payload) ICBM comparable to the North Korean Taepo-dong-2 by the end of the next decade.²⁵

the Federation of American Scientists website at www.fas.org/irp/threat/bm-threat.htm.

²² National Intelligence Council, “NIE: Foreign Missile Development,” p. 12.

²³ National Intelligence Council, “NIE: Foreign Missile Development,” p. 4.

²⁴ National Intelligence Council, “NIE: Foreign Missile Development,” p. 10 (emphasis in the original).

²⁵ National Intelligence Council, “NIE: Foreign Missile Development,” p. 10.

Other Means of Delivery

The Rumsfeld Report noted that the earliest third world ballistic missile threat to US territory might not be one using intercontinental-range missiles, but rather one using forward-deployed shorter-range missiles. Both the Rumsfeld Report and the 1999 NIE state that a country could—without difficulty—launch shorter-range missiles from ships off the US coast. The Rumsfeld Commission observed that, “Sea launch of shorter-range ballistic missiles is another possibility. This could enable a country to pose a direct territorial challenge to the US sooner than it could by waiting to develop an ICBM for launch from its own territory. Sea launching could also permit it to target a larger area of the US than would a missile fired from its home territory.”^a Specifically, it stated that “Iraq could develop a shorter-range, covert, ship-launched missile threat that could threaten the United States in a very short time.”^b There are also indications that Iran test-fired a short-range surface-to-surface missile in spring 1998 from a barge in the Caspian Sea.^c

In addition, although the Rumsfeld Commission did not assess the cruise missile threat, its report noted that “...the Commission is of the view that cruise missiles have a number of characteristics which could be increasingly valuable in fulfilling the aspirations of emerging ballistic missile states.”^d The NIE further noted that short-range cruise missiles launched from a commercial ship could be used to attack the United States.

^a Rumsfeld Report, pp. 20–21.

^b Rumsfeld Report, p. 14.

^c Kenneth R. Timmerman, “Trumped by Iran’s New Missile,” *Washington Times*, 5 May 1999, p. A17.

^d Rumsfeld Report, p. 2.

Finally, the NIE considers means of delivery other than by missile (such as a ship sailed into port, manned and unmanned airplanes, and smuggling). It concludes that most of these delivery options would be less expensive, more reliable, and more accurate than ICBMs deployed by emerging missile states and that they could be covertly developed and employed. A member of the Rumsfeld Commission also noted that “The Rumsfeld Commission did not consider as a group the vulnerability of the US to BW [biological weapon] attack from ships off shore, from cars or trucks disseminating BW, from unmanned helicopter crop dusters, or from smuggled nuclear weapons or nuclear weapons detonated in a US harbor while still in a shipping container on a cargo ship; but these capabilities are more easily acquired and more reliable than are ICBMs.”^e

In addition, Robert Walpole, National Intelligence Officer for Strategic and Nuclear Programs, stated in Senate testimony:

We project that in the coming years, US territory is probably more likely to be attacked with weapons of mass destruction from non-missile delivery means (most likely from non-state entities) than by missiles, primarily because non-missile delivery means are less costly and more reliable and accurate. They can also be used without attribution.^f

^e Richard L. Garwin, “National Missile Defense,” Testimony to the Senate Foreign Relations Committee, 4 May 1999.

^f Robert D. Walpole, testimony to Senate Subcommittee on International Security, Proliferation, and Federal Services, 9 February 2000.

The Rumsfeld Report also noted that rather than developing a long-range missile, a nation might simply seek to buy one. “The Commission believes that the US needs to pay attention to the possibility that a complete, long range ballistic missile system could be transferred from one nation to another...” and that “Such missiles could be equipped with weapons of mass destruction.”²⁶ The NIE echoed this concern.

²⁶ Rumsfeld Report, p. 20.

However, while ICBMs can be used to deliver weapons of mass destruction, for a developing country that has acquired nuclear, chemical, or biological weapons, such missiles would neither be the only nor necessarily the optimum or preferred means of delivery (see box).

Warheads Available to Emerging Missile Powers. The threat that existing and potential future missiles pose to the United States depends critically on the type of warhead they carry. Missiles are not them-

selves weapons of mass destruction and, aside from the nuclear-armed missiles of the United States, Russia, China, Britain, and France, most of the world's missiles are armed with conventional explosives.

Conventional warheads. Most existing (and likely future) conventionally armed long-range missiles are not accurate enough to present a significant military threat to even soft fixed military targets (such as air bases, ports, ships stationed offshore, and troop encampments). However, conventional warheads could be fitted with a GPS (Global Positioning System) receiver to permit modest maneuvers to increase their accuracy, and such weapons should be expected in the future.

Although such inaccurate missiles are capable of striking large targets such as cities, they are not destructive enough to present a significant threat, unless used in very large numbers. For example, the 518 German V-2 missiles (each armed with roughly 750 kg of high explosives) that hit London in World War II caused, on average, slightly fewer than 5 deaths and 12 serious injuries per missile.²⁷ The Israeli casualty rates due to Iraqi missile attacks during the 1991 Gulf War were lower than the World War II rates (and even lower than would be expected once the different population densities and warhead sizes were taken into account). Iraq launched 39 missiles at Israel, although their accuracy was so poor that only one-third of these landed in populated areas. These missiles caused a total of 2 deaths and 11 serious injuries. Nevertheless, even extremely inaccurate missiles can, through chance, occasionally hit a densely occupied building and cause large numbers of deaths, as illustrated by the single Iraqi Scud that hit a US Army barracks in Dhahran, killing 28 and injuring about 100. In contrast, a single suicide bomber could expect to kill and injure dozens of people because they attack with very high accuracy. A truck bomb, which can deliver a much larger amount of explosive with high accuracy, can kill hundreds of people.

Thus, conventionally armed missiles are in no sense weapons of mass destruction. However, even if the casualty rates caused by such missiles are much lower than generally assumed, they can have a significant psychological and thus political impact if used against cities.

Chemical warheads. What if these missiles are instead armed with chemical warheads? The technology required to produce chemical agents is well within the capabilities of any country with a moderately advanced chemical or pharmaceutical industry. Producing a usable chemical weapon requires some additional steps, but it is not difficult to produce crude munitions if the chemical agents are on hand.

Indeed, Iran and North Korea are assumed to have active chemical weapons programs. Iraq used chemical weapons extensively in its war with Iraq in the 1980s. And the Rumsfeld Report notes, "Iraq also had large chemical and biological weapons programs prior to the [1991 Gulf] war and produced chemical and biological warheads for its missiles."²⁸ Indeed, many tons of chemical weapons were destroyed by Iraq under UNSCOM supervision. Now that the UN inspections have ceased, it is possible that Iraq has resumed its chemical weapons program. (Of these three countries, Iran has signed and ratified the Chemical Weapons Convention in 1997 and is therefore now subject to routine and challenge inspections.)

There are numerous ways to deliver chemical weapons. Effectiveness requires that the agent, in the form of gas or liquid spray, be released at near-ground level, as by artillery or bombs, multiple submunitions, or spray delivered by aircraft or missile. Although chemical weapons have occasionally been used in warfare, as in World War I and the Iran-Iraq war, they have never been delivered by missiles. However, both the United States and Soviet Union produced chemical warheads during the 1950s and 1960s for their short-range ballistic missiles. UN inspections of Iraq after the Gulf War also revealed that Iraq had produced some bulk agent chemical warheads for the Al-Hussein missile, although it never used them. Indeed, Iraq reserved the vast majority of its chemical weapons for delivery by artillery.

Chemical weapons delivered by even an inaccurate missile could be used to target cities. If used against a city that had no civil defense measures, 300 kilograms of sarin nerve agent delivered by a unitary missile warhead could kill hundreds or even thousands of people, assuming the agent is effectively dispersed as a vapor or volatile liquid spray at the optimal altitude and de-

²⁷ Roughly half of the missiles launched at London fell within the city limits; those that fell outside the city resulted in a much lower casualty rate.

²⁸ Rumsfeld Report, p. 14.

Delivery of Chemical and Biological Weapons by Ballistic Missile

Chemical warfare agents intended to attack the lungs may be dispersed as vapors (gases) or smokes or as volatile liquid sprays that evaporate to become vapors. The nerve agent sarin is an example of a volatile liquid agent intended to attack the lungs. Chemical warfare agents intended to attack the skin, such as the nerve agent VX, may be released as coarse drops of low-volatility liquid to deposit on skin and contaminate terrain. Agents of intermediate volatility, such as the nerve agent soman and the blister agent mustard, can attack both through the lungs and through the skin.

Most biological agents that have been considered for weapons purposes would be dispersed as an aerosol—an aerial suspension of particles so small that their settling velocity under gravity is negligible. The effectiveness of a biological aerosol depends sensitively on the size of the individual particles. The most effective particle size is in the range of approximately 1–10 microns. If too large, inhaled particles will be deposited in the upper respiratory tract, where infection is unlikely to result. If too small, the particles will simply be exhaled.

Biological aerosols may be generated either from a liquid suspension (slurry) of the bacteria, virus, or other infectious agent or from a dry powder of very small particles. Dispersal may be by explosive release or various means of spraying. In past US biological weapons programs, obtaining the desired munition characteristics, including but not limited to particle size distribution, dispersion rate, agent storage stability and dissemination survival, and infectivity have presented difficult problems of microbiology, agent formulation, and engineering. Nevertheless, by the time the United States renounced biological weapons in 1969, extensive field tests indicated that workable solutions had been found. From what is known of the Iraqi biological weapons program, it may have been still at an early stage at the end of the Gulf War, although some advanced technologies, such as fine powder production and agent encapsulation to enhance agent lifetime and dispersion characteristics were at least under study.

For biological agents in liquid suspension, an aerosol in which a substantial proportion of the particles are of the optimal size (1–5 microns) can be produced by spray tanks with specially designed nozzles or other dissemination devices mounted on airplanes, helicopters, or cruise missiles. A spray device could presumably

also be developed for use on a missile-delivered submunition. It is also possible to produce an aerosol with at least a few percent of the agent in particles within the desired size range if the agent is disseminated by explosive means. Powdered biological agents can also be disseminated by compressed gas rather than explosive. Any form of aerosol production will inactivate a certain proportion of the agent, depending on the specific conditions and agent.

The Soviet Union is said to have developed a chemical warhead for its Scud missile that used a small amount of high explosive to break open the warhead shell and then relied on wind shear to break the exposed agent into liquid droplets. This method could be effective for producing a coarse spray of a relatively nonvolatile chemical agent intended to attack the skin but would be highly inefficient for producing an effective biological aerosol.

There are other ways in which the means of delivery will affect the size of the area exposed to chemical or biological agents. The exposed area is highly sensitive to atmospheric conditions and to the altitude at which the agent is disseminated. If the release altitude is too high, the agent will be dissipated over too wide an area and, if an aerosol or vapor cloud, will be greatly diluted by vertical motions of the atmosphere. Also, for coarse sprays, release too near the ground can severely limit the area affected. The optimal release altitude will be influenced by wind speed and atmospheric stability conditions. If these are known, achieving the correct release altitude would be relatively straightforward using a low-flying aircraft, remotely piloted vehicle, or cruise missile, but more difficult using a large missile warhead that will pass through the correct altitude at a fast speed during its descent. One way to address this problem for delivery by missiles is to slow the warhead down. Prior to the Gulf War, Iraq was apparently working on a chemical warhead that would deploy a parachute to slow itself down during reentry. Because submunitions slow to subsonic speeds during descent, they are better suited to delivering these agents than large, unitary missile warheads.

Another factor is that a sprayer mounted on an airplane or cruise missile produces a line source of aerosol, which results in a large contaminated area as it drifts downwind. A unitary missile warhead, on the other hand, will produce a point source, which will result in

a smaller contaminated area along a narrow plume. For releases of several hundred to several thousand kilograms of chemical agent, the lethal area per kilogram of volatile chemical warfare agent released is two to four times greater for a line source compared with a point source. Since, in addition, the fraction of the agent delivered can be twice as great for aircraft compared with a unitary missile warhead, an aircraft could contaminate four to eight times as much area per kilogram of agent released as a unitary warhead could.^a

Artillery shells, which are fired in large volleys, produce multiple point sources that coalesce through the action of air currents and thus cover a larger area. A similar effect can be achieved for missile delivery by using submunitions, in which the agent is deployed on a large number—up to approximately 1,000—of small bomblets that are released at a high altitude or early in flight and thus scattered over a larger ground area than could be covered with a bulk-filled warhead.

Moreover, the dissemination of chemical or biological agents by submunitions delivered by ballistic missile can be tested by dropping small bomblets containing simulated agents from aircraft. In this way, tests can be done to achieve the optimal particle size.

^a The figures given in OTA, *Assessing the Risks*, pp. 53–54 to compare aircraft and missile delivery of chemical and biological agents are incorrect, apparently due to a typographical error.

The Rumsfeld Commission emphasized the possibility that a missile carrying chemical or biological agents directed against the United States might be armed with submunitions instead of a single large warhead. According to the Commission, “All of the nations whose programs we examined that are developing long-range ballistic missiles have the option to arm these, as well as their shorter range systems, with biological or chemical weapons. These weapons can take the form of bomblets as well as a single, large warhead.”^b

Thus, although missiles are generally not the most effective way to deliver chemical or biological agents, if missile delivery is desired, the most effective way to deliver these agents is by submunitions. Producing such submunitions would not be much more difficult than producing a bulk-filled missile warhead. For example, the United States developed chemical and biological submunitions for delivery by its Little John, Honest John, and Sergeant short-range missiles and by B47 and B52 aircraft in the 1950s and 1960s. China and North Korea have reportedly worked on ballistic missile warheads that would separate into 100 submunitions.^c

^b Rumsfeld Report, p. 7.

^c DFAX newsletter, *Military and Arms Transfer News*, December 1995.

pending on the population density, weather conditions, and time of day.²⁹ The number of injuries would be comparable to the number of deaths. For comparison, delivery of the same chemical agent by aerial spraying from an aircraft or cruise missile could result in ten times as many deaths and injuries. A ballistic missile equipped with many chemical submunitions would be more effective than a single warhead containing the same amount of agent, but probably less effective than aerial spraying.

²⁹ Steve Fetter, “Ballistic Missiles and Weapons of Mass Destruction,” *International Security* Vol. 16 (Summer 1991), pp. 5–42. See also US Congress, Office of Technology Assessment (OTA), *Proliferation of Weapons of Mass Destruction: Assessing the Risks*, OTA-ISC-559 (Washington, D.C.: US Government Printing Office, August 1993), p. 53; note that, apparently due to a typographical error, their figure for the approximate number of deaths corresponding to the given lethal area is too low by a factor of ten.

Thus, whether chemical weapons are “weapons of mass destruction” depends sensitively on the conditions surrounding their use. Overall, while their effects are highly variable and unpredictable, ballistic missiles armed with chemical warheads would likely be more lethal than those armed with conventional explosives, and could be much more so.

Biological warheads. In contrast to chemical weapons, biological weapons have almost never been used in modern warfare, perhaps at least in part because their effects are difficult to predict and to control.³⁰ Potential biological agents include pathogens, which are living microorganisms that can infect people, animals, or plants; and toxins, which are toxic chemicals produced by microorganisms, plants, or animals. Biological agents are easier to produce than nuclear materials;

³⁰ Japan reportedly used biological weapons (plague) against China in World War II. See OTA, *Assessing the Risks*, p. 60, footnote 23.

any country with a modestly sophisticated pharmaceutical or fermentation industry (e.g., for the production of beer or yeast) would be capable of producing biological agents. However, once the agents are on hand, it is generally more difficult to produce usable biological weapons than chemical weapons. This is in part because both pathogens and toxins are generally very sensitive to their environment and degrade quickly under many conditions.

There are methods, however, such as freeze-drying and microencapsulation, that can help stabilize and protect biological agents, and can make dissemination of the agent easier (see box for details). Most importantly, weight for weight, biological agents are hundreds to thousands of times more potent than chemical agents.³¹ In its study of proliferation technologies, the Office of Technology Assessment states that the “integration of biological agents into precise, reliable, and effective delivery systems such as missile warheads and cluster bombs poses complex engineering problems. Nevertheless, the United States had overcome these problems by the 1960s and had stockpiled biological agents.”³² Thus, despite the uncertainties surrounding their use, biological weapons are a potential threat that must be taken seriously.

Iran and North Korea are both assumed to have active biological weapons programs. According to the Rumsfeld Report, North Korea “possesses biological weapons production and dispensing technology, including the capability to deploy . . . biological warheads on missiles,”³³ and Iran is “conducting research into biological weapons.”³⁴ The UN inspections in Iraq after the end of the 1991 Gulf War revealed an extensive biological weapons program, which, according to Iraqi declarations, investigated several types of agents and produced anthrax bacteria, botulism toxin, and aflatoxin. According to the Rumsfeld Report, Iraq had produced biological warheads for its missiles.³⁵

As with chemical weapons, submunitions would be the most effective means of dispersing biological agents via ballistic missile (see box).

The anthrax bacteria is naturally relatively well-suited to delivery by missile since it forms spores that

would protect it from violent means of dispersal and temperature changes during flight and reentry. Anthrax spores are also relatively long-lived, surviving for a day or more in air; the spores can survive for decades in soil and animal hides and thus contaminate an area for long periods of time. According to its declarations to the UN inspectors, Iraq had produced 50 bombs and four Al-Hussein ballistic missile warheads armed with the anthrax bacteria.³⁶

If its accuracy was good enough to hit a city, a missile delivering 30 kilograms of anthrax spores in a unitary warhead against a city with no civil defense measures could result in lethal inhalation dosage levels over an area of roughly 5 to 25 square kilometers, assuming the agent is effectively dispersed as a fine aerosol and depending on the weather conditions and time of day.³⁷ (However, if the anthrax spores are not disseminated as a fine aerosol but as larger particles, or are disseminated at a too high altitude, the lethal area could be much smaller—see box.) With no treatment, most of the infected population would die within a week or two; for typical urban population densities this could result in the deaths of tens of thousands or even hundreds of thousands of people.

For comparison, delivery of the same amount of anthrax spores by aerial spraying from an aircraft or cruise missile could result in ten times as many deaths and injuries. Using submunitions to deliver the agent by ballistic missile would increase the effectiveness of delivery compared to a unitary warhead (see box).

Thus, it is clear that anthrax spores disseminated in a city would deserve the label “weapons of mass destruction.”

For biological weapons, as for chemical weapons, the number of warheads would probably not be limited by agent availability since these materials are readily produced in quantities large relative to the amount needed for a weapon.

Nuclear warheads. Producing (or buying) the fissile material needed for a nuclear weapon and building the weapon itself is much more difficult than building either biological or chemical weapons. Furthermore,

³¹ OTA, *Technologies Underlying Weapons of Mass Destruction*, p. 73.

³² OTA, *Technologies Underlying Weapons of Mass Destruction*, p. 9.

³³ Rumsfeld Report, p. 12.

³⁴ Rumsfeld Report, p. 13.

³⁵ Rumsfeld Report, p. 14.

³⁶ Iraqi statements also indicate that it produced 100 bombs and 5 Al-Hussein warheads armed with the botulinum toxin. However, this toxin decays rapidly upon exposure to air and has never been successfully weaponized (OTA, *Technologies Underlying Weapons of Mass Destruction*, p. 80); moreover, the Iraqis were storing these weapons at room temperature, at which the toxin also decays rapidly.

³⁷ Fetter, “Ballistic Missiles,” p. 26.

developing a nuclear warhead to put on a missile is a major technical challenge in itself. Simple nuclear weapons are generally quite large and heavy; it is a challenge to make one light enough to be carried a long distance by a missile.³⁸ Delivery by aircraft or unconventional means might be more feasible for a newly proliferant state.

Prior to the 1991 Gulf War, Iraq had an extensive nuclear weapon program, but under UN Security Council Resolution 687, its material production facilities have been destroyed. Now that UN monitoring has stopped, Iraq could reactivate its nuclear weapon program, but its efforts would have been set back substantially since it would first have to produce the required fissile material.

North Korea, which will not be in full compliance with the Nuclear Non-Proliferation Treaty (NPT) for at least several years, may have produced enough unsafeguarded plutonium for one or perhaps two nuclear weapons.³⁹ It is generally assumed that North Korea would be capable of building a simple nuclear weapon if it did have the required fissile material, but no evidence has been disclosed that it has done so.

Iran is usually presumed to be pursuing a nuclear weapon program, but there is little public evidence of progress towards this goal. Iran is a signatory to the NPT and has allowed the IAEA to make both routine and special on-site inspections, which to date have revealed no NPT compliance failures. However, it is possible that Iran is conducting nuclear weapons research at clandestine sites. In any event, Iran is likely at least

ten years away from being able to produce a nuclear weapon, unless it were able to obtain fissile material from another country.

A small nuclear weapon would kill and injure people over an area of several square kilometers. Even an inaccurate ICBM (with an accuracy of perhaps 5 kilometers) carrying a first-generation nuclear weapon (of the size of the US bomb used on Hiroshima) could kill some hundred thousand people and injure a comparable number, if detonated over a large city.

Because the fissile materials needed to build nuclear weapons are so difficult to obtain, it can be expected that the nuclear arsenals of any newly proliferant countries would be quite small. For any of these countries that managed to build or acquire one or a handful of nuclear weapons, such a weapon would be precious. For this reason, delivery by missile, which is inherently unreliable, may not be the first choice. As the Rumsfeld Report noted, a long-range missile developed by a developing country is likely to undergo only limited testing, so the reliability would be unknown. Given the complexity of a long-range missile, the owner must expect that the reliability could be quite low.

Nevertheless, an attacker may choose to use a ballistic missile. Missiles have the advantage that they are harder to defend against than are aircraft. And the attacker would presumably make defending against a nuclear-armed ballistic missile more difficult by launching such a valuable warhead with countermeasures on the missile and perhaps additional decoy missiles carrying nonnuclear payloads.

³⁸ Li Bin, "Nuclear Missile Delivery Capabilities in Emerging Nuclear States," *Science and Global Security*, Vol. 6 (1996), pp. 311–332.

³⁹ David Albright, "How Much Plutonium Does North Korea Have?" *The Bulletin of the Atomic Scientists*, Sept/Oct 1994, p. 53.

Chapter 3

The Planned NMD System

The general architecture of the planned NMD system is now fairly well established, although decisions have not yet been made about all the details. In this chapter we describe the system components, and discuss what they are designed to do and how they are designed to work together. This chapter provides an overview of the proposed NMD system; for those interested, we provide more technical details in the appendices.

Before turning to a description of the planned NMD system, we note that a missile defense system can in general be placed into one of three categories, according to where in the trajectory of the incoming missile it is designed to intercept the target. A “boost-phase” defense system is designed to intercept during the boost phase of the attacking missile, in the first few minutes after it is launched and before the missile has released its warhead or warheads. A “terminal-phase” defense is designed to intercept a missile warhead in the final stage of its trajectory, as it reenters the atmosphere shortly before reaching its target. A “mid-course” defense system covers the territory in between: it is designed to intercept a warhead after it is released by the missile but before it reenters the atmosphere, when it is traveling through the vacuum of space. For an intercontinental-range missile, mid-course is the longest part of the trajectory.

Each of these three types of missile defenses has advantages and disadvantages. However, because the technical requirements are quite different for these three types of defense systems, any one type of defense is built to operate primarily in one regime and will not generally have capabilities in the other regimes. It is of course possible to include more than one of these three types of missile defense systems in a larger, multilayered system, but the planned US NMD system consists of only one layer.

The planned US NMD system is designed to intercept incoming warheads after their release by the missile, and before reentry into the atmosphere. Thus the system would be a mid-course defense, although it might have some capability to intercept incoming objects during the early part of the terminal phase of their trajectory, when they are still very high in the atmosphere. The interceptor would be land-based, exoatmospheric (it is designed to home in on its target only above the atmosphere), and hit-to-kill (it would not use an explosive warhead to destroy an incoming warhead, but rather would need to directly hit its target to destroy it by impact).

Finally, we note that the US NMD system is intended to defend only against long-range ballistic missiles. It is neither intended nor able to counter other types of missile threats to the United States, such as cruise missiles or short-range ballistic missiles launched from ships against coastal targets.

How the NMD System Would Evolve over Time

The United States plans to build the NMD system in several stages, with the capability of the system increasing with each stage. A “preliminary” architecture released by the Ballistic Missile Defense Organization (BMDO) in March 1999 describes the NMD system as being deployed in three phases.¹ The first system configuration—dubbed the “capability-1” or “C-1” system—is designed to defend against an attack of a “few, simple” warheads. This initial system would

¹ Ballistic Missile Defense Organization, “C1/C2/C3 Architecture—Preliminary,” Briefing slide TRSR 99-082 25, 3 March 1999. This architecture is described in Michael C. Sirak, “BMDO: NMD ‘C3’ Architecture Could Feature up to Nine X-Band Radars,” *Inside Missile Defense*, 19 May 1999, pp. 13–14.

subsequently be augmented to provide a “capability-2” or “C-2” system, designed to defend against a “few, complex” warheads. The stated goal of the NMD program is to deploy a “capability-3” or “C-3” system, designed to defend against “many, complex” warheads. The term “few” refers to five or fewer warheads; correspondingly, the term “many” is unclear but refers to at least more than five warheads. The dividing line between the terms “simple” and “complex” is less well-defined (at least publicly) and more difficult to measure; these terms refer to the extent to which the attacker has incorporated countermeasures to fool or overwhelm the defense. We discuss this in much more detail in the following chapters. The planned system is designed to be compatible with further expansions, including more ground-based interceptors deployed at additional sites and space-based weapons, such as the space-based laser under research and development by the United States.

In October 1999, the administration announced that it planned to increase the number of interceptors in the initial system from 20 to 100, with other elements being the same as the C-1 plan. This system is called the “phase 1” or “C-1 prime” system. The stated intent is to defend all 50 states from a few tens of warheads with simple countermeasures from North Korea or a few warheads with simple countermeasures from the Middle East.² While the announcement in October called for deployment of the phase 1 system by 2005 or 2006, subsequent reports state that the 100 interceptors would be deployed by the end of fiscal year 2007.³ The administration said in October that the longer term goal is to deploy subsequent stages of the system, including a second interceptor site, in the 2010–2011 time frame, with the goal of defending all 50 states from a few tens of warheads with complex penetration aids launched from either North Korea or the Middle East.

The description of the three stages presented here is based on the March 1999 BMDO architecture,

updated to reflect the recent changes. However, changes to this plan, particularly to the capability-2 and capability-3 stages, are possible.

These three system configurations would differ from each other in several ways. (See Table 3-1 for the architecture of the C-1, C-2, and C-3 configurations. Figures 3-1, 3-2, and 3-3 show each system as viewed from space.) One difference is in the number of interceptors. Under the BMDO plan, the C-1 NMD system would have 20 interceptors deployed at a single site in Alaska; this number has now been increased to 100. The C-3 NMD system would increase this to 250 interceptors, with half of them deployed at a second site near Grand Forks, North Dakota.

More importantly, the number and types of sensors available to the NMD system at each capability level would also differ. The C-1 system would upgrade five existing early warning radars and deploy one new X-band radar (see the box on page 29 for a description of each component) designed specifically for NMD use at Shemya in the western Aleutians. The number of X-band radars would increase significantly as the system evolved to the C-2 and C-3 configurations, and the SBIRS-low space-based missile tracking system would first be deployed with the C-2 system.

How the NMD System Is Designed to Operate

To intercept and destroy an incoming ballistic missile warhead, the US NMD system must successfully perform a series of tasks. First, it must detect the launch of the ballistic missile and determine the general direction that the missile is going. Once the booster is done burning, the NMD system must detect the warhead(s) and any other objects accompanying them (such as missile debris or decoys), then begin to track these objects and predict their future trajectories. At some point in this process, the NMD system must discriminate the actual warhead(s) from the other objects and track the warhead(s) with sufficient accuracy to determine a predicted intercept point. If the system cannot discriminate the warhead(s) from other objects, it must instead track all the possible targets. The defense must then launch one or more interceptors towards the predicted intercept point for each target (or, if several potential targets are close together, for each cluster of targets). As the interceptor flies out, the defense must continue to track each target and send updated trajectory information to the interceptor. Once the interceptor is within a certain distance of its assigned target, it must release the kill vehicle. The kill vehicle must then detect the objects with its own sensors and, if necessary,

² The recent administration changes are described in the testimony of Lt. Gen. Ronald T. Kadish, Director, Ballistic Missile Defense Organization, to the Strategic Forces Subcommittee of the Senate Armed Services Committee, 28 February 2000, and in the testimony of Walter B. Slocombe, Undersecretary of Defense for Policy, to the House Armed Services Committee, 13 October 1999. See also Michael C. Sirak, “Administration Seeks Phased NMD Fielding, Phased ABM Treaty Changes,” *Inside Missile Defense*, 20 October 1999, pp. 1, 33, 34.

³ Daniel Dupont, “More Tests, Interceptors Funded in New National Missile Defense Plan,” *Inside Missile Defense*, 29 December 1999, pp. 14–15.

Table 3-1. Preliminary Architecture for the C-1, C-2, and C-3 NMD systems.

In the case depicted below, the first interceptor site is in Alaska, with a second site in North Dakota added for the C-3 configuration.

	C-1 Configuration	C-2 Configuration	C-3 Configuration
Number of Interceptors Deployed in Alaska	100	100	125
Number of Interceptors Deployed in North Dakota	0	0	125
Upgraded Early Warning Radars	Beale (Marysville, Calif.) Clear (Alaska) Cape Cod (Mass.) Fylingdales (England) Thule (Greenland)	Beale Clear Cape Cod Fylingdales Thule	Beale Clear Cape Cod Fylingdales Thule South Korea
X-band Radars	Shemya (Alaska)	Shemya (Alaska) Clear (Alaska) Fylingdales (England) Thule (Greenland)	Shemya Clear Fylingdales Thule Beale Cape Cod Grand Forks (N. Dakota) Hawaii South Korea
In-Flight Interceptor Communications Systems	Central Alaska Caribou (Maine) Shemya (Alaska)	Central Alaska Caribou Shemya Munising (Mich.)	Central Alaska Caribou Shemya Munising Hawaii
DSP or SBIRS-high?	Yes	Yes	Yes
SBIRS-low?	No	Yes	Yes

Sources: Ballistic Missile Defense Organization, "C1/C2/C3 Architecture—Preliminary," Briefing slide TRSR 99-082 25, 3 March 1999; Michael C. Sirak, "BMDO: NMD 'C3' Architecture Could Feature up to Nine X-Band Radars," Inside Missile Defense, 19 May 1999, pp. 13–14. Note that the March 1999 plans for the C1 system included only 20 interceptors in Alaska; this table lists the number of interceptors in the C1 system as 100 because the Clinton administration has increased the number of interceptors in the initial deployment to 100.

discriminate the warhead from the other objects. Finally, the kill vehicle must home on the warhead and maneuver to hit it directly.

We discuss each of these tasks in somewhat more detail below and describe the NMD components that would perform the various tasks (see the box on page 29 for a description of each component). We relegate a more detailed discussion of the technical

parameters and capabilities of these components to Appendices B and D.

Launch Detection. The United States currently operates a system of early warning satellites in geosynchronous orbit that use infrared sensors to detect the hot plume of a missile booster in the early stage of its flight. These satellites, known as DSP (Defense

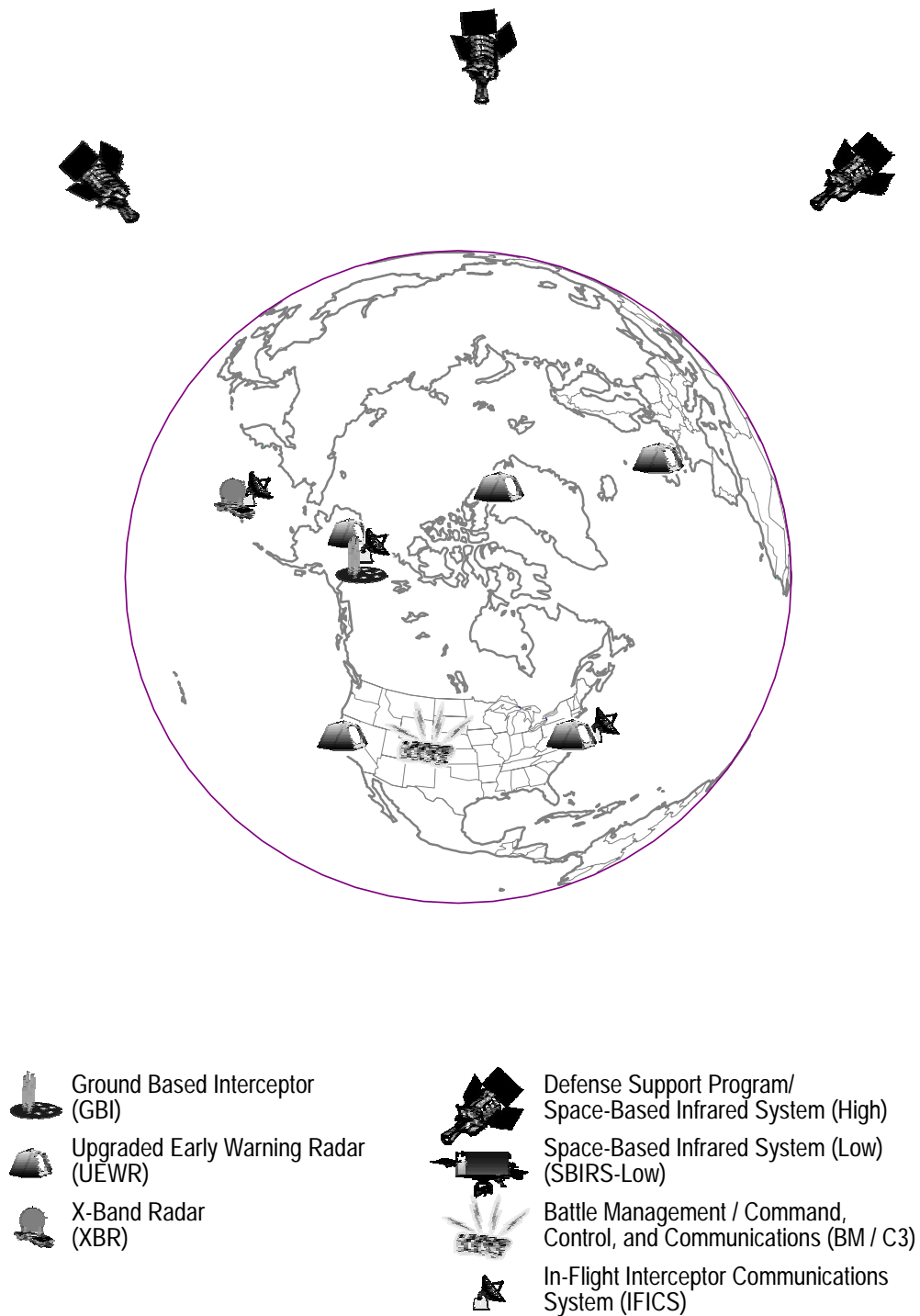

Figure 3-1. View from space of C-1 National Missile Defense system.
 The DSP/SBIRS-high system consists of 5-6 satellites.

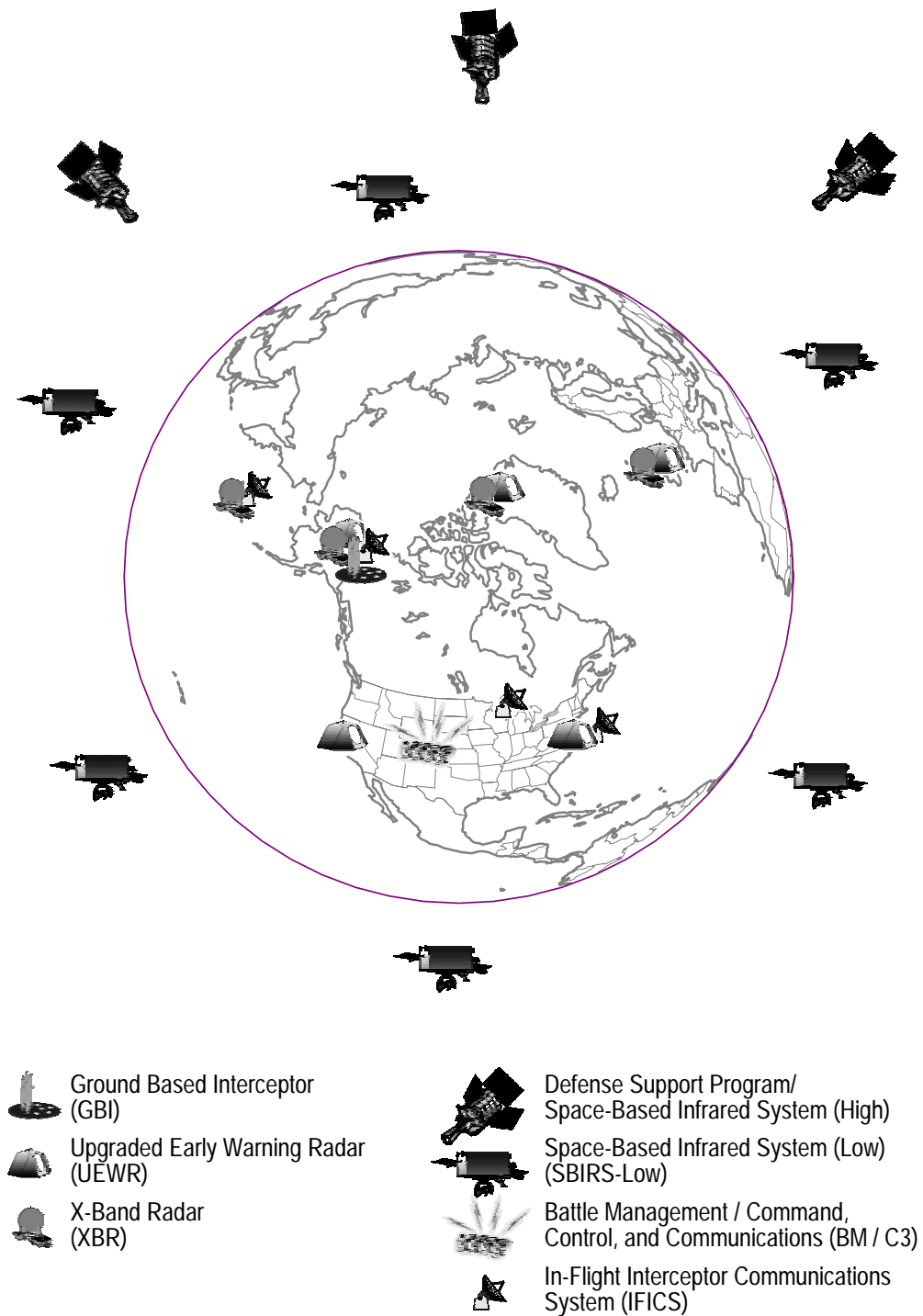

Figure 3-2. View from space of C-2 National Missile Defense system.
 The DSP/SBIRS-high system consists of 5-6 satellites, and approximately 24 SBIRS-low satellites are planned.

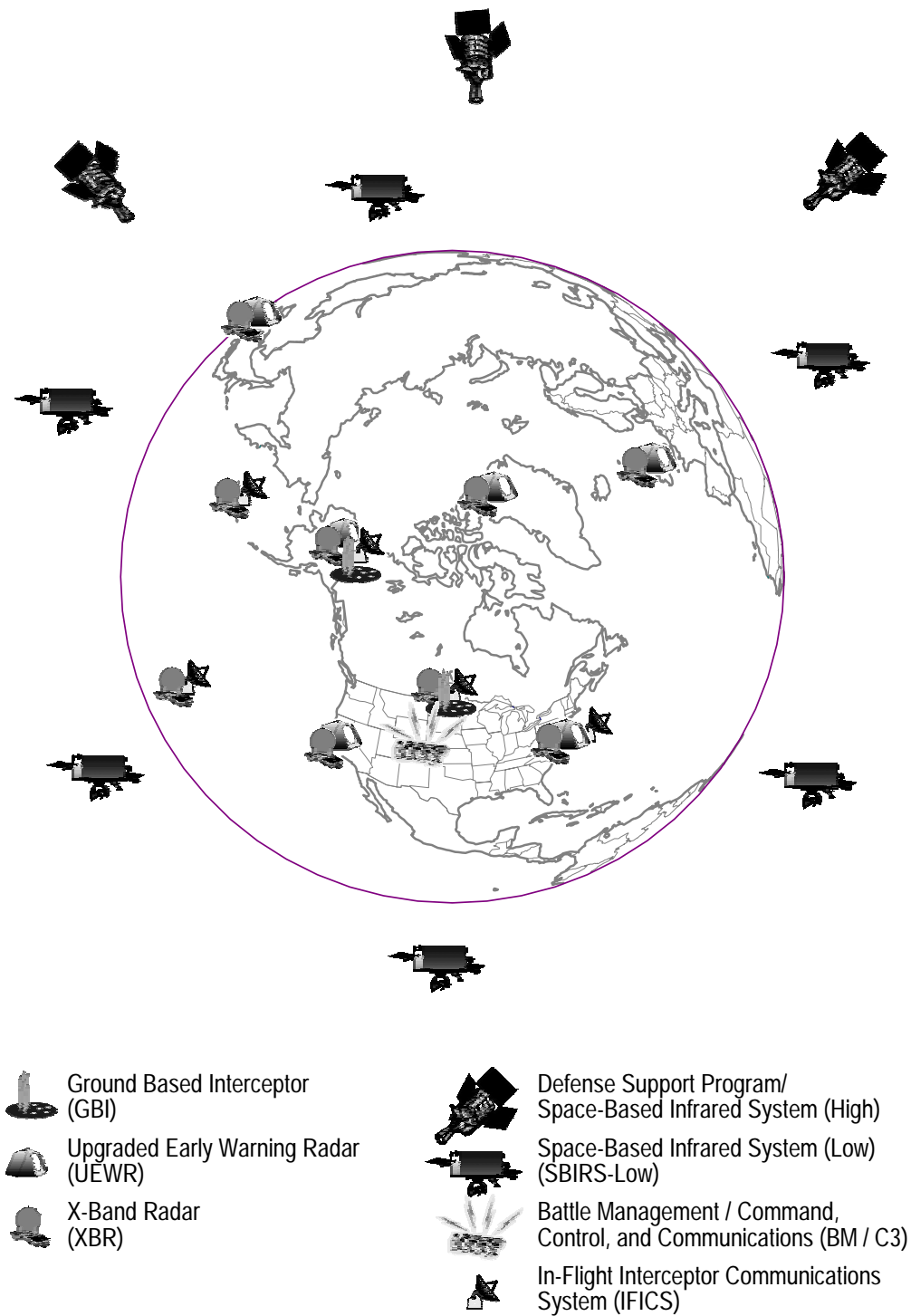

Figure 3-3. View from space of C-3 National Missile Defense system. The DSP/SBIRS-high system consists of 5-6 satellites, and approximately 24 SBIRS-low satellites are planned.

NMD Components

Early Warning Satellites (DSP/SBIRS-high)

US early warning satellites are designed to detect the launch of a ballistic missile, and to provide a rough location of the missile launch and limited information about the trajectory of the missile. The current early warning satellites, known as Defense Support Program or DSP satellites, will in the next decade be supplemented and eventually replaced by 5 or 6 new early warning satellites. These new satellites are referred to as the high Earth orbit component of the Space-Based Infrared System, or SBIRS-high. All these early warning satellites use infrared sensors to detect the hot plume of the missile during its boost phase. After the missile has stopped burning and the warhead(s) are released, the satellites can no longer see the missile or its warheads.

Ground-Based Interceptor (GBI)

The NMD interceptor will consist of an exoatmospheric kill vehicle (EKV) on top of a booster. The booster will be a three-stage missile based in an underground silo. It will boost the kill vehicle to a speed of 7–8 kilometers per second before releasing the kill vehicle. The kill vehicle will be capable of intercepting a target outside the Earth's atmosphere. It will first use infrared and visible-light seekers to home on its target, with the final homing performed by the infrared seekers. The kill vehicle is "hit-to-kill," meaning that it will destroy its target by direct impact with it. The kill vehicle can maneuver in a lateral direction using small side thrusters. A kill vehicle designed by Raytheon Corporation has been selected for the NMD system, while one designed by Boeing will serve as a backup.

Upgraded Early Warning Radars (UEWRs)

The United States deploys early warning radars at several locations worldwide; these radars are designed to track incoming missiles and warheads in flight after the early warning satellites can no longer do so. The current early warning radars consist of three BMEWS (Ballistic Missile Early Warning Radars) in Alaska, Greenland, and Britain, and two Pave Paws radars in California and Massachusetts. These radars are currently not able to track targets with high enough accuracy to guide interceptors, but would be upgraded to give them this capability.

X-Band Radars

The NMD system will use phased-array, X-band radars specifically designed for use in the NMD

systems. ("X-band" refers to the frequency of the radar waves produced; in this case the frequency is 10 gigahertz.) These radars will have a better tracking capability than the early warning radars, and they are also designed to help distinguish the warheads from debris and false targets. The first X-band radar would be deployed at Shemya in the Aleutians, with subsequent radars deployed alongside the upgraded early warning radars, at interceptor sites, and elsewhere. A prototype is now in operation at the Kwajalein missile test range.

Space-Based Missile Tracking System

The United States is also developing a system of satellites designed to accurately track missiles in flight. The system is currently referred to as the low Earth orbit component of the Space-Based Infrared System, or SBIRS-low; it was previously known as the Space and Missile Tracking System (SMTS) and before that as "Brilliant Eyes." The full constellation will have approximately 24 satellites, each of which will have several types of sensors. These include a short-wavelength infrared sensor with a wide field of view, designed to detect (or "acquire") the missile during its boost phase; and medium- and long-wavelength infrared and visible light sensors with narrow fields of view, designed to track a target once it is detected. The track data is intended to be accurate enough to guide interceptors without assistance from other sensors. In addition, SBIRS-low is designed to help with target discrimination. Two different "proof of concept" satellites were scheduled to be launched at the end of 1999 or in early 2000, but in February 1999, the Air Force cancelled its contracts with Boeing and TRW, citing cost overruns and technical problems. Initial deployment is still scheduled for 2006, but this date is likely to slip.

Battle Management Center

All the data from the various space- and ground-based sensors will be integrated at the main NMD battle management center, to be located at Cheyenne Mountain in Colorado.

In-Flight Interceptor Communications Systems (IFICS)

The NMD system will use several ground stations to relay communications from the battle management center to interceptors that have flown over the horizon.

Support Program) satellites, are able to detect the launch of any ballistic missile worldwide⁴ and provide the rough location of its launch point and rough information about its trajectory.

Beginning in 2004, the DSP satellites will be replaced by a new system of early warning satellites known as SBIRS-high (Space-Based Infrared System—high Earth orbit), which will also use infrared sensors to detect missile plumes but will have improved capabilities.

The data from the early warning satellites would be fed to the NMD battle management center, to be located at Cheyenne Mountain in Colorado. Based on the length of time the booster burns, the launch location, and the rough trajectory information provided by the early warning satellites, the battle management center would determine whether the missile poses a possible threat to US territory and whether the NMD system might have to try to intercept it.

Warhead Detection and Tracking. Once the missile booster has stopped burning, it would no longer be visible to the early warning satellites. Using the information these satellites provide about the boost phase of the missile, other NMD sensors must then take over and detect and track the warhead(s) as well as any missile debris, decoys or other objects produced by the missile. By tracking an object over a period of time, the NMD system would estimate its trajectory with increasing accuracy and determine the point in space to which the interceptor should deliver the kill vehicle, which would then home on the object and try to hit it.

The sensors that the NMD system would use to track the warhead(s) include the existing early warning radars; new X-band ground-based phased-array radars; and a satellite-based tracking system that would use infrared and visible light sensors.

Because the United States is geographically large and the Earth is curved, a ground-based radar at any one site could not detect and track all long-range missiles that could detonate in the United States. For example, a radar based in North Dakota could not detect missiles launched from North Korea that would detonate in Hawaii, whereas a radar based in Alaska could not detect missiles fired on trajectories over the Atlantic that would detonate on the East Coast.⁵ Moreover,

if the NMD interceptors are based at only one or two sites, but must cover the entire United States, they would need to fly far from their deployment site to intercept their targets. Thus, it would be important to track incoming objects as early as possible so that the interceptors can be launched as early as possible, particularly if the system is to observe the results of one or more intercept attempts before launching more interceptors. Therefore, in addition to any radars deployed at interceptor sites, the NMD system requires a number of forward-deployed radars to track incoming targets and to guide the interceptor toward them.

The United States currently operates five early warning radars, located in California, Massachusetts, Alaska, Greenland, and Britain. These radars are designed to provide warning of a nuclear attack and to permit the launch of US nuclear weapons before the incoming warheads land. Currently they are not able to track targets accurately enough to provide information adequate to guide interceptors. Under the Upgraded Early Warning Radar program, the United States is developing software and hardware modifications to increase the radars' tracking capability to give them this capability.

Using data from the early warning satellites that provides the approximate launch point and a rough trajectory of the incoming missile, the upgraded early warning radars would search the appropriate area of sky to detect the targets. The more accurate the information about the target trajectory that is provided to the radar, the smaller the area of sky the radar must search, and the further away it can detect the incoming targets. However, even following these upgrades, the early warning radars will have only very limited capabilities to discriminate warheads from decoys or other false targets.

Thus, the NMD system will also deploy a number of new X-band radars⁶ that are specifically designed for NMD use and which will have much better range resolution, and discrimination and tracking capabilities than the early warning radars. The first X-band radar will be deployed at Shemya, at the western end of the Aleutian Island chain, where it will be well positioned to observe missiles launched from North Korea. Subsequent X-band radars will be deployed

⁴ The DSP system might not be able to detect the launch of a very short-range ballistic missile, but that is not relevant to the NMD system, which is designed to intercept long-range ballistic missiles.

⁵ Radar coverage is discussed in Lisbeth Gronlund and David Wright, "Limits on the Coverage of a Treaty-

Compliant ABM System," *Physics and Society*, Vol. 22, no. 2, April 1992, pp. 3–6.

⁶ X-band refers to the frequency of the radar waves that the radar uses. The X-band lies between 8 and 12 gigahertz (GHz); the corresponding wavelength is approximately 3 centimeters.

alongside the early warning radars, at interceptor sites, and elsewhere.

The United States also plans to deploy a satellite-based missile tracking system. Originally an SDI program called the Space Surveillance and Tracking System (SSTS), this program evolved into the Brilliant Eyes program, which was first renamed the Space and Missile Tracking System (SMTS) and then more recently the Space-Based Infrared System—low Earth orbit (SBIRS-low). SBIRS-low is the sensor that would provide the earliest tracking capability following a missile launch as well as worldwide coverage, but it is also the least developed and the furthest from deployment. It is an Air Force program intended for use by both national and theater missile defenses. The full system would have approximately 24 satellites equipped with both wide field of view infrared sensors designed to detect targets during boost phase (acquisition sensors) and narrow field of view infrared and visible light sensors designed to track targets during midcourse (tracking sensors). This satellite system is designed to provide track data accurate enough to guide interceptors, if necessary without assistance from other sensors. In February 1999, the Air Force cancelled its SBIRS-low contracts with Boeing and TRW, citing cost overruns and technical problems. Initial deployment is still scheduled for 2006, but this date is likely to slip.

The track data from the ground-based radars and space-based sensors would be routed to the NMD battle management center. The center's computers would then estimate the trajectory of each object being tracked and predict the future position of the object as a function of time.

Warhead Discrimination. If the missile deploys more than one object, then once the NMD system has detected the objects, it must determine which of these are warheads and which are not. Otherwise, the NMD system—with a limited number of interceptors—would risk simply running out of interceptors.

While the warheads and decoys are traveling through the vacuum of space—where there is no air resistance—the lighter decoys and heavier warheads would all travel at the same speed. If the objects are roughly the same size, when they begin to reenter the atmosphere, the lighter decoys would slow down relative to the heavier warheads, allowing the warheads to be identified by the X-band radars because they can measure small changes in velocity. (The altitude at which a decoy will slow down relative to a warhead depends on the weight, size, and shape of the decoy.) Once the decoys slow down enough, the NMD system

would be able to determine which objects are the warheads. However, the kill vehicle has a minimum intercept altitude, below which it cannot intercept a target. Because the kill vehicle uses an infrared sensor to detect and home on the target, it would be blinded by the heating that would occur as the sensor flies through the atmosphere. Moreover, the kill vehicle will have an airframe that is not aerodynamic and would thus become unstable in the atmosphere where it would experience lift and drag forces. If this minimum intercept altitude is comparable to the altitude at which the radars can first discriminate the lightweight decoys from a heavier warhead, the NMD interceptor may not be able to fly low enough to even make an intercept attempt.

The NMD system would thus need to discriminate the warheads from the decoys before these objects reenter the atmosphere. The ground-based X-band radars can make very detailed measurements of the motions of an incoming object (such as whether it is wobbling or rotating) as well as some of its physical characteristics, including its length (projected along the direction between the target and radar), certain structural details, its velocity, and its radar cross section. The radar cross section of an object is a measure of the apparent size of the object as seen by the radar and depends on the physical size of the object, on how well its surface reflects or absorbs radar waves, and on the shape of the object (see Appendix C). In some circumstances, the X-band radars may be able to produce a two- or even three-dimensional image of a target (see Appendix D).

SBIRS-low is specifically designed to help with target discrimination by adding different types of sensors to the NMD system. When SBIRS-low becomes available, the NMD system could also attempt to discriminate decoys from warheads by using infrared sensors, which detect the heat radiated by an object. Thus, if it were known that a warhead was hotter (or cooler) than the decoys, the infrared sensor should be able to distinguish one from the other. In addition, SBIRS-low will have a sensor in the visible spectrum that detects reflected sunlight and may provide other types of information about incoming objects in a daytime attack.

The NMD battle management center would integrate the information from these various sensors and decide which objects the system should try to intercept.

Finally, if the decoys and warheads were spaced closely enough together, the infrared and visible sensors on the kill vehicle itself could be used to attempt to discriminate the warheads from the decoys. This strategy could be implemented only if the objects were

spaced closely enough that the kill vehicle would have time to maneuver and reach any of these objects once it determined which one was the warhead. When the kill vehicle first acquired the target, which could occur at ranges as great as one thousand kilometers or more, its infrared sensors would provide data similar to that from SBIRS-low. This would permit the NMD system to determine the temperature of an object and the intensity of the infrared radiation emitted by it. However, as the kill vehicle drew closer to the target, its spatial resolution would improve and it would increasingly be able to image the target and other objects close to it. These images could also potentially be used to discriminate the warhead from the other objects. In addition, the first kill vehicle could send such images of closely spaced objects to the NMD system to help subsequent kill vehicles discriminate the warhead from decoys and other objects. This strategy would rely on firing multiple interceptors against each potential warhead.

Interceptor Guidance. Once the NMD system has decided which object to intercept, it would launch one or more interceptors towards the predicted intercept points. The NMD interceptor would consist of a three-stage missile booster and an exoatmospheric kill vehicle (EKV), which would separate from the booster once it has burnt out. The booster would accelerate the kill vehicle to a speed of 7–8 kilometers per second. Once the kill vehicle was above the atmosphere, it could maneuver by using small thrusters to divert it in a chosen lateral direction.

In order to increase the probability of a successful intercept, the NMD system would likely fire multiple interceptors per target.⁷ If time permits, the NMD system would likely use a “shoot-look-shoot” tactic whereby it would fire additional interceptors at a target only if the previous ones failed to hit it. However, this tactic may be possible only if the incoming warhead’s trajectory takes it close enough to the interceptor launch point. Otherwise the fly-out time for the second interceptor could be too long to permit a second launch to be delayed until it was certain that the first interceptor had failed. In this case, the NMD system would have to use the less efficient strategy of firing several

interceptors at once or in quick succession (known as a salvo launch).

Once an interceptor has been launched at a specific target, the NMD system would continue to track the target and the interceptor in order to update the predicted intercept point. The job of the NMD system would then be to guide the booster and the kill vehicle to the point in space where the kill vehicle should be able to detect the target using its own sensors (known as the acquisition point). From that point the kill vehicle should be able to home on and hit the target. The acquisition point would be calculated by the NMD system based on the estimated trajectory of the target.

The NMD system would use an In-Flight Interceptor Communications Systems (IFICS) to relay communications from the battle management center to interceptors that have flown over the horizon. The IFICS would consist of several ground stations deployed at forward locations.

Kill Vehicle Homing. The kill vehicles are designed to destroy their targets by colliding with them at high speeds. Once the kill vehicle is close enough to its target, its on-board infrared and visible sensors would be used to detect the target and home on it. In order for this to be possible, the target must be in the searchable field of view of the sensors when the kill vehicle reaches the acquisition point. The region of space that is within the kill vehicle’s field of view and within which the kill vehicle can maneuver to make an intercept is referred to as the interceptor “basket.”

During the homing process, the kill vehicle would continue to receive information on the target, based on data from the radars and SBIRS-low satellites, which could assist in discrimination.

The kill vehicle would use small thrusters to maneuver. As noted above, the kill vehicle has a minimum intercept altitude, below which it cannot intercept a target. The Ballistic Missile Defense Organization is trying to achieve a minimum intercept altitude of 130 kilometers.⁸

Battle Management. As mentioned above, once a ballistic missile is launched, data from the early warning satellites would be fed to the NMD battle management center where computers would determine whether the missile might need to be engaged by the NMD system. Of course, more than one missile might be launched at a time or in quick succession.

⁷ For example, the fact that an initial 20 interceptor deployment is said to be able to deal with about five warheads indicates that it is expected that it may be necessary to fire as many as four interceptors per warhead to get the required system kill probability. See also Michael Dornheim, “Missile Defense Design Juggles Complex Factors,” *Aviation Week and Space Technology*, 24 February 1997, p. 54.

⁸ Lt. Col. Rick Lehner, NMD Joint Program Office, personal communication, January 2000.

The track data from the ground-based radars and space-based sensors would also be routed to the NMD battle management center. The center's computers would then estimate the trajectory of each object being tracked and predict the future position of the object as a function of time. In order to develop trajectory information for multiple objects that are similar in appearance and are close to each other, the system would need to consider all the possible trajectories that could be consistent with successive position measurements.

In addition, the battle management center would need to integrate all the sensor data to determine which objects are potential warheads. Finally, the center would need to make kill assessments, to determine which warheads the NMD system had failed to intercept. This would be essential to implement a "shoot-look-shoot" strategy.

Chapter 4

Countermeasures to the Planned NMD System: Why the Attacker Has the Advantage

In this chapter we examine the general requirements for an effective limited national missile defense against nuclear and biological weapons, and for effective offensive countermeasures to a limited NMD. We also note the specific characteristics of the planned NMD system that would make it more difficult for the system to meet the requirements for an effective defense.

It is a truism that the development or deployment of a weapons system often leads to the development and deployment of another system to counter the first. Indeed, the planned US national missile defense is itself such a response to ballistic missiles. Thus, one must expect that countries that want to acquire or maintain the ability to attack the United States with intercontinental-range ballistic missiles will respond to the deployment of a US NMD system by incorporating countermeasure strategies and technologies to defeat it.

While the outcome of a competition between offensive and defensive weapons systems will in general depend on many factors and technical details, it is nonetheless possible to say something about the relative difficulty of the offensive and defensive missions in the case of interest here.

It might seem that the United States—with its far superior technology and bigger defense budget—should be able to build a national missile defense that could overcome any countermeasures an attacking state—especially an emerging missile state—could use. However, there are many operational and technical reasons why it is much more difficult to build an effective NMD system than to build an effective offense. These inherent advantages can enable an attacker to compensate for US technical superiority.

Defense Will Commit First

The attacker has a strong advantage because the defense must commit to a specific technology and architecture before the attacker does. As is happening now with the US NMD program, the defense will choose and then deploy hardware whose general characteristics will be known to the attacker. Moreover, because it will take at least several years to build an NMD system, the attacker will have adequate time to respond.¹ The attacker need not commit to a countermeasure technology until after the defense system is being deployed, and it can then tailor its countermeasures to the specific system that the defense builds.

The defense might be able to learn something about a potential attacker's countermeasure program if its countermeasures are flight-tested and the defense can observe the tests. However, even if the defense could obtain some information about a particular countermeasure in this way, it could not know the details of how such countermeasures would actually be implemented or what other countermeasures the attacker intended to use. Moreover, since the other country would know that its flight tests would be monitored, it might choose to conduct tests that were deliberately misleading, and the defense could not rule out this possibility.

Because the defense will not know with certainty what countermeasures the attacker would use, it must

¹ In fact, the long time required to build the large phased-array radars used for ballistic missile defenses motivated many of the restrictions in the Anti-Ballistic Missile (ABM) Treaty that are intended to give each country adequate time to respond to a withdrawal from or violation of the treaty by the other country. For a full discussion, see Lisbeth Gronlund and George Lewis, "How a Limited National Missile Defense Would Impact the ABM Treaty," *Arms Control Today*, November 1999, pp. 7–13.

be prepared for all plausible ones. And while the defense can attempt to anticipate and prepare for a range of offensive countermeasures, it cannot anticipate every possible countermeasure or combination of countermeasures. Moreover, the defense cannot anticipate exactly how an attacker will choose to design and implement the countermeasures it employs.

In many cases, even if the defense knew in detail what countermeasure the attacker intended to use, the defense would still not be able to defeat the countermeasure. (For example, even if the United States knew that an attacker planned to use biological weapons deployed on submunitions, the planned NMD system could not defend against such an attack.) Indeed, not all US countermeasures developed in the 1960s were classified top secret. Instead, some of these countermeasures were considered to be “spy-proof”—meaning that even if the Soviet Union had been able to learn everything about them, it could not have done anything to keep the countermeasures from defeating the defense.

Defense Must Work First Time

The defense would have essentially no opportunity to modify its tactics or hardware to take into account the countermeasures used by the attacker, should an actual attack occur. An attack on the United States by long-range ballistic missiles armed with weapons of mass destruction would be a rare event. Such an attack almost certainly would not occur over an extended period of time, but would be confined to a few hours or at most a few days.

Since any intercontinental-range missiles deployed by emerging missile states will be large and their launchers vulnerable to attack, the attacker would carry out its attack over a short period of time in anticipation of a US effort to destroy any remaining missiles. Thus, a situation such as occurred in the 1991 Gulf War—in which Iraqi missile attacks from mobile launchers continued for more than a month and the United States had time to modify its Patriot missile defense—would be highly unlikely for an attack by an emerging missile state on the United States. As a result, the defense would have little or no time to learn how to deal with an attacker’s countermeasures. Yet, if an NMD system is to be effective, it must be able to defeat countermeasures the first time it encounters them.

Defense More Technically Demanding

The job of the defense is technically more complex and thus difficult than that of the offense. Any defense must be “active”: it must respond to its external

environment, which will vary with the attacker, and make decisions and take actions based on its sensor measurements. In contrast, the offense can be essentially passive: it can simply carry out a set of preplanned actions independent of what the defense does.

In addition, the defense has more demanding requirements on accuracy than does the offense. The hit-to-kill interceptors must arrive at a precise point in space at precisely the right time whereas the offensive warhead only need target a relatively large area on the surface of the earth. (In contrast, the US defense system deployed in 1975 used nuclear-tipped interceptors, which only needed to explode within a few kilometers of the incoming warhead to destroy it.) The target will be only a few meters long and will be moving at a very high speed relative to the kill vehicle (roughly 10 kilometers per second). This demanding feat has been described as “hitting a bullet with a bullet.” Even more relevant than the inherent difficulty of hit-to-kill technology is that the low margin of error makes it easier for an attacker to foil the defense. Thus, countermeasures that an attacker takes can make this very difficult job essentially impossible.

Moreover, the attacker gets to choose the timing of the attack and can target the attack in a way that is most stressing to the defense. The time constraints add to the technical difficulty: the defense has only a very short time—well under 30 minutes—to respond. And the confusion that would almost certainly accompany an actual attack would complicate the job of the defense.

Standards of Success for Defense Are Higher

National missile defenses are intended to defend against missiles armed with weapons of great destructive power: nuclear and biological weapons. This mission places a very high requirement on defense effectiveness—much higher than the requirement on offense effectiveness.² Any failure of the defense would lead to large numbers of deaths, whereas an offense that partially failed could still succeed in its mission. For

² Two of the three main missions supporters of NMD claim for it, preserving US freedom of action and deterring development and deployment of ICBMs, require that the defense be highly effective. The third mission, damage limitation, does not absolutely require high effectiveness (although this would clearly be desirable), but any benefits this mission can provide are likely to be more than outweighed by the negative consequences of deploying an NMD system. See George Lewis, Lisbeth Gronlund, and David Wright, “National Missile Defense: An Indefensible System,” *Foreign Policy*, Issue 117, Winter 1999–2000, pp. 120–137.

example, a defense that intercepted 25 percent of the incoming warheads would be much less successful than an attack in which 25 percent of the warheads hit their targets.

Not only must the defense be effective to be useful, but in most cases the defense must also know with a high level of confidence how effective the system is.³ Effectiveness and confidence level are two very different things, but both are needed to describe a system. Effectiveness is a property of the system, and testing is used to determine what the effectiveness is. Confidence level describes how well the system effectiveness is known as a result of testing. (See box on Confidence and Effectiveness in Chapter 10 for more details.) Even if a defense system were in fact highly effective, without adequate testing the country deploying it would have no way of knowing what the system effectiveness was.

Indeed, consistent with its mission of intercepting nuclear warheads, the NMD system reportedly has a

design requirement of 95 percent effectiveness with 95 percent confidence against a small-scale missile attack.⁴ Yet an effectiveness of 95 percent is rarely—if ever—achieved by a complex military weapons system that faces countermeasures, even after years of use. Moreover, high confidence in the effectiveness of any national defense system will be difficult to obtain. If the tests do not adequately approximate the (unknown) conditions under which the system would operate, then even a large number of successful tests will provide little meaningful information about the system's operational effectiveness.

To summarize: the defense faces the extremely difficult task of assessing and responding to an attack that is explicitly designed to defeat it. The attack may have characteristics quite different from anything that has been anticipated or that the defense has been tested against. And the defense will have to respond quickly and successfully the first time it is tried.

³ Lewis, Gronlund, and Wright, "National Missile Defense: An Indefensible System," p. 128.

⁴ Michael Dornheim, "Missile Defense Design Juggles Complex Factors," *Aviation Week and Space Technology*, 24 February 1997, p. 54.

Chapter 5

Countermeasure Programs in the United States, Britain, France, Russia, and China

The development of countermeasures is not just a theoretical possibility, but rather something that every country possessing intercontinental-range ballistic missiles (ICBMs) or submarine-launched ballistic missiles (SLBMs) has already undertaken, despite the fact that only very limited deployments of ballistic missile defenses have actually taken place. Indeed, it is generally assumed that both Russia and China have the technical and financial capability to deploy effective countermeasures and that these countries would do so in response to the deployment of the planned US NMD system, if they were concerned about the ability of the defense to degrade their deterrent. More details on the US, French, and British programs are given in Appendix E.

Below we briefly describe what is publicly known about the past and current countermeasure programs of the only countries that have deployed ICBMs and SLBMs: the United States, France, Britain, the Soviet Union (and now Russia), and China.

Of course, of these countries, the US NMD system would only face Russian and Chinese countermeasures. However, more information is available about past US, British, and French countermeasure programs, and these programs also give some indication of what countermeasures Russia and China might deploy in response to a US NMD deployment. These programs demonstrate that countries have responded to even the possibility of defense deployments by developing, producing, and in some cases deploying a variety of offensive countermeasures.

Past and Current Countermeasure Programs to Ballistic Missile Defenses

United States. The current configuration of the US nuclear arsenal—with its missiles that carry anywhere from three to ten warheads each—is at least in

part a consequence of the US decision in the 1960s to respond to a possible Soviet ballistic missile defense. The United States developed and deployed MIRVs (multiple independently-targeted reentry vehicles) to greatly increase the number of warheads it could deliver and therefore overwhelm the defense. In addition, the United States has engaged in research and development of many other types of countermeasures.

Countermeasures for ICBMs. Although most information about missile defense countermeasures remains classified, it is clear that US work on countermeasures dates back to the early stages of ICBM development. By early 1964, the United States was reportedly spending \$300–400 million (equivalent to \$1.8–2.4 billion in 1999 dollars) annually in research, development, and production of countermeasures,¹ and a wide variety of technologies were being investigated (see Appendix E). These efforts focused on defeating missile defenses that used two types of nuclear-armed interceptors capable of intercepting warheads both above and within the atmosphere, because those were the type of missile defense systems that the United States and Soviet Union were developing at that time. These nuclear-armed interceptors only needed to detonate within several kilometers of a warhead to destroy it. Since penetrating such a two-layer nuclear-armed defense is more difficult than penetrating a single-layer defense using hit-to-kill interceptors, in many respects these early countermeasures had a more difficult task than would countermeasures to the current NMD system.

Countermeasure work was not just limited to research and development: the United States produced

¹ "Penetration Aids: A Space/Aeronautics Staff Report," *Space/Aeronautics*, February 1964, p. 47.

decoys for deployment on its first-generation liquid-fueled ICBMs: the Atlas F and Titan 2 ICBMs. The Air Force also stated that its Minuteman ICBMs would carry countermeasures (most likely decoys).²

Reportedly, all current US ICBMs are capable of using countermeasures.³

Countermeasures for SLBMs. The United States also developed and produced a countermeasure system that included decoys, chaff, and electronic countermeasures for its Polaris A-2 SLBM in the early 1960s. The systems were deployed on the SLBMs of one submarine, but were removed when the anticipated Soviet missile defenses did not appear. The United States developed and produced a new countermeasure package for the follow-on Polaris A-3 SLBM. It then developed and produced a second package specifically designed to defeat the ballistic missile defense then under construction around Moscow. Ultimately none of the Polaris A-3 countermeasures were deployed, in part because it became apparent that the Moscow ABM system would remain limited in scale (and the task of defeating it was assigned to the Minuteman ICBMs and their countermeasures) and because the US Navy decided to emphasize the development of its next SLBM, the Poseidon.

The Poseidon SLBM, first deployed in 1971, was capable of carrying up to 14 independently targeted reentry vehicles and was thus considered inherently resistant to missile defenses such as those deployed around Moscow. Nevertheless, the United States studied various additional countermeasure concepts for Poseidon. However, with the signing of the 1972 Anti-Ballistic Missile (ABM) Treaty and its 1974 protocol, the Soviet Union was limited to deploying only 100 interceptors around Moscow. Since it became clear the Soviet ABM threat would remain limited, the United States apparently did not deploy any of these additional Poseidon countermeasures.

The United States also developed a countermeasure system for the successor to Poseidon: the Trident I SLBM. After a development program that included a number of test flights, the countermeasure program was put on a maintenance status, which provided the

ability to deploy within three years of a decision to do so. Work on countermeasures for the currently deployed Trident II SLBM is known to have taken place.

France. France has deployed two types of long-range ballistic missiles: land-based intermediate-range ballistic missiles (IRBMs), which have now been retired, and SLBMs, which are now France's only ballistic missile deployment mode. Both types of missiles were deployed with countermeasures, which included MIRVs and decoys (see Appendix E).

Britain. Britain's long-range missile force has been composed only of SLBMs.⁴ No information is publicly available about countermeasures on Britain's current Trident-II SLBMs. However, the Polaris SLBMs they replaced deployed a complex countermeasures system known as Chevaline, which used a maneuvering bus to release two warheads and several heavy decoys on different trajectories. The system reportedly enclosed the warheads and decoys in balloons and released them along with a large number of empty balloon decoys. The decoys reportedly used small thrusters to compensate for slowing relative to the warhead due to atmospheric drag (see Appendix E).

Russia. Although it is believed that the Soviet Union had an extensive program to develop ballistic missile defense countermeasures, little public information about the details of this program is available. However, the level of Soviet activity on countermeasures during the early years of ICBM development is believed to have been comparable to that of the United States,⁵ and it is likely that countermeasures were at least developed if not deployed for most or all Soviet ICBMs and SLBMs. The 1999 US National Intelligence Estimate on the ballistic missile threat to the United States concluded that "Russia and China each have developed numerous countermeasures..."⁶ More recently, Yuri Solomonov, the chief designer of Russia's new Topol-M ICBM, indicated that this missile was designed with countermeasures in mind.⁷ Other Rus-

² Barry Miller, "Studies of Penetration Aids Broadening," *Aviation Week and Space Technology*, 20 January 1964, pp. 73-93.

³ Table 4-31 of Chuck Hansen's "Swords of Armageddon," states that the Minuteman II and III and MX missiles have countermeasures. Hansen, "Swords of Armageddon," CD-ROM, (Sunnyvale, Calif.: Chukelea Publications, undated) Vol. 7, pp. 490-491.

⁴ Sixty Thor intermediate-range missiles provided by the United States were deployed in Britain under a dual-key arrangement from 1958 to 1963.

⁵ "Penetration Aids," *Space/Aeronautics*, February 1964, pp. 47-48.

⁶ National Intelligence Council, "National Intelligence Estimate (NIE): Foreign Missile Development and the Ballistic Missile Threat to the United States Through 2015," unclassified summary, September 1999, p. 16.

⁷ See, for example, "Yuri Solomonov: US Missile Defense? There Is Still a Chance for Dialogue," *Yaderny Kontrol*

sian experts have stated that Russia has many types of countermeasures including decoys, chaff, and warheads that make midcourse maneuvers, which could be used to defeat an antimissile system.⁸ Of course, once added to a missile, countermeasures would accompany any launch, including an accidental or unauthorized one.

China. According to news reports, a 1997 classified US Air Force report concluded that since the end of the 1991 Gulf War, China has made accuracy and defense penetration primary goals of its new missiles, and that flight tests of CSS-5 missiles in November 1995 and January 1996 included the use of decoys.⁹ The first flight test of China's new DF-31 ICBM, on

2 August 1999, also included decoys, according to a classified 17 August 1999 report from the US Air Force's National Air Intelligence Center.¹⁰ The report further concluded that "Russia and China have each developed numerous countermeasures and probably will sell some related technologies." The 1999 US National Intelligence Estimate on the ballistic missile threat to the United States reached the same conclusion.¹¹ According to one Chinese defense expert, China's recent test of a spacecraft intended for manned flight demonstrated a low-thrust rocket propulsion system that could be used to make warheads maneuver to defeat an NMD system.¹²

Digest, No. 11, Summer 1999 (available at www.pircenter.org).

⁸ David Hoffman, "New Life for 'Star Wars' Response," *Washington Post*, 22 November 1999, p. 1.

⁹ Bill Gertz, "Chinese ICBM will Threaten US, Pacific by 2000," *Washington Times*, 23 May 1997, p. 1.

¹⁰ Bill Gertz, "China Develops Warhead Decoys To Defeat US Defenses," *Washington Times*, 16 September 1999, p. 1.

¹¹ National Intelligence Council, "NIE: Foreign Missile Development," p. 16.

¹² Associated Press, "Space Technology Could Beat US Defences, Scientist Says," *South China Morning Post*, 22 November 1999, p. 1.

Chapter 6

An Overview of Emerging Missile State Countermeasures

As we discuss in the previous chapter, the five original nuclear weapon states have in the past invested substantial effort and money in developing countermeasures to ballistic missile defenses and continue to do so. However, the question is often raised whether emerging missile states will have both the capability and incentive to deploy effective countermeasures to the US NMD system.

Some argue that the deployment of a US national missile defense will deter the development and deployment of missiles by emerging missile states because it would cast doubt on the effectiveness of such weapons.¹ This is only plausible if the steps emerging missile states could take to counter the defense were technically difficult or prohibitively expensive relative to acquiring ballistic missiles in the first place. As we discuss in this and subsequent chapters, this is simply not the case. Thus, if the United States deploys a national missile defense, it must expect that any adversaries interested in acquiring long-range ballistic missiles will continue to do so, and that countries that have acquired (at considerable expense and effort) long-range ballistic missiles to threaten the United States would also take steps to counter the defense by deploying countermeasures.

Any country that has both the technical capability and the motivation to build and potentially use long-range ballistic missiles would also have the technical capability and motivation to build and deploy countermeasures that would make those missiles useful in the presence of the planned US NMD system. Moreover, it must be assumed that a country that is developing long-range missiles with the intent of using or

threatening to use them would have a parallel program to develop countermeasures.² This is especially true in the current environment in which the US plan to build an NMD system is headline news.

The 1999 National Intelligence Estimate (NIE) of the ballistic missile threat to the United States, which was prepared by the US intelligence community, reached the same conclusions, stating that³

- “We assess that countries developing ballistic missiles would also develop various responses to US theater and national defenses. Russia and China each have developed numerous countermeasures and probably are willing to sell the requisite technologies.
- “Many countries, such as North Korea, Iran, and Iraq, probably would rely initially on readily available technology—including separating RVs [reentry vehicles], spin-stabilized RVs, RV reorientation, radar absorbing material (RAM), booster fragmentation, low-power jammers, chaff, and simple (balloon) decoys—to develop penetration aids and countermeasures.”
- “These countries could develop countermeasures based on these technologies by the time they flight test their missiles.”

² If a country purchases a long-range ballistic missile rather than developing its own, the United States must assume that the country selling the missile would be willing to sell countermeasures as well.

³ National Intelligence Council, “National Intelligence Estimate (NIE): Foreign Missile Development and the Ballistic Missile Threat to the United States Through 2015,” unclassified summary, September 1999.

¹ BMDO Fact Sheet, “National Missile Defense Program,” no. JN-99-05, March 1999, p. 2, available online at www.acq.osd.mil/BMDO/bmdolink/pdf/jn9905.pdf.

In this chapter, we provide an overview of countermeasures to the planned NMD system that would be available to an emerging missile state capable of deploying a long-range ballistic missile. Most of these countermeasures would be useful against any defense that used exoatmospheric hit-to-kill interceptors.

Some of the countermeasures discussed below would be effective for an attack using one missile, where others would be most effective if the attack involved more than one missile. As we discussed in Chapter 1, we will consider a limited attack of tens of missiles.

Some of the countermeasures we discuss in this chapter would be effective against one type of sensor but not against all of the planned NMD sensors. (The full defense will include ground-based radars that operate in the X-band and the UHF band, and satellite-based infrared and visible sensors. In addition, the kill vehicle will use visible and infrared sensors to home on its target. See Chapter 3 for more details.) We do not limit this discussion to countermeasures that are effective against the full suite of planned sensors for two reasons: different countermeasures can be combined together into packages that would be effective against all the sensors, and there are situations in which defeating only one type of sensor will defeat the defense.

We do not claim that the discussion here is comprehensive in that it includes all of the countermeasures that are both useful to an attacker seeking to penetrate the planned NMD and feasible for an emerging missile state to implement. Rather, this chapter is intended to give an idea of the range of techniques that might be employed by an emerging missile state seeking to defeat an exoatmospheric ballistic missile defense and to suggest those that might be most promising from the perspective of an attacker.

In the following chapters, we will focus on three of these countermeasures in much greater detail. These three countermeasures were chosen because they appear to combine high effectiveness against the planned NMD system with ease of deployment. For this reason, we will use the examples discussed in the next three chapters as a baseline threat for assessing the likely operational effectiveness of the NMD system. We believe the administration and Congress should also take these examples into account in their assessment of the system's effectiveness.

To best structure the discussion in this chapter, we group the countermeasures according to the general strategy they employ to defeat the defense. We discuss each countermeasure in more detail in the rest of the

chapter, but first describe them briefly here. An emerging missile state could

- Overwhelm the defense by deploying too many real targets for the defense to intercept. For an emerging missile state, this strategy is feasible for chemical or biological weapons delivered by submunitions.
- Overwhelm the defense by deploying too many false targets, or decoys, for the defense to intercept. The decoys are designed so the defense sensors are unable to discriminate them from the real warheads. There are several classes of decoys: (1) replica decoys, which replicate the warhead as closely as possible; (2) decoys using signature diversity, where the decoys are made to appear slightly different from each other and the warhead; and (3) decoys using anti-simulation, in which the warhead itself is disguised to mimic a decoy. Using anti-simulation, the attacker can disguise the warhead in several ways: for example, by enclosing it in a radar-reflecting balloon, by covering it with a shroud made of multilayer insulation, by hiding it in a cloud of chaff, by using electronic decoys, or by using infrared jammers (e.g., flares).
- Reduce the radar signature of the warhead. Doing so could reduce the range at which defense radars could detect the warhead and thus reduce the time available to the defense, and could make other countermeasures more effective.
- Prevent hit-to-kill homing by the kill vehicle, or make it more difficult, by reducing the infrared signature of the warhead. Doing so would reduce the range at which the infrared sensors on the kill vehicle could detect the warhead, leaving it less time to change course in order to hit the warhead. The attacker could reduce the infrared signature of the warhead by covering it with a low-emissivity coating or by using a shroud cooled to low temperatures by liquid nitrogen.
- Prevent hit-to-kill homing by hiding the exact location of the warhead. The attacker could hide the warhead by enclosing it in a very large metallized balloon or in one of a large number of smaller balloons tethered together. Doing so would prevent the defense sensors from

determining the location of the warhead, in which case the kill vehicle could only hit it by chance.

- Prevent hit-to-kill homing by making the warhead maneuver.
- Launch preemptive attacks on ground-based components of the defense system using cruise missiles or short-range ship-launched missiles, small airplanes, or special operations forces.

Overwhelming the Defense: Submunitions for Biological and Chemical Weapons

Here, the goal of the attacker is simply to present the defense with so many real targets that it is unable to intercept them all.

For missiles armed with biological or chemical warheads, an attacker can defeat a limited missile defense simply by packaging the biological or chemical agent in up to more than one hundred small warheads—called submunitions—rather than in one large unitary warhead. If we assume that an emerging missile state has only five long-range missiles, an attack could easily involve 500 submunitions. In this case, even if the defense expended all 250 of its interceptors, it could at best intercept half of the incoming submunitions, and thus reduce the amount of agent that reached the ground by a factor of two. However, doing so would not necessarily reduce the number of people killed or injured by a factor of two.

Using submunitions would not only overwhelm the defense, but would be a more effective way of dispersing the agent. Therefore an attacker would have a strong incentive to use submunitions to deliver these agents even in the absence of missile defenses. The use of submunitions to deliver chemical or biological agents is discussed in more detail in Chapter 7.

Since nuclear warheads cannot be subdivided into arbitrarily small parts, this strategy cannot be used for missiles carrying nuclear warheads. In this case, the most straightforward response to a limited defense deployment would be to deploy large numbers of warheads to overwhelm it. This could be done either by deploying a large number of missiles with single warheads or by deploying a smaller number of missiles with several warheads per missile. As discussed in Chapter 5, the United States, Russia, Britain, and France have all deployed multiple warhead missiles, largely motivated by concerns about the potential deployment of Soviet or US strategic missile defenses.

However, an emerging missile state is unlikely to be able to use this strategy to overwhelm the defense. Such states would have a limited capability to produce the fissile material needed for nuclear warheads, and their nuclear arsenals would thus likely consist of a small number of warheads. Moreover, deploying a large number of intercontinental missiles—whether they carry one or more nuclear warheads—would be a relatively expensive way of overwhelming a limited defense and may well be beyond the financial means of any of the emerging missile states.

Instead, an emerging missile state seeking to deliver a nuclear weapon via long-range missile would likely conclude that deploying a relatively small missile force with countermeasures is a more feasible and cost-effective approach to defeating a limited NMD system. Decoy warheads are one type of countermeasure that also relies on overwhelming the defense; we discuss these next.

Decoys: Overwhelming the Defense with False Targets

One important class of countermeasures uses a large number of decoys, or false targets, that the defense sensors cannot discriminate from the nuclear warhead. The defense then has to shoot at all the targets—real and simulated—to avoid letting the nuclear warhead penetrate unchallenged. But a limited defense would simply run out of interceptors if the attacker uses enough decoys.

As discussed in Chapter 3, the defense plans to fire multiple interceptors at each target to achieve a high probability of intercepting the warhead. If time permits, the defense plans to use a “shoot-look-shoot” strategy in which it will fire one or more interceptors, assess whether the target was intercepted, and then, if necessary, fire additional interceptors. The final system planned for deployment would have up to 250 interceptors deployed at two sites—one in Alaska and one in North Dakota.

To avoid wasting interceptors (and potentially running out of them), the planned NMD intends to discriminate decoys from warheads. However, even if its sensors are not able to discriminate the warheads from the decoys, the defense could still choose to fire all its interceptors to intercept as many of the incoming objects as possible. In this way, the defense would have some chance of intercepting the warhead and preventing any damage on the ground. However, the effectiveness of the defense system would be greatly reduced

if the attacker deploys a large number of decoys. For example, if an emerging missile state with only ten missiles deploys a total of two nuclear warheads and 500 decoys, a defense with 250 interceptors will have less than a 50 percent chance of intercepting each warhead, and less than a 25 percent chance of intercepting both warheads. Thus, the attacker will have at least a 75 percent probability of getting a warhead through the defense.

Of course, the defense might not want to use all its interceptors at once, but would likely reserve some for later use. For example, the defense might be concerned that the ten missiles launched were only carrying decoys, and that the attacker would launch more missiles with nuclear warheads a short while later. If the defense had launched all its interceptors against the first ten missiles, there would be none left to intercept the nuclear warheads on the remaining missiles.

Decoys are a particularly attractive strategy against exoatmospheric defenses. Decoys designed to defeat an exoatmospheric defense take advantage of the fact that there is no atmospheric drag in the vacuum of space, so that lightweight objects travel on trajectories identical to that of a much heavier warhead. Because the decoys can be lightweight, the attacker can use a large number of them. (Because both the size and range of a missile depends on the weight of the payload it is carrying, there is in general an incentive to limit the payload weight to achieve a greater range and/or to limit the overall size of the missile.)

As such lightweight decoys and the warhead begin to reenter the atmosphere, the decoys would be slowed down more rapidly by atmospheric drag, allowing the warhead to be identified. However, depending on the altitude at which such slowing and warhead identification occurs, it might be too late for an above-the-atmosphere interceptor to intercept the warhead before it passed below the interceptor's minimum intercept altitude. Moreover, for attacks against targets far from the interceptor deployment site, the defense would need to launch its interceptors before the lightweight decoys could be discriminated. This in itself would cause problems for the defense, since it would need to commit its interceptors before it knows whether timely discrimination is even possible. The attacker could exploit this uncertainty by using a mix of lightweight and somewhat heavier decoys. In general, the heavier a decoy is, the lower in the atmosphere it would go before the defense could discriminate it.⁴ Moreover, if the defense

⁴ The altitude at which discrimination could occur would depend on the ballistic coefficient of the decoy, $\beta = W/(C_D A)$,

has to intercept high within the atmosphere rather than above the atmosphere, it would not have time to assess whether the first interceptors missed the target before launching additional interceptors and would be unable to use its planned "shoot-look-shoot" strategy.

Several different decoy strategies are possible. Below, we discuss three categories of decoys: replica decoys, decoys using signature diversity, and decoys using anti-simulation. Although these are presented as distinct approaches, in actual practice there are likely to be overlaps between them.

Replica Decoys. Perhaps the most obvious approach would be to deploy large numbers of decoys that are intended to be indistinguishable in appearance from the nuclear warhead (indistinguishable to the defense sensors, but not necessarily to the human eye), but are much lighter in weight. Such decoys are known as *replica decoys*. If successful, the use of replica decoys would leave the defense with the choice either of firing at every possible target, which, depending on the relative number of interceptors and decoys, may not be possible, or of letting the warhead penetrate unchallenged. While replica decoys are probably what most people imagine when they think about decoys, they are not necessarily the most effective decoy approach, as we discuss below. Figure 6-1 is a photograph of a US replica decoy that was deployed in the 1960s.

Given the high measurement resolution of the NMD X-band radars, a replica decoy would need to be very similar in shape to the warhead and have a similar radar cross section. It might also need to mimic any dynamical characteristics of the warhead, such as the rotation about its axis and any wobbling in this rotation. In order to be effective against SBIRS-low, a replica decoy would also need to have a similar temperature and emit a similar amount of infrared energy as the warhead in the wavelengths used by the defense sensors.⁵ Doing so might require putting a heater in the decoys.

It should be possible for an emerging missile state to construct and deploy credible replica decoys that are much lighter than a nuclear warhead and that could be deployed in significant numbers by a long-range ballistic missile delivering such a warhead. The American Physical Society's Directed-Energy Weapons study

where W is the weight, C_D is the drag coefficient, and A is the cross-sectional area.

⁵ The requirement that the decoy emit a similar amount of infrared energy means that the product of the decoy's surface area and emissivity must be similar to that of the warhead.



Figure 6-1. Photograph of a US replica decoy for the MARK IV reentry vehicle that was used on some Titan ICBMs. US Air Force photo 113217 USAF, dated 19 October 1961, reprinted from Chuck Hansen, "Swords of Armageddon," CD-ROM (Sunnyvale, Calif.: Chukelea Publications, undated) Vol. 7, p. 560.

concluded that such decoys might weigh as little as a "few kilograms including dispensing and erection hardware."⁶ This figure presumably was an estimate for the Soviet Union, but given the relative simplicity of such decoys, this figure seems plausible even for an emerging missile state.

Decoys Using Signature Diversity. A potential attacker considering the use of replica decoys may be concerned that the defense will be able to identify and exploit some small observable difference between the warhead and the decoys. One way to address this issue would be to modify the decoy strategy to exploit the fact that while the defense might know the general characteristics of the warhead, it would not know the exact characteristics. Thus, rather than trying to exactly replicate the warhead, the decoys would be made to have slightly different signatures from the warhead and from each other. This would prevent the defense from picking out the warhead as the one object that was different from the rest.

For example, the attacker could use cone-shaped decoys with the same shape as the nuclear warhead, but of slightly varying lengths and nose radii of curvature. Such decoys would have slightly different radar cross sections from the warhead and each other. Because they would have the same shape, several of these decoys could be stacked over the warhead inside

the nosecone of the missile. Small weights on the inner surface of the cones could be used to control their moments of inertia so that each one would wobble in a manner similar to (but slightly different from) the warhead. The attacker could also diversify the infrared signature of the decoys by using small heaters or, for daylight attacks, different surface coatings that would result in different decoy temperatures.

Decoys Using Anti-simulation. With anti-simulation, the attacker takes the deception one step farther by modifying the appearance of the warhead. Rather than making a decoy simulate the warhead, the attacker disguises the nuclear warhead. By introducing variability into the warhead appearance, a wide range of decoy characteristics can be made compatible with those of the warhead, thus greatly complicating the decoy discrimination problem for the defense. Indeed, when the possibility of altering the warhead appearance is taken into account, it is clear that there is no need for the decoy to resemble a bare warhead at all. The attacker can either use decoys that are similar in appearance to the disguised warhead, or exploit the advantages of signature diversity by using decoys that vary in appearance, differing from the warhead and each other.

Anti-simulation techniques can also be used to defeat a defense strategy commonly used to deal with large numbers of potential targets—"bulk filtering." In this technique, objects with characteristics that are a poor match to those the defense expects the warhead to have are either not observed because of sensor filters or observed very briefly and immediately rejected without the need for a detailed examination. This approach allows large numbers of false targets to be screened out rapidly, but is vulnerable to being deceived by anti-simulation techniques. If the attacker disguises the warhead, this could lead the defense to reject the warhead itself as a possible target. The attacker could also deploy at least one decoy that would have observed characteristics similar to what a bare warhead would have.

The attacker can modify the appearance of the nuclear warhead in many different ways. By changing its shape, the attacker can change the radar cross section of the warhead as measured by an X-band radar by several orders of magnitude. By changing its surface coating, the infrared signature of the warhead can change by more than an order of magnitude. Or, as we discuss in more detail below, the attacker can disguise the warhead by enclosing it in a radar-reflecting balloon, by covering it with a shroud made of multilayer insulation, by hiding it in a cloud of chaff, or by using electronic radar jammers.

⁶ American Physical Society Study Group, "Science and Technology of Directed Energy Weapons," *Reviews of Modern Physics*, Vol. 59, no. 3, Part II, July 1987, p. S153.

Metallized Balloons. One anti-simulation strategy would be to enclose the nuclear warhead in a metallized mylar balloon, similar to but larger than those sold at supermarket checkouts. This would be released along with a large number of empty balloons. Because radar waves could not pass through the thin metal coating, the radars could not determine what was inside each balloon. However, a nuclear warhead gives off heat and could thus heat the balloon enclosing it. To prevent discrimination by infrared sensors, the attacker could control the temperature of each balloon by equipping it with a small heater. Alternatively, for attacks during daylight, the thermal behavior of the balloons could be controlled by passive means: the attacker could set the temperature of each balloon by choosing a surface coating with a specific solar absorptivity and infrared emissivity. For attacks during nighttime, the temperature of the balloons will not depend on the surface coating, but can be varied by varying the shape of each balloon (see Appendix A).

Although each balloon could be made similar in appearance, it might be even more effective to make each balloon different in shape and to design them to achieve a range of different temperatures. In this case, each balloon—including the one with the warhead—would look different to the NMD sensors, and none of them would look like a bare warhead. We discuss this metallized balloon countermeasure in more detail in Chapter 8.

Shrouds of Multilayer Insulation. Alternatively, the attacker can conceal the nuclear warhead in a shroud made of thermal multilayer insulation and release it along with a large number of empty shrouds. Thus, the anti-simulation decoys are simply empty shrouds with a lightweight frame and of a size and shape that could cover a warhead. The frame could be collapsible (like an umbrella). Alternatively, several decoys could be packed over a conical warhead, Dixie-cup style, which would also avoid crushing the insulation.⁷

Multilayer insulation consists of many layers of metallized plastic (such as aluminized mylar) with very thin spaces between the layers.⁸ It is a very effective

insulator commonly used to maintain an object at a low temperature in a vacuum.⁹ A shroud made of this material would effectively conceal the thermal effects of the warhead, so that there would be no need to cool (or heat) the warhead to match the temperature of an empty shroud. Moreover, because radar waves could not penetrate the metallic covering of the shrouds, the defense radars could not determine which shroud contained the warhead.

To prevent discrimination by the X-band radars, the attacker would also need to prevent the empty shrouds from behaving differently from the shrouded warhead. Because the empty shroud may not be rigid, it may begin to wobble or spin around a stable axis. However, the attacker can avoid this behavior by properly weighting the frame to which the insulation is attached.

Chaff. Rather than hiding the nuclear warhead within a balloon, the attacker could hide it within a cloud of radar-reflecting chaff strands, while also deploying chaff clouds without warheads. Since the radar would not be able to detect the presence of the warhead within the chaff cloud, each of the chaff clouds not containing a warhead would in effect act as a decoy.

A piece of chaff is simply a conducting wire cut to a length that maximizes its radar reflections, which is one-half the radar wavelength. For the planned NMD X-band radars, the appropriate length of a piece of chaff is about 1.5 centimeters (0.6 inches), whereas chaff effective against the early-warning radars would be 0.35 meters (1.1 feet) long.¹⁰ Assuming that the warhead has been properly shaped to reduce its radar cross section (see Appendix C) and is oriented with respect to the radar so as to maintain this low radar cross section, each chaff wire would have a radar cross section comparable to that of the warhead.¹¹ Since one pound

⁷ This is presumably the approach used by a warhead shaped decoy named “Dixie Cup” that was investigated by Philco-Ford Corporation for the Air Forces in the mid-1960s. See “Filter Center,” *Aviation Week and Space Technology*, 28 November 1966, p. 94.

⁸ The layers are largely prevented from touching one another by small plastic spacers at intervals large compared to the spacer size.

⁹ The vacuum between any two layers greatly reduces the heat transfer by conduction, and the highly reflective metallization reduces the heat transfer by radiation with an effectiveness that increases geometrically with the number of layers. Multilayer insulation is punctured with many small holes to permit the air to escape quickly in a vacuum.

¹⁰ In practice, the chaff strands would be cut to a number of slightly varying lengths to account for the ability of the radar to operate over a span of frequencies.

¹¹ The attacker would choose the orientation of the warhead according to the location of the defense radars, which would be known to the attacker. While this orientation might not be the optimal one for reentry, since the attacker would not be trying (nor able) to achieve high accuracy, this is unlikely to be a serious concern. On some trajectories, it may be possible for several radars to simultaneously observe

of chaff could contain millions of chaff wires, the attacker could deploy numerous small chaff dispensers that would create many chaff clouds, only one of which would contain a warhead. The radar reflections from the chaff strands would prevent the X-band and early warning radars from determining which cloud contained the warhead. Because the chaff strands would be spreading radially outward from the dispenser, each dispenser would emit strands continuously over the roughly 20 minutes it is traveling through space to maintain a high density of chaff strands near the dispenser (where the warhead, if there was one, would also be located).

Because chaff clouds would only prevent discrimination by radar, the attacker would need to use other means to prevent the SBIRS-low satellite-based infrared sensors from discriminating the chaff cloud with the warhead from the empty chaff clouds. One possibility would be for the attacker to use flares in each chaff cloud to generate a large infrared signal that would overwhelm that of the warhead. Or the attacker could deploy a plastic balloon, possibly with a small heater inside each of the chaff clouds that did not contain the warhead.

Electronic Decoys. Another anti-simulation strategy is to drown out the reflected radar signals from the nuclear warhead by placing an electronic radar source on the warhead; this technique is known as “jamming.” The decoys would then simply be electronic radar jammers without the warhead. Thus, jammers can be used both to produce false targets and to disguise the warhead.

Because modern missile defense radars, such as the planned X-band radars, can operate anywhere within a wide frequency range and can change frequency rapidly, a simple broad-band jammer (like those used in World War II) that would drown out the radar over all the possible frequencies it could be operating at would need to be very powerful.¹² For this reason, the attacker is likely to prefer electronic decoys that return a signal

the warhead from widely different directions; in this case it might be difficult or impossible for the attacker to shape the warhead or its shroud so that it simultaneously has a low radar cross section as viewed by each of the radars.

¹² For example, consider a radar able to operate over a 1 GHz range of frequencies. The jammer would have to spread its energy over this entire band of frequencies. But a radar pulse with a length of 1 μ sec (or chain of coherently integrated pulses) would have a bandwidth of only 1 MHz, and only 0.1% of the jammer’s energy output would be within this bandwidth.

at the same frequency the radar uses and can therefore be very low power.

As the 1999 NIE noted, low-power jammers are readily available technology. Electronic radar jammers can be made using commercially available transponders to return identical signals from both warheads and decoys.¹³ Small antennas on the nose of the warhead and decoys would receive the radar signals sent by the defense radars; the signals would then be amplified and stretched in time, by a variety of methods, to last somewhat longer than the radar signal reflected by the bare warhead, and returned to the radar. The defense radars would thus receive identical returns from the transponders on the warhead and the decoys, which would overwhelm the smaller signals that are reflected from the warhead and decoys themselves. The attacker could also use signature diversity: by designing each transponder to emit somewhat different signals so that every potential target had somewhat different characteristics, the attacker would prevent the defense from searching for the one target that is slightly different from all the others.

Because commercially available antennas and amplifiers have a very wide frequency response,¹⁴ the attacker would not need to know the precise frequency of the defense radar, nor could changes of the radar frequency within its operating range reveal which target is the warhead and which is a decoy. Moreover, antennas of the type needed, particularly “spiral” type antennas, can be made very small, as small as a centimeter in diameter. Lightweight electronic decoys weighing no more than a few kilograms could be made using such antennas and lightweight amplifiers and power supplies, allowing large numbers of such decoys to be deployed along with the actual warhead. Because the electronic equipment is small, the decoys could also be packaged into small conical shapes with relatively high ballistic coefficients. This would permit the decoys to penetrate deeper into the atmosphere than some other types of lightweight decoys. (See Figure 6-2 for a schematic drawing of a US Navy electronic reentry decoy.)

Since antennas are available that are essentially isotropic in their response over a wide range of angles, the

¹³ Sherman Frankel, “Defeating Theater Missile Defense Radars with Active Decoys,” *Science and Global Security*, Volume 6 (1997), pp. 333–355, and Sherman Frankel, “Countermeasures and Theater Missile Defense,” *Surface Warfare*, July 1996, pp 38–40.

¹⁴ See for example, antenna catalogues from Marconi Aerospace Electronic Systems, Inc., 305 Richardson Road, Lansdale, Pennsylvania.

attacker can prevent any nutation and other motions of the warhead and decoys about their spin axis from producing detectable changes in the transponder's signal. Moreover, by varying their amplification with time, the transponders could also simulate such nutations electronically. In addition, since modern radars can store and analyze sequences of signals, to hide any possible correlations between successive return signals, the transponders (including the one on the warhead) could send back signals that differ from radar pulse to radar pulse.

More generally, the use of modern microchip technology could permit even emerging missile states to deploy a whole new class of "intelligent decoys" that could improve on these simple transponder decoys.

These electronic decoys would prevent discrimination by the defense radars. The attacker would need to take additional steps to prevent discrimination by the SBIRS-low infrared sensors.

Late Deployment of Decoys. When attempting to defend a country as large as the United States with interceptors at a few sites, there is a great premium on being able to launch interceptors as early as possible after the launch of an attacking missile, both to allow the greatest time for the interceptor to reach its target and, ideally, to permit firing multiple interceptors at different times in a shoot-look-shoot strategy. Depending on the relative location of the missile launch point, the target against which the missile is launched, and the interceptor launch site, the attacker could attempt to exploit long interceptor fly-out times by withholding the deployment of decoys until after all the interceptors have been committed. In this case, the defense would have committed its interceptors before it knew how many decoys would be deployed and whether it

could discriminate them from the warhead. A North Korean attack on Hawaii might be one scenario where this tactic could be effective. One disadvantage of this approach is that decoy deployment would likely occur in full view of the X-band radars, raising the possibility that the defense could discriminate the decoys by observing their deployment.

Reducing Radar Signatures

By reducing the radar signatures of the targets, the attacker could decrease the range at which the target would be detected by the defense radars, and hence the time available for the defense to act. This would make the job of the defense more difficult and could make other countermeasures possible or more effective. For example, an attacker would almost certainly need to reduce the radar cross section of a nuclear warhead if chaff is to be used to hide the warhead.

The attacker could reduce the radar cross section of the nuclear warhead by shaping the reentry vehicle (or a shroud around it) to minimize radar reflections back to a radar and/or by using radar-absorbing material on the surface of the reentry vehicle or shroud. The attacker might choose to use a shroud if the shape of the warhead itself did not make a low radar cross section easy to achieve. For example, as discussed in Appendix C, the attacker could give the warhead the shape of a sharply-pointed cone with a rounded back end (a cone-sphere), which would reduce its nose-on radar cross section for the X-band radars by a factor of about 10,000 relative to a cone with a flat back, to roughly 0.0001 square meters. While the radar cross section would be lowest if such a warhead was viewed nose-on by the radar, it would also be significantly reduced over a wide range of angles around nose-on, at least ± 60 degrees. Thus, the attacker would need to use some degree of orientation control to keep the warhead pointed in the general direction of the radars, which is feasible. The 1999 National Intelligence Estimate stated that "RV reorientation" is a technology that is readily available to emerging missile states.¹⁵

Shaping the RV would not be as effective against the early warning radars, since their wavelength of roughly 0.66 meters is comparable to the dimensions of the warhead. Nevertheless, by using a cone-sphere the attacker could reduce the observed radar cross section by a factor of ten or more—to roughly 0.01 to 0.1 square meters.

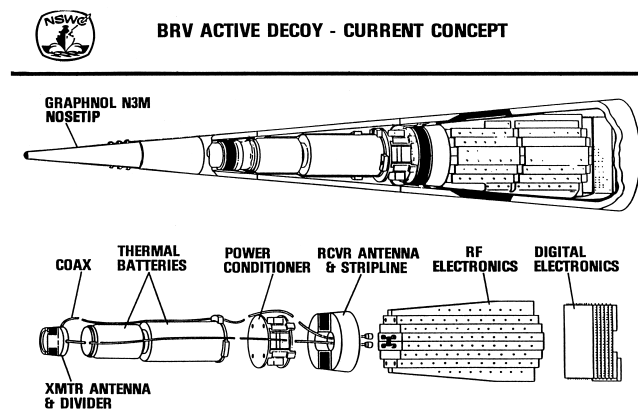

Figure 6-2. A schematic drawing of a US Navy electronic reentry decoy from a Naval Surface Weapons Center briefing (1984).

¹⁵ National Intelligence Council, "NIE: Foreign Missile Development," p. 16.

By reducing the warhead's radar cross section in this way, the attacker may be able to significantly degrade the range at which a given radar could detect the warhead. However, depending on the trajectory of the warhead, the radar detection range might be limited more by the horizon. For some trajectories, the warhead would not rise over the horizon until it was close enough to the radar that it could be detected with a reduced radar cross section.

What is likely more significant is that by reducing the radar cross section of the warhead and decoys, the attacker would degrade the ability of the X-band radars to discriminate different objects from one another. Moreover, the attacker would need to reduce the radar cross section of the warhead to implement other possible countermeasures, such as the use of chaff clouds.

Prevent Hit-to-Kill by Infrared Stealth

By reducing the infrared signature of its nuclear warhead, the attacker could reduce the detection range of both the SBIRS-low infrared sensors and of the kill vehicle's infrared seeker. Even if the warhead's infrared signature could be reduced sufficiently to prevent detection by SBIRS-low infrared sensors, this would not necessarily defeat the defense since the warhead could still be tracked by the defense radars (and possibly by the SBIRS-low visible-light sensor). However, the smaller infrared sensors on the kill vehicle would not have as great a range as those on SBIRS-low, and the performance of the kill vehicle would depend critically on how much time it has to maneuver to hit its target and thus on how far away it can detect the target. By reducing the infrared signature of the warhead, the attacker might be able to reduce the detection range of the kill vehicle's infrared seeker enough so that the kill vehicle either could not detect the warhead or did not have enough time to home on the warhead after detecting it. In this case, the defense would fail catastrophically, even if the warhead could be tracked by the defense radars and SBIRS-low. We discuss two ways an attacker could reduce the infrared signature of a warhead.

Low-Emissivity Coatings. One way to reduce the signature of the warhead would be to cover it with a low emissivity coating, since the infrared signature of the warhead is determined by its temperature and the product of its emissivity and surface area. A warhead covered with a carbon-based or wood ablative covering would have an infrared emissivity of about 0.9 to 0.95, while a warhead with an outer surface of unpolished steel would have an emissivity in the range of 0.4

to 0.8. If the warhead was instead covered with a thin polished gold coating (with an emissivity of about 0.02), its emissivity would be reduced by a factor of about 20 to 40.

Since a gold-covered warhead would tend to warm up to well above room temperature in sunlight (see Appendix A on the thermal behavior of objects in space), this approach would be best suited to trajectories that were completely or largely in the earth's shadow. On such nighttime trajectories, a heavy warhead would slowly cool below its initial temperature, which we assume is room temperature (300 K). However, the attacker could reduce the infrared signature of the warhead even further by instead enclosing the warhead in a thin, gold-plated balloon that was thermally insulated from the warhead (see Chapter 8 for a discussion of how this could be done). Such a balloon would quickly cool to nearly its nighttime equilibrium temperature of about 180 K. If the balloon reached an equilibrium temperature of 200 K, its infrared signature would be further reduced by a factor of about 10 (for infrared sensors in the 8 to 12 μm band) to 200 (for sensors in the 3 to 5 μm band) relative to that of a balloon at 300 K. Thus, by using this entirely passive approach, an attacker could reduce the infrared signature of the warhead by a factor of 200–400 (8 to 12 μm band) to 4,000–8,000 (3 to 5 μm band). This would correspond to a decrease in the kill vehicle detection range by a factor of from 14–20 (8 to 12 μm band) to 60–90 (3 to 5 μm band), which would significantly reduce the time available for the kill vehicle to maneuver to hit the warhead.

As we discuss in Chapter 9, the attacker would need to orient the warhead to make sure that earth infrared radiation reflected from the warhead would not reach the infrared sensor.

Cooled Shroud. Using low emissivity coatings or passive cooling may not reduce the range at which the warhead could be detected enough to prevent the defense kill vehicle from detecting and homing on the warhead. The attacker could obtain a much greater reduction in detection range by enclosing the nuclear warhead in a cooled shroud. Such a shroud could be isolated from the warhead by commercially available superinsulation material and be cooled by a small quantity of liquid nitrogen. Cooling the shroud to liquid nitrogen temperature (77 K) would reduce the infrared signature of the warhead by a factor of at least one million relative to its signature at room temperature.¹⁶ The warhead would then be effectively invisible to the kill vehicle. Again, the attacker would need

to take care to prevent reflected radiation from reaching the infrared sensor on the kill vehicle. This countermeasure would work even if the warhead were detected and tracked by the defense radars; however, the shroud could also be shaped to reduce its radar cross section against the X-band radars. This cooled shroud countermeasure is discussed in more detail in the Chapter 9.

Prevent Hit-To-Kill Homing by Hiding the Warhead

Another set of countermeasure strategies would exploit the fact that a hit-to-kill interceptor must hit its target directly to destroy it.

For example, the attacker could enclose the warhead in a large metallized balloon, with a radius of, say, 5 meters or larger. If the kill radius of the hit-to-kill interceptor is much smaller than the balloon, it would be unlikely to hit the warhead inside the balloon even if it hits the balloon itself. In fact, the attacker can make the kill probability as small as desired by increasing the radius of the balloon. The attacker might be concerned that the balloon itself would be destroyed by the impact of the interceptor (which would depend in part on how the balloon was constructed), thus leaving the warhead exposed for a second interceptor to hit. In this case, the attacker could pack additional balloons around the warhead to be sequentially inflated as their predecessors were destroyed.

As another alternative, rather than using a single large balloon, the attacker might use a cluster of perhaps dozens of closely spaced tethered balloons, only one of which contains the warhead. These would be spaced closely enough so that SBIRS-low could not assist in discrimination, and if necessary (for example, at night) the balloons without the warhead might contain heaters to simulate the heat radiated from the warhead. In this case, each kill vehicle would at best be able to destroy a few of these many balloons, making small the odds of destroying the warhead.

Warhead Maneuvers

Another countermeasure strategy would be for the warhead to make unexpected maneuvers to confuse the interceptor or disrupt the kill vehicle's homing process. As discussed in Chapter 5, Russian countermeasures

reportedly include warheads that make midcourse maneuvers,¹⁷ and China's recent test of a spacecraft intended for manned flight demonstrated a low-thrust rocket propulsion system that reportedly could be used to make warheads maneuver to defeat an NMD system.¹⁸ Emerging missile states could also use this strategy.

To maneuver outside the atmosphere (where the exoatmospheric NMD interceptors would intercept their targets), the warhead would need to use thrusters. Although maneuvering continuously using thrusters would require too much fuel to be practical, one maneuver or a series of several preplanned maneuvers could disrupt the defense.

For example, an attacker could also use a series of preprogrammed warhead maneuvers as a complement to lightweight decoys that the defense could discriminate below a given altitude. In this case, the warhead would make a series of maneuvers to bridge the gap between the altitude at which the decoys would be screened out and the minimum intercept altitude of the NMD interceptor.

Preemptive Attacks on Defense Components

Some of the defense components, particularly the ground-based radars and the in-flight interceptor communications systems (IFICS), could be quite vulnerable to attack. It is unlikely, for example, that the planned NMD system could even attempt to defend its radars in Britain against a missile attack from Iran or Iraq. Other forward-based radars, such as those in the Aleutians, on Greenland and on the US coasts, could be vulnerable to short-range ship-launched cruise missiles or radar-homing missiles, attacks delivered by civilian or military aircraft, or even by attacks by agents or special operations forces using shoulder-fired rockets. If such attacks succeeded in eliminating several or even one of the radars, it would leave gaps in the radar coverage so that the defense would be dependent only on SBIRS-low for interceptor guidance against incoming missiles on certain trajectories. Without X-band radar coverage, the defense's ability to discriminate decoys from warheads would be severely degraded, putting the defense at a great disadvantage. If an attack destroyed one of the IFICS, this could prevent the defense from communicating with its interceptors.

¹⁶ For an infrared sensor that operates at a wavelength of 10 μm , the infrared signature would be reduced by a factor of a million; for a sensor that operates at 5 μm , the reduction would be a factor of a trillion.

¹⁷ David Hoffman, "New Life for 'Star Wars' Response," *Washington Post*, 22 November 1999, p. 1.

¹⁸ Associated Press, "Space Technology Could Beat US Defences, Scientist Says," *South China Morning Post*, 22 November 1999, p. 1.

Chapter 7

Emerging Missile State Countermeasure 1: Submunitions with Biological or Chemical Agents

As we have seen in the previous chapter, there are many types of countermeasures that an emerging missile state could use.

We believe the planned NMD program has seriously underestimated the effectiveness of the simple countermeasures that would be available to an emerging missile state and has overstated the technical difficulties in developing and building such countermeasures.

In this chapter and the following two, we describe in detail three such countermeasures that could defeat the planned NMD system. These are: (1) biological or chemical weapons deployed in submunitions that would overwhelm any limited NMD system, (2) nuclear weapons deployed with numerous balloon decoys using anti-simulation techniques that would overwhelm the planned NMD system, and (3) nuclear weapons deployed with a cooled shroud that would prevent the planned hit-to-kill interceptor from homing on it.

It is essential that the United States accurately define the baseline ballistic missile threat from emerging missile states; otherwise, any assessment of the operational effectiveness of the planned NMD system will be meaningless. The question “Will it work?” can only be asked in the form “Will it work against what?” The threat that the NMD system appears to be designed against is simply not realistic. At a minimum, the baseline threat should include the three delivery options and countermeasures discussed in this and the next two chapters.

Should the Baseline Threat Include Chemical and Biological Weapons?

Discussions of the potential threats from emerging missile states tend to focus on ballistic missiles armed with nuclear warheads. That focus may not be justified, however.

The three emerging missile states of greatest concern to the United States—North Korea, Iran, and Iraq—are all reported to have programs to weaponize chemical and biological agents. Once successful, these countries could presumably produce large amounts of these agents and have a far larger stockpile of these weapons than of nuclear weapons. North Korea, for example, is believed to have enough fissile material to produce possibly two nuclear weapons and is not believed to currently have the capability to produce significant additional quantities. It may, therefore, see its few nuclear weapons (assuming it is able to weaponize its fissile material) as too scarce and valuable to fire on a relatively untested ballistic missile of unknown reliability, preferring instead to deliver them by a more reliable method, such as by ship. Arming missiles with chemical or biological warheads, which would be more plentiful, would therefore make sense.

If the United States is concerned about ballistic missile attacks from emerging missile states, then it must include biological and chemical warheads in the baseline threat the NMD system would need to defend against.

Submunitions

The most effective method for delivering chemical or biological (CB) weapons by ballistic missile is to divide the missile’s payload into 100 or more bomblets, or submunitions, each carrying up to a few kilograms of CB materials.¹ Shortly after the missile booster burns out, these bomblets would be released from the

¹ For chemical weapons, all of this material would be the active agent. For biological weapons, the active agent might only be only a fraction of this quantity, with the rest being inert materials such as anti-caking substances if the material is in powder form or a liquid if it is in slurry form.

warhead in a way that makes them spread out in a cloud as they travel through space toward the target. Each of these bomblets would then land at a slightly different location, thereby dispersing the agent more effectively than would be possible if delivered in one large “unitary” warhead. A warhead using bomblets could easily be designed to disperse several hundred kilograms of CB materials over a region 10–20 kilometers in diameter.²

For biological weapons, even the small quantity of agent carried in a bomblet can be extremely lethal. For example, the M143 bomblet developed by the United States carried only about 6 grams of anthrax spores in a slurry, but this corresponds to 300 million lethal doses (in the hypothetical situation in which it is administered as an aerosol with no loss to the atmosphere).³

The analysis presented in this section shows that, if a country has developed chemical or biological agents suitable for delivery by ballistic missile, there would be no technical barriers to that country delivering those agents in bomblets rather than a single, large warhead. We show below that the chemical or biological agents in the bomblets can be protected from reentry heating using standard heatshield materials that were developed thirty years ago, and that this heatshield would also protect the agent from heating or cooling of the bomblet during its 30-minute flight. We also show that the atmosphere would slow bomblets to aircraft speeds at low altitudes, and that this has a number of advantages for the attacker. For example, it makes dispersal of the agent easier than for a unitary warhead, and it allows more thorough testing of the bomblets since testing can be done from aircraft.

It is clear that if the attacker successfully deploys submunitions this measure would defeat the defense since there would simply be too many targets for the defense to intercept. Thus, there is no need to test the NMD system against submunitions. Instead, the Pentagon should make clear that the planned NMD system is neither designed to nor capable of defending against

chemical or biological agents delivered by missiles using submunitions.

US missile defense programs provide a strong incentive for countries to develop and deploy submunitions since they would be highly effective countermeasures to the planned NMD system, as well as to many US theater missile defense systems. If the submunitions are released from the missile shortly after its boost phase ends, they would overwhelm any missile defense system designed to intercept its targets after the boost phase (such as the planned NMD system).⁴

However, regardless of US missile defense plans, a country planning to deliver chemical or biological weapons by ballistic missile would have a strong motivation to divide the agent into a large number of small bomblets rather than to use a single large warhead, since bomblets offer a number of important advantages to the attacker.

The most important advantage is that bombets can disperse CB agents more effectively than a unitary warhead, for several reasons. The first is the problem of oversaturating a small area with agent by using a unitary warhead. A unitary warhead delivers a large amount of agent to the impact point, and relies on air currents to spread it over a larger area. The concentration of agent will be highest near the impact point and will decrease as the agent spreads away from that point. Making the concentration large enough to deliver a lethal dose far from the impact point means that the concentration at the impact point is much larger than required to give a lethal dose, and any agent beyond what is required for a lethal dose is simply wasted. Delivering smaller concentrations to many points using submunitions reduces this overcontamination problem.

The importance of spreading out chemical and biological agents using submunitions to avoid simply overcontaminating a small region was recognized early and

² The Pentagon has also voiced concern about the possibility of countries developing radiological submunitions, in which a small conventional explosive could be used to scatter radioactive materials such as cobalt 60 or strontium 90. (David Fulghum, “Small Clustered Munitions May Carry Nuclear Wastes,” *Aviation Week and Space Technology*, 11 October 1993, p. 61.)

³ A lethal dose of anthrax is reported to result from inhaling 10,000–20,000 spores (See, for example, SIPRI, *CB Weapons Today*, p. 67.)

⁴ We note that there have been reports that the ERINT interceptor of the PAC-3 theater missile defense system was successfully tested against submunitions carrying simulated chemical agent. This refers to an intercept test on 30 November 1993 in which ERINT intercepted a target missile carrying 38 canisters filled with water intended to simulate chemical weapons submunitions. (David Hughes, “Army Selects ERINT Pending Pentagon Review,” *Aviation Week and Space Technology*, 21 February 1994, p. 93.) However, in this test the submunitions were not dispersed early in flight; instead the canisters were all clustered together in a single package, which makes no sense from the point of view of an attacker facing a missile defense. So this test did not demonstrate that submunitions could be defeated by a terminal defense system.

grew out of work on mustard gas during World War II. The first development was of cluster bombs for aircraft, but submunitions for missiles were soon designed as well.⁵

The second advantage of bomblets is that they can be distributed in a pattern that covers a greater portion of a city with the agent than is possible with a unitary warhead. When the agent is dispersed from the impact point of a unitary warhead, the wind carries it in a long, narrow plume, which cannot cover a city effectively.

In addition, by spreading out the bomblets over a large area, an emerging missile state can help compensate for the poor accuracy of its ballistic missiles. Missile inaccuracy could easily be several kilometers or more, especially under the assumption that the missile would undergo only a limited flight-test program.⁶

A final advantage of bomblets is that, at low altitude, atmospheric drag slows them to much lower speeds than unitary warheads. Since bomblet speeds at these altitudes are typical of aircraft speeds, some methods of dispersing the agent from the bomblets may be possible that are not possible with unitary warheads.⁷

The total mass of the casings, heatshields, and dispensing mechanism for a chemical or biological warhead using bomblets would be expected to be greater than the mass of the casing and heatshield for a unitary warhead. Thus a missile equipped with bomblets would be able to carry less agent than would a unitary warhead. Such a trade-off is sometimes referred to as a “payload penalty.” However, for bomblets this should not be considered a penalty, since the net result is more effective delivery of the agent. This is precisely what led the United States to develop bomblets for chemical and biological agents on aircraft and short-range ballistic missiles (see box for more details).

Would an emerging missile state encounter any

technical barriers to using submunitions? Below we examine the key technical issues a country would face in building and deploying submunitions and find that an attacker would face no such technical barriers.

The development of submunitions of various types began in the 1940s and effective heatshield materials for ballistic missiles existed in the 1960s. Technical information about both of these is widely available in the open literature. Much of the technical information about heatshields resulted from nonmilitary research, particularly research related to spacecraft. Although the calculations we perform in this study are not highly detailed, information for considerably more detailed analyses than we do here is readily available.

The level of technology required to develop submunitions is simpler than that required to build long-range ballistic missiles. So if a country has developed long-range missiles, it could also develop submunitions.⁸ If a country received foreign technology and/or expertise to assist its missile program, it is likely that foreign assistance would also be available to develop submunitions to deploy on the missiles. Even if a country simply purchased its ballistic missiles, it would also be able to purchase submunition technology, since a country willing and able to sell long-range missiles would presumably also be willing and able to sell submunition technology for those missiles.⁹

Indeed, the 1998 report of the Rumsfeld Commission stated

All of the nations whose programs we examined that are developing long-range ballistic missiles have the option to arm these, as well as their shorter range systems, with biological or chemical weapons. These weapons can take the form of bomblets as well as a single, large warhead.¹⁰

⁵ Stockholm International Peace Research Center (SIPRI), *The Problem of Chemical and Biological Warfare, Volume I: The Rise of CB Weapons* (New York: Humanities Press, 1973), pp. 106–107.

⁶ Executive Summary, *Report of the Commission to Assess the Ballistic Missile Threat to the United States (Rumsfeld Commission Report)*, 15 July 1998, and National Intelligence Council, “Foreign Missile Developments and the Ballistic Missile Threat to the United States Through 2015,” September 1999. Both discuss the limited testing programs of emerging missile states.

⁷ A less commonly discussed advantage of using bomblets is that a combination of different agents could be used in an attack—for example, fast-acting agents and persistent agents—by putting different agents in different bomblets. (“A New Generation of CB Munitions,” *Jane’s Defence Weekly*, 3 April 1988, p. 852.)

⁸ In its January 1996 report about theater missile defense, the Defense Science Board concluded that the United States must expect emerging missile states to deploy “advanced” submunitions for chemical and biological weapons on their theater missiles, and noted that its own “red team” effort had designed, built, and flown versions of such submunitions (*Report of the Defense Science Board/Defense Policy Board Task Force on Theater Missile Defense*, January 1996, pp. 14, 16).

⁹ The Soviet Union was reported in the late 1980s to be developing new types of chemical and biological submunitions for a variety of delivery systems, including short-range ballistic missiles. (“A New Generation of CB Munitions.”)

¹⁰ *Rumsfeld Commission Report*, p. 7.

US Programs for Delivery of Chemical and Biological Weapons

Early in its development of chemical and biological weapons in the 1940s and 1950s, the United States recognized that using unitary warheads for delivery would oversaturate a small region with the agent and that winds would subsequently spread the agent in only a narrow plume. That led the United States to research ways to disperse the agent more effectively and, in turn, to develop submunitions.^a

In fact, the United States developed chemical and biological submunitions for several of its short-range missiles and for B47 and B52 aircraft in the 1950s and 1960s.^b These bomblets were small, carried small amounts of agent, and had simple dispersion mechanisms to spread the agent once the bomblet was at or near the ground. For example, the M139 bomblet was an 11.4-centimeter-diameter sphere that carried 0.6 kg of GB nerve agent or liquid biological agents. It entered the US inventory in the early 1960s and was used

^a See, for example, Dorothy L. Miller, "History of Air Force Participation in Biological Warfare Program 1944-1951," Historical Study 194, Wright-Patterson Air Force Base, September 1952, p. 81.

^b These short-range missiles were designed to release the bomblets late in flight rather than soon after boost phase. For information on these bomblets see Stockholm International Peace Research Center (SIPRI), *The Problem of Chemical and Biological Warfare, Volume II: CB Weapons Today* (New York: Humanities Press, 1973), p. 84, and Sherman L. Davis, "GB Warheads for Army Ballistic Missiles: 1950-1966," Historical Monograph AMC 51M, Edgewood Arsenal, Maryland, July 1968.

on several short-range missiles: Little John (16 km range), Honest John (38 km range), and Sergeant (140 km range). It disseminated the agent on impact with an explosive charge and was reported to have an 86 percent agent dissemination when used with the Honest John.

The M143 bomblet was a 8.6-centimeter-diameter spherical bomblet designed to carry liquid biological agents. It used 0.5 grams of explosive charge to disseminate the agent on impact. It was said to release 8 percent of the slurry as inhalable aerosol. This bomblet had a mass of only 0.34 kilograms when filled with 190 milliliters of slurry containing about 6×10^{12} anthrax spores. It entered the US inventory in the mid-1960s and 750 such bomblets were carried in the M210 warhead on the Sergeant missile.

The United States also developed other methods to release and disseminate agents. The E95 bomblet was a 7.6-centimeter-diameter sphere designed to carry dry biological agent for anti-crop use, delivered by plane or missile. It was designed to burst open in midair to disseminate the agent over a large area. The E120 bomblet, a 11.4-centimeter-diameter sphere being developed in the early 1960s, carried 0.1 kg of liquid biological agent. Vanes on the outside of the casing caused it to rotate as it fell, so that it would shatter and roll around on impact, spraying the agent from a nozzle.

Note that all of these bomblets are small enough to fit inside the heatshield in the 20-centimeter-diameter spherical configuration considered in this chapter.

Moreover, according to a 1995 news report in *Aviation Week and Space Technology*,

US intelligence officials are predicting the capability to release submunitions from ascending ballistic missiles could be on the world market within five years. They believe that China and North Korea will have the capability to build fractionated warheads. Such weapons could dispense up to 100 5–10 lb submunitions at altitudes of 36 mi [60 km] or less. ... US planners here are worried that China or North Korea will produce and sell the weapons to military powers such as Iran, Syria, Iraq or Libya.¹¹

A number of countries have developed submuni-

tions for short-range missiles. Iraq apparently developed and deployed submunitions to deliver chemical weapons on its Scud missiles prior to the 1991 Gulf War. According to a Pentagon official, following the war UN inspectors found that Iraq had "designed and prepared for firing" a chemical warhead for a Scud missile, "which basically consisted of a bunch of little containers." The official also stated that developing a mechanism for dispersing such bomblets early in a missile's flight would not be difficult for North Korea, China, and Iran, either.¹² The dispersal mechanism for long-range missiles could be quite similar to that for shorter range missiles.

In addition, North Korea is believed to have devel-

¹¹ *Aviation Week and Space Technology*, 24 July 1995, p. 19.

¹² *Aviation Week and Space Technology*, 29 April 1996, p. 23.

oped submunitions for its 300- and 500-kilometer-range Scud missiles. And the Ballistic Missile Defense Organization said in 1997 that Syria was only months away from producing chemical bomblets for its 500-kilometer-range Scud-C missiles.¹³

The Design, Construction, and Use of Submunitions: Key Technical Issues. In this section we consider the key technical issues a country would face in building and deploying submunitions to determine how difficult it would be to use this means of delivery. These issues are (1) how to dispense the bomblets after burn-out and (2) how to design a heatshield for the submunitions so they will withstand the heat of reentry. We also briefly discuss the issue of dispersing the agent from the bomblet. Consistent with the conclusion of the Rumsfeld Commission quoted above, we find that these issues would not be difficult for an emerging missile state to address.

For our analysis, we assume that the ballistic missile used to deliver the attack can carry a payload of 1,000 kilograms or more a distance of 10,000 kilometers. The payload would consist of a large number of bomblets and a dispensing mechanism.

A missile of this range would burn out at an altitude of 200–300 kilometers—well above the atmosphere. At launch, a shroud would cover the bomblets to protect them from atmospheric heating. The missile would drop this shroud before burnout, once it was at a high enough altitude. (North Korea has demonstrated its ability to perform this step, since it successfully released a shroud that covered the third stage of its Taepo-dong-1 missile during its launch in August 1998.)

Shortly after the booster burns out, the warhead section would release the bomblets, kicking each one out with a slightly different speed so that while travelling to the target they would spread out in a cloud of predetermined size. We discuss below two ways this could be done. Note, however, that developing a dispersing mechanism is not demanding on the scale of the technology required to build a long-range ballistic missile. Moreover, a dispersing mechanism could be extensively tested on the ground and would not require flight testing.

The bomblets would then fall through the vacuum of space for about 25 minutes. They would begin to reenter the atmosphere at a speed of roughly 7 kilometers per second, but atmospheric drag would slow them

down so that they would hit the ground with speeds of 75–150 meters per second. As we show below, it is straightforward to develop a heatshield to protect the agent within the bomblet from the high temperatures that occur during reentry.

The final step in the flight of the bomblet is to disperse the agent in the bomblet when it is at or near the ground. As we discuss below, methods for dispersing the agent are well known.

For our analysis, we assume that each bomblet has a total mass of 10 kilograms and carries up to a few kilograms of CB materials. The dispensing mechanism will add perhaps 50–100 kilograms and the shroud roughly 50 kilograms to the payload,¹⁴ allowing 85–90 submunitions of this size and mass to be deployed on a missile capable of carrying 1,000 kilograms. Our estimate below of heatshield requirements, along with the sizes of the US bomblets discussed in the above box, suggests that the bomblets could be made smaller and lighter than we assume here, which would allow the missile to carry more.

In this analysis, we consider submunitions of two shapes: a sphere with a diameter of 20 centimeters (roughly soccer-ball sized), and a cone with a length of 20 centimeters and a nose radius of 5 centimeters (see Figure 7-1).¹⁵

There would be sufficient room in the payload section of a long-range missile for at least 100 bomblets and the dispensing mechanism. Even if the last stage of the missile were as small as the North Korean Nodong missile, with a diameter of 1.3 meters,¹⁶ a cylindrical payload section 1.5 meters long, capped by a conical section one meter long, would have a volume of two and a half cubic meters.¹⁷ One hundred bomblets would

¹³ Paul Beaver, "Syria to Make Chemical Bomblets for 'Scud Cs'," *Jane's Defence Weekly*, 3 September 1997, p. 3.

¹⁴ Assuming the shroud is a cylinder 1.3 m in diameter and 1.5 m long, capped by a conical nose section 1 m long, it would have a surface area of about 9 m². If the shroud is made of aluminum alloy (with a density of roughly 2,800 kg/m³ and has an average thickness of 2 mm, then the mass would be roughly 50 kg. Note, however, the shroud can be dropped well before the end of boost phase, so that the upper stage of the missile does not have to accelerate this mass. As a result, the amount by which the mass of the shroud reduces the payload that could be devoted to bomblets would be considerably less than 50 kg.

¹⁵ This shape was used for calculating the heating of the cone, but there is no special significance to these particular dimensions. The shape could be varied to improve the aerodynamic stability of the cone, for example.

¹⁶ Some people assume that the Nodong missile will serve as the second stage of North Korea's long-range Taepo-dong 2 missile.

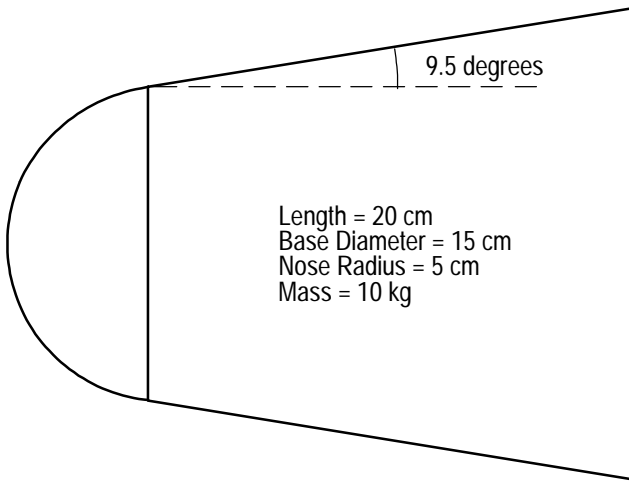

Figure 7-1. The configuration used for calculating the heating of a conical bomblet. It has a nose radius of 5 cm, a base diameter of 15 cm, a length of 20 cm, a cone half-angle of 9.5 degrees, a mass of 10 kg, and a ballistic coefficient of 12,000 N/m² (250 lb/ft²).

occupy only a third of this volume, leaving plenty of room for the dispensing mechanism.¹⁸

Details of Dispensing Bomblets. It is useful to compare the trajectories of the bomblets with the trajectory that a unitary warhead would follow if launched by the same missile. The dispenser that releases the bomblets would follow roughly the same trajectory as a unitary warhead; this trajectory lies in a vertical plane containing the launch site and the point on the ground where the dispenser would impact (see Figure 7-2.)

The warhead section of the missile, including the dispenser and all the submunitions, will be travelling at a speed of roughly 7 kilometers per second when the bomblets are dispensed. Consider what happens if a bomblet is released with a push that gives it a small speed with respect to the dispenser in some direction. There are three directions to consider:

- (1) If the bomblet is given a speed perpendicular to the plane of the trajectory, it will drift in that direction until impact. The greater the speed the bomblet is given, the farther it will travel from its original impact point. Making the bomblet land

¹⁷ On the Taepo-dong 1 missile that North Korea launched in August 1998, the shroud enclosed a cylindrical payload section that housed the third stage of the missile.

¹⁸ If we estimate the volume that a spherical bomblet would occupy (including the space between bomblets) by a cube with sides of length 20 centimeters, then 100 such bomblets would occupy a volume of only 0.8 cubic meters.

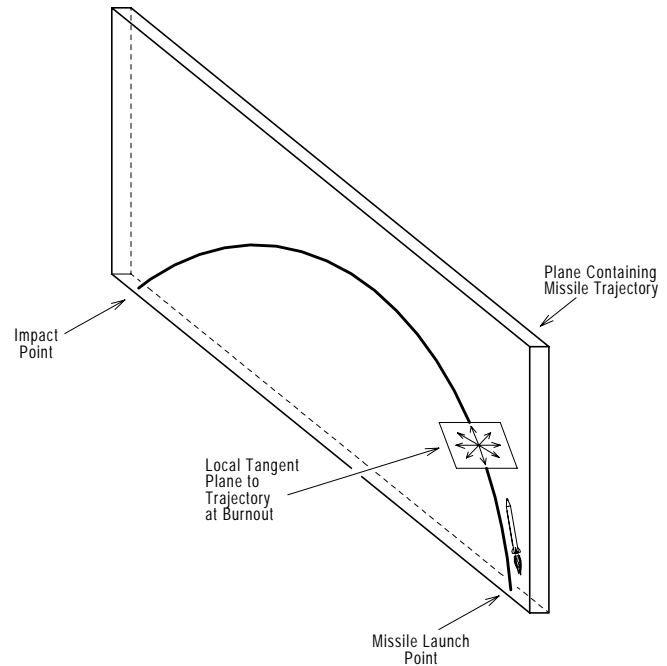

Figure 7-2. The trajectory a bomblet would have if it was given no additional δv after burnout of the missile. The tangent plane to the trajectory at burnout is also shown. Giving the bomblets small velocity changes δv by adding velocity vectors lying in this plane will spread the impact points of the bomblets around the $\delta v=0$ impact point.

10 kilometers from the original impact point after a flight time of 25–30 minutes would require giving the bomblet a small speed of 5.5–6.5 meters per second (12–15 miles per hour) relative to the dispenser.¹⁹

- (2) Giving the bomblet a push in the plane of the trajectory and in a direction tangent to the trajectory is equivalent to changing the burnout speed of the bomblet relative to the dispenser. Thus the trajectory of the bomblet will lie in the plane of the original trajectory but will have a slightly longer or shorter range. A speed of 2–5 meters per second (5–10 miles per hour) would change the range by 10–30 kilometers.²⁰

¹⁹ If δv is the additional speed imparted to the bomblet by the dispenser, the bomblet will land roughly a distance $\delta v \times t$ from the impact point it would have if δv were zero, in a direction perpendicular to the plane of the original trajectory, where t is the flight time after the bomblet is released. Spinning of the bomblets could affect their dispersion; this could be compensated by adjusting the speed of release.

²⁰ This is easily verified using the standard “hit equation” governing missile dynamics.

- (3) Giving the bomblet a push in the plane of the trajectory but perpendicular to the trajectory changes the impact point of the bomblet very little, if the missile is on a standard maximum-range (“minimum-energy”) trajectory.²¹

Thus, to spread out the impact points of the bomblets over a large area of roughly 10–20 kilometers diameter, the dispenser would give the bomblets different speeds (ranging from zero to a few meters per second) in directions lying in the local tangent plane of the trajectory. This can be done in several ways.

A particularly simple method of dispersing the bomblets would be to use springs to give the bomblets the required speeds. Consider a set of tubes having diameters just larger than that of the bomblets, lying in a plane, with each tube pointing in a slightly different direction in that plane (differing by perhaps 10 degrees). One could arrange a stack of such planar layers of tubes such that all the layers were parallel to the tangent plane of the trajectory; this orientation could be controlled by the guidance system of the missile during boost phase. The tubes in each layer would point in a different set of directions from those in other planes. Inside the tubes would be a line of bomblets with compressed springs between them. The number of layers and the number of bomblets in each tube would be determined by the size of the payload section of the missile.²²

When the bomblets were released, they would shoot out of the tubes with a range of speeds determined by the stiffness of the springs, and in exactly the directions that would result in a dispersed set of impact points since the tubes would lie in the tangent plane to the trajectory. The shape of the impact pattern could be controlled by proper choice of the spring constants; springs of different stiffness (i.e., with different spring constants) could be used in the sets of tubes lying in different directions. (However, it would not be necessary for the attacker to carefully control the impact pattern.)

A second method of dispersing the bomblets would be to arrange the bomblets in a cylindrically

symmetric pattern around the axis of the dispenser, which originally would be aligned with the axis of the missile and would thus lie along the direction of the velocity. After burnout, small thrusters would rotate the axis of the dispenser in the plane of the trajectory so that the axis was no longer aligned with the velocity. Another set of small thrusters would then be used to cause the dispenser to spin around its axis. Such thrusters are standard technology for missiles.

Each bomblet would be attached to the dispenser by a wire that would be released once the dispenser was spinning. In this way, the dispenser would release the bomblets in many different directions in the plane perpendicular to the rotation axis. Moreover, the speed of each bomblet would be different and would depend on how far the bomblet is sitting from the axis of dispenser.²³ To give the bomblets the range of speeds that are needed to disperse them over an area with a width and length of 20 kilometers, the dispenser would only have to spin at a rate comparable to the rate at which warheads are typically spun after burnout to stabilize them during reentry: a bomblet released at a distance of 1 meter from the rotation axis would require a spin rate of less than one revolution per second to give it a speed of 5 meters per second.

One could control the shape of the impact pattern of the bomblets by controlling the angle through which the dispenser was rotated before it was spun, but even without controlling this angle precisely, this method would result in a dispersed pattern at impact.

Details of Heat Shielding of Bomblets During Reentry. A key difference between the bomblets designed for short-range missiles and those designed for long-range missiles is that in the latter case, a substantial heatshield would be required to protect the agent from the much higher levels of heat generated during the high-speed reentry through the atmosphere.

It is important to keep in mind that calculations show that a nuclear weapon delivered by long-range missile would experience higher heat loadings than a bomblet (see Appendix F for calculations of the heating on various reentering bodies). Thus, if an emerging missile state poses a threat of nuclear attack by long-range missile, it has mastered a level of heatshield technology that is adequate for bomblets.

²¹ A push in this direction essentially results in a small rotation of the burnout velocity of the bomblet within the plane of the trajectory. But on a maximum-range trajectory, the range varies only to second order in a change in the angle of the burnout velocity.

²² If the tubes point only in directions within 90 degrees of the missile's velocity, then the dispenser could remain attached to the upper stage of the missile, which would make it easier to maintain its orientation until the bomblets were released.

²³ The speed δv of a particular bomblet would be $r \times \omega$, where r is the distance the bomblet is sitting from the axis of rotation and ω is the angular speed of rotation of the dispenser.

One might think that bomblets require more demanding heatshield technology because (1) they are slowed in the atmosphere more than nuclear reentry vehicles and therefore take longer to reach the ground, so that the heat has longer to conduct to the interior of the bomblet, or because (2) chemical and biological agents are extremely sensitive to heat. We show below that neither of these is a problem.

How sensitive are CB agents to heat? As Table 7-1 shows, many of the common chemical and biological agents are not highly heat sensitive: they can survive much longer than the several minutes of reentry time at temperatures greater than room temperature (300 K).

Table 7-1. Stability of common CB agents to heat exposure.

Agent	Half-life at a Given Temperature
Biological Agents	
Anthrax spores	4.5 hours @ 373 K (100° C)
Chemical Agents	
Sarin (GB)	2.5 hours @ 423 K (150° C)
Soman (GD)	4 hours @ 403 K (130° C)
VX	36 hours @ 423 K (150° C)

Source: Sidney Graybeal and Patricia McFate, GPALs and Foreign Space Launch Vehicle Capabilities, *Science Applications International Corporation (SAIC) Report, February 1992.*

The bomblets reenter the atmosphere at about 7 kilometers per second and are slowed by atmospheric drag. In the process, the original kinetic energy of the bomblet is converted to heat in the air around the bomblet, and some fraction of this heat is transferred to the bomblet itself. Two factors must be considered in designing a heatshield for the bomblet: the heating rate at the surface of the bomblet and the length of time the heat has to diffuse into the interior of the bomblet. For bomblets that slow down relatively quickly as they fall through the atmosphere, there will be a longer time for the heat that has been absorbed by the bomblet to diffuse into the interior (this process is known as “heat soak”).

As noted above, we consider two types of bomblets. The first is a sphere with a total mass of 10 kilograms and a diameter of 20 centimeters. This bomblet could be made to spin on reentry to spread the heating out over its surface. The second is a conical bomblet with a length of 20 centimeters and a nose radius of 5 centimeters, again with a mass of about 10 kilograms. This design has the advantage that it falls faster, so that

the heat-soak time is shorter. It also lends itself to a simple fusing and dissemination method, since it can be oriented aerodynamically so that it hits the ground nose-first, which allows a disseminating charge to blow the agent out the back of the cone.

We find that it is straightforward to produce adequate heatshields for these designs that are consistent with the size and mass of these bomblets. Indeed, it appears that the bomblets could be made smaller and lighter than we consider here, which would allow more to be delivered on a given missile.

For this study, we have only considered relatively simple heatshield materials that were developed 30–40 years ago. Not only are these materials relatively simple, but considerable information about them is available to anyone, including an emerging missile state. However, considerably more advanced materials are in common use today and are commercially available.²⁴

The primary heatshield material we consider is silica phenolic or “refrasil phenolic,” which is roughly 35 percent by weight phenolic resin impregnated into a fabric reinforced with high-purity glass fiber. Heatshield materials based on phenolic resins were considered state of the art in the 1960s because of their thermal, mechanical, and chemical properties. These materials reduce the heat transferred through them by ablating the outer surface away.

For the spherical bomblet with a heatshield made of silica phenolic, the thickness of material ablated from the surface is only about 3 millimeters. (See Appendix F for details of the heating and ablation calculations.) In addition, a shell of this material that is 2 centimeters thick will keep the temperature increase at the inside of the heatshield to less than 50° C by the time it hits the ground, and a 2.5-centimeters-thick shell will keep the temperature rise to less than 20° C. For a bomblet with a diameter of 20 centimeters, a shell of this material with a thickness of 2 or 2.5 centimeters would have a mass of 3.3 or 4.0 kilograms, respectively.

We also consider other standard heatshield materials of the same vintage as silica phenolic. For example, by using nylon phenolic, which has a low density

²⁴ As one example, there is a material called Thermasorb, in which heat is absorbed with no rise in temperature by a phase transition in a material that could be used to fill a thin shell at the inner edge of heatshield (see www.thermasorb.com).

relative to silica phenolic, a greater volume of material will be ablated but a lighter heatshield can be used. Using nylon phenolic for the spherical bomblet would result in a surface ablation of about 9 millimeters, but restricting the temperature rise at the inner surface of the heatshield to 20° C would require the original thickness of the heatshield to be only 2 centimeters. A 2-centimeter-thick shell of this material would only have a mass of 1.2 kilograms, compared with the 4 kilograms needed for a silica phenolic heatshield that restricts the temperature rise to 20° C.

In practice, other simple things would improve the design and reduce mass. For example, it would make sense to use a thinner shell of ablating material and back it with a lightweight layer of highly insulating material. In addition, if the bomblet had a metallic shell for structure inside the heatshield, the metal would act as a heat sink and could reduce the amount of heatshield required.

For the conical bomblet using the same silica heatshield material considered above, about 1 centimeter of material would be ablated at the nose, where the heating is most severe, and about 3 millimeters of material would be ablated at a point on the wall a distance of 10 centimeters behind the nose. The calculations show that at the nose a thickness of less than 3 centimeters of material is required to keep the temperature rise at the back of the heatshield to roughly 20° C. On the side walls of the bomblet, 2 centimeters of material would keep the temperature rise at the inside surface of the heatshield to less than roughly 20° C, and 1.5 centimeters of material would result in a temperature rise of 70° C. A conical heatshield that had 5 centimeters of material at the nose and 1.5 to 2 centimeters of shielding on the walls would have a mass of about 1.7 to 2 kilograms. And, as above, in practice a country could do things to make the heatshield thinner and lighter than this.

These calculations demonstrate that effective, lightweight heatshields can easily be made for bomblets using even simple materials developed decades ago. Thus, even if a spherical or a conical bomblet of this shape were not used, it is clear that an adequate heatshield could be developed for a different design.

Heating or Cooling of the Bomblets During Midcourse. There seems to be a common misperception that the temperature of bomblets would drop dramatically during their roughly 25-minute flight between release from the missile and the beginning of atmospheric reentry and that this could harm the CB agent contained in the bomblet. As shown in Appendix A, if

the bomblet is in the sunlight its temperature can either increase or decrease from an initial temperature of 300 K (room temperature), depending on the surface coating of the bomblet. Thus the attacker can easily design the bomblet so that its equilibrium temperature will be close to 300 K.

If the bomblet is in the dark, its temperature will drop, but will do so only slowly as it radiates away heat. Appendix F considers the case of the 10 centimeter-radius spherical bomblet with a 2-centimeter-thick heatshield made of silica phenolic. The appendix shows that if the bomblet were in the dark along its entire trajectory, after 30 minutes the temperature of the bomblet would drop by less than 20 K from its initial temperature of 300 K. So in neither case would the temperature change of the bomblet during the midcourse phase present a problem for the chemical or biological agent.

Releasing the Agent. The final step in delivery is to release the chemical or biological agent from the bomblet and disperse it. Of course, this would also need to be done for CB agents deployed in a unitary warhead, so if a country has weaponized these agents, it could apply these techniques to bomblets.

Several methods of fusing have been discussed in the open literature, including contact fuses that would detonate upon hitting the ground and barometric fuses that would release the agent at a preset altitude.²⁵ Note that at low altitudes, the speed of the bomblets would be very low: the spherical bomblet would impact the ground at 75 meters per second and the conical bomblet at 150 meters per second, corresponding to 170–340 miles per hour. These speeds, which are typical of aircraft, make dispersal easier than do very high speeds. Given these speeds, it would even seem possible to use a small sprayer to release the agent. This could be very efficient because sprayers can release the agent in the droplet sizes that are optimal for infecting people.

For the conical bomblet, an easy fusing method would be to have a contact fuse in the nose of the bomblet, which would ignite a dispersing charge when the nose hit the ground that would blow the agent upwards into a cloud. Designs for this type of dispersion mechanism have been around for 40 years.

²⁵ SIPRI, *CB Weapons Today*, for example, references a number of US patents granted in the 1950s and 1960s for fusing and dispersal mechanisms, which give detailed descriptions and technical diagrams.

Because bomblets on a long-range missile undergo severe deceleration in the atmosphere, bomblets released from a 500-kilometer range missile like the Syrian or North Korean Scud-C, would have the same range of speeds at low altitudes as would these bomblets on long-range missiles.²⁶ As a result, the dispersal mechanisms developed for bomblets on short-range missiles could also be used for bomblets on long-range missiles.

Finally, it is important to note that because of the low speeds and altitudes the bomblets would have at release, dissemination of chemical or biological agents could be tested by dropping small bomblets containing simulated agents from aircraft. In this way, clandestine tests can be done to achieve the optimal particle size.

²⁶ The braking force on a body in the atmosphere is proportional to the square of its speed. Thus the faster bomblets on a long-range missile will experience much stronger braking forces than slower bomblets. Bomblets having the same ballistic coefficients as those considered above released from a 500-km-range missile would have speeds of 90 to 150 m/s at impact.

Chapter 8

Emerging Missile State Countermeasure 2: Anti-Simulation Balloon Decoys for Nuclear Warheads

According to the September 1999 National Intelligence Estimate on the Ballistic Missile Threat to the United States, balloon decoys are a “readily available technology” that emerging missile states could use to develop countermeasures to the US NMD system.

In fact, the first two intercept tests of the NMD system included one balloon decoy along with the mock warhead. This test configuration, together with statements that it is representative of the threat, indicates that even the Ballistic Missile Defense Organization believes that such balloons are within the technical capability of an emerging missile state. In this chapter, we consider a countermeasure that would be only slightly more difficult to implement because it uses numerous such balloons, but would be much more effective against the planned NMD system because it also puts the warhead in a balloon. Of course, making and deploying such balloons would be technically much simpler than building and deploying a long-range missile and a nuclear warhead, which is the level of technology the United States assumes an attacker would have.

We conclude that an attacker seeking to deliver a nuclear warhead by a long-range ballistic missile could defeat the planned NMD system by enclosing the warhead in a metal-coated balloon that is inflated in space when the warhead is deployed, while at the same time releasing large numbers of similar, but empty, balloons. The attacker could prevent the planned NMD system from being able to discriminate the balloon containing the warhead and thus prevent the defense from reliably hitting the warhead.

The balloons could be either free-flying or tethered together. Above the atmosphere, where the attacker would use anti-simulation to make the warhead look like a balloon decoy, objects of different weights would

follow the same trajectory. The thin metal coating of the balloon would prevent radar waves from penetrating the balloons to determine which contained a warhead.

The balloons could be identical in size and shape, or they could be designed so that each one was different from the others. They could be spherical or irregular in shape. In addition, the temperature of the balloons could be easily manipulated so that each one was at a different temperature (over a range of temperatures plausible for the balloon containing the warhead) to prevent the NMD system’s heat-detecting infrared sensors from being able to determine if a balloon contained a warhead.

As we describe below, for attacks on daytime trajectories (i.e., those in sunlight), an attacker could set the temperature of each balloon anywhere in a span of several hundred degrees centigrade simply by choosing the appropriate surface coating. By choosing surface coatings that would produce balloon temperatures near the initial temperature of the nuclear warhead, the attacker would essentially eliminate any thermal effect that a nuclear warhead would have on its balloon. Thus, if the warhead were initially near room temperature (300 K), the attacker could paint the balloons so that their temperatures would vary slightly around 300 K. In this way, the attacker would prevent all of the NMD infrared sensors—those on the SBIRS-low satellites and those on the kill vehicle—from discriminating the balloon with the nuclear warhead from the empty ones.

For attacks on nighttime trajectories (i.e., those in the earth’s shadow), the balloons would all cool to a low temperature. The temperature of the balloons would not depend on their surface coating, but only on their shape. If all the balloons had the same shape, the empty balloons would cool to a somewhat lower temperature

(of about 180 K, or -93 degrees Celsius, for spherical balloons) than would the balloon containing the warhead. To prevent the infrared sensors from discriminating the warhead, the attacker could use small battery-powered heaters to bring the temperature of the empty balloons up to that of the balloon with the warhead. Alternatively, the attacker could use entirely passive means to mask the presence of the warhead. First, to reduce the heat transfer from the warhead to the balloon, the attacker could cover the nuclear warhead with superinsulation or a low-emissivity coating such as shiny aluminum foil or polished silver. Then the attacker could use balloons of different shapes, so that all the balloons would have different equilibrium temperatures that varied over a range of a few degrees. One of these balloons would contain a nuclear warhead but again, none of the NMD infrared sensors—those on the SBIRS-low satellites and those on the kill vehicle—would be able to discriminate the balloon with the nuclear warhead from the empty ones.

The attacker could also design balloons that would be effective regardless of whether the trajectory was in sunlight, or earth's shadow, or some of each. For example, the balloons could be of different shapes and have a surface coating that would give an equilibrium temperature near room temperature in the sunlight. If the attacker then covered the warhead with superinsulation or a low-emissivity coating, each balloon would have slightly different equilibrium temperature. Thus, the NMD infrared sensors could not discriminate the balloon containing the warhead from the empty ones on any trajectory, regardless of how much of it was in sunlight or the earth's shadow.

The NMD system would also attempt to discriminate the empty balloons from the balloon containing the warhead by using its X-band radars to observe any mechanical interaction between the nuclear warhead and its balloon. However, the attacker could also readily prevent such discrimination. If the attacker attached the warhead to its balloon using strings or spacers of the appropriate length, the balloon would move along with the warhead, whether or not the warhead was tumbling or spinning. The attacker could also make the empty balloons tumble and spin. And the attacker could use a similar string structure inside the empty balloons, so that all the balloons would have similar surface features where the strings were attached.

Thus, by placing a nuclear warhead in a balloon and releasing it with other empty balloons, an emerging missile state would prevent the planned NMD

system from being able to discriminate the balloon containing the warhead in midcourse.

The NMD system would then be confronted with a large number of potential targets, no two of which were identical in appearance, and any one of which could contain a warhead. Thus, to permit a midcourse intercept, the NMD system would either have to fire interceptors at all of the balloons or risk letting the balloon containing the warhead go unchallenged. Because the number of balloons deployed per missile could be large—up to 50 or more—the use of this countermeasure would quickly exhaust the NMD's supply of interceptors. The NMD system is intended to defend against an emerging missile state with tens of missiles; yet a state using only, say, five missiles could deploy one or more nuclear warheads in balloons and hundreds of empty balloons in an attack on a US city.

Although the NMD system is designed to intercept in midcourse, the defense could—as a last-ditch effort—attempt an intercept after the warhead and decoys begin to reenter the atmosphere, where air resistance would slow the lightweight balloon decoys relative to the heavier balloon containing the warhead. Unless the attacker took steps to prevent it, the X-band radars would be able to make very accurate velocity measurements using the Doppler shifts of the radar waves reflected from an object. At altitudes low enough that the velocity difference between light decoys and the heavy warhead could be measured, the radars would then be able to discriminate the balloon with the warhead from the other balloons. To implement this strategy, the defense would need to launch several interceptors at a predicted intercept point just above the minimum intercept altitude of the kill vehicle. However, to have enough time to reach the intercept point, the defense would need to launch these interceptors well before the balloons begin to reenter the atmosphere and then divert them in mid-flight if the X-band radars were able to discriminate the balloon with the warhead from the other ones.

This would present the defense with a significant problem because it would have to decide how many interceptors to launch before it knew how many of the balloons it could discriminate. If the defense was planning to discriminate during reentry and saw dozens of balloons deployed from each missile, it would need to assume that some of these balloons would be heavy enough to prevent discrimination above the kill vehicle's minimum intercept altitude. To achieve the high effectiveness and confidence levels planned for

it, the defense would need to fire a large number of interceptors at the balloons deployed by each attacking missile. Thus, for an attack of tens of missiles, the defense would still be in the position of choosing between letting the warhead penetrate unchallenged or running out of interceptors.

Moreover, as we discuss in detail below, the attacker could take various steps to further complicate the job of the defense by lowering the altitude at which the X-band radars could discriminate a balloon containing a warhead from the other balloons. And, even if the X-band radars could determine in time which balloon in a cluster of numerous closely-spaced balloons contained a warhead, it may not be able to convey this information to the kill vehicle in a useful fashion. The ability of the radars to determine the angular position of the balloons (as distinct from their range) is somewhat limited. Thus, if the balloons are spaced closely together, the NMD system may be unable to pass an accurate enough map to the kill vehicle to allow it to home on the target using its own sensors.

We thus conclude that an attacker could prevent the planned NMD system from intercepting its nuclear warhead with high confidence by using anti-simulation balloon decoys.

As we discuss in more detail below, such balloon decoys would be easy to fabricate and deploy relative to building an intercontinental ballistic missile or a nuclear weapon. In fact, in the late 1950s the United States designed and built small metal-coated balloons to measure the density of the atmosphere, and placed several of these balloons into orbit in the 1960s. These balloons, which were 3.7 meters in diameter, are quite similar to ones that could be used as a missile defense countermeasure. (See Figure 8-1.) Detailed information on the design, construction, and deployment of these balloons has been publicly available for over thirty years; some of this information is provided in Appendix G on the NASA Air Density Explorer series of inflatable balloon satellites.

In the rest of this chapter we first discuss how such balloon decoys could be built. We then consider in detail how the attacker could prevent the NMD system from using any of its sensors to discriminate a balloon containing a warhead from empty balloons in mid-course, where the system is designed to intercept its targets. Finally, we discuss several measures the attacker could take to prevent the defense from using atmospheric drag to discriminate the target and then to make a last-minute intercept during reentry.

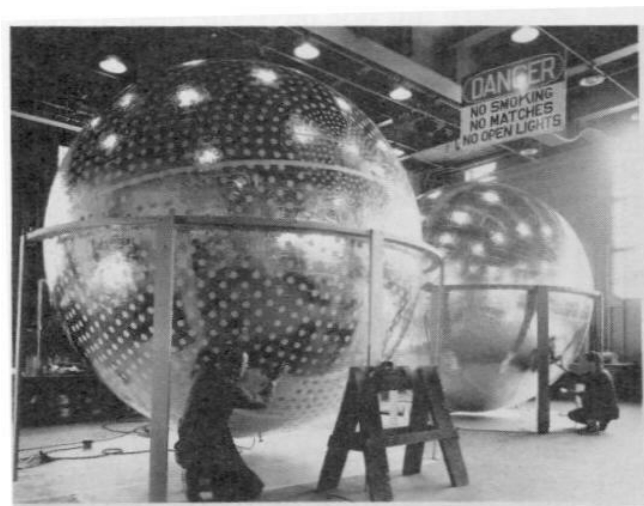

Figure 8-1. A photograph of one of the NASA Air Density Explorer inflatable balloon satellites.

Design, Construction and Deployment of Balloons

The balloon decoys could be built in a way similar to the way in which NASA built its Air Density Explorer balloon satellites. These satellites were made of a laminate¹ of two layers of aluminum foil and two layers of mylar, with the outer layer being aluminum. Each layer was 0.0005 inches thick, for a total thickness of 0.002 inches. The balloon satellites weighed roughly 4.5 kilograms (10 pounds).

An attacker could construct balloon decoys using a two-ply laminate of aluminum foil and mylar (or a mylar-polyethylene composite), with each ply having a thickness of 0.0001 to 0.001 inches. Both of these materials are widely available commercially. In fact, it may not even be necessary to make the laminate: aluminized mylar is commercially available for use in packaging.

To make a spherical balloon, the laminate would be cut into strips and glued together over a hemispherical mold, with the aluminum on the outside. However, there is no need for the balloons to be spherical. Other shapes may be easier to fabricate and fold and, as discussed below, may have other advantages as well.

The air would then be pumped out of the balloon, and the balloon folded into a small volume. (The 3.7-meter-diameter NASA balloons were folded into a cylinder 18 centimeters (7 inches) in diameter and 28 centimeters (11 inches) long.) The balloon that was to contain the warhead could be cut open and resealed once

¹ A laminate is a material made by gluing or otherwise bonding together two or more thin layers.

the warhead was placed inside. The air could then be pumped out of the balloon, causing it to collapse down on the warhead. To keep the warhead positioned within the balloon once it was inflated, the balloon could be attached to the warhead either by several rigid spacers made of a material with low thermal conductivity or by strings. Alternately, the warhead could be left to float within the balloon.

When deployed, the balloons could be inflated in one of several ways. Here we will assume that the balloon is inflated with nitrogen (or another gas) to a pressure of 0.1 pounds per square inch (PSI).² This pressure would be more than adequate to inflate the balloons; it was the pressure used to inflate the NASA balloons. This gas pressure would stress the aluminum foil to its yield strength to give the balloon its maximum structural strength.³ Once the balloon has been stressed to its yield strength, it will be stronger and will also have its wrinkles and folds removed, even if the gas is then vented out. Until the balloon was released and inflated, the nitrogen could be contained in a small steel bottle. After the balloon was inflated, the gas bottle could be made to detach and fall off outside the balloon, as was done for the NASA balloons.

We will consider two balloons that differ from each other in weight. The heavy balloon is spherical in shape, has a diameter of three meters, and is made of a laminate of a 0.001-inch-thick layer of aluminum foil and a 0.001-inch-thick layer of mylar (which gives it the same thickness as the NASA balloons). Balloons of roughly this size and thickness, and the gas used to inflate them, would weigh about 3 kilograms (6.5 pounds).⁴ The dispensing mechanism for each balloon and the bottle the gas is stored in would add to this weight; if we assume the dispenser and bottle are comparable in weight to the balloon and gas, we get a total weight of 6 kilograms for each balloon deployed.

² Another means of inflating the balloons once they are deployed would be using chemical gas generators, like those that are used to inflate automobile airbags.

³ The yield stress is defined to be the applied load at which the stress-strain relationship is no longer linear. In ground tests, the NASA researchers found that by subjecting the balloon to this level of stress, not only was its structural strength increased, but the folds in its surface were smoothed out.

⁴ The volume of this balloon would be 14.1 cubic meters and its surface area 28.3 square meters. Filling a balloon of this size with nitrogen at a pressure of 700 Pa (0.1 PSI) would require roughly 96 liters of nitrogen at standard temperature and pressure (STP), or about 120 grams of nitrogen.

The NASA balloons were designed so that the gas used to inflate them would leak out over a period of several days after their deployment; ground tests of these balloons indicated that without their pressurizing gas they would remain spherical down to an altitude of about 120 kilometers. Because these heavy balloon decoys would be made of a material with the same thickness as the NASA balloons, they would also retain their shape down to about 120 kilometers if the gas was vented out after inflation.⁵

Considerably lighter balloons could be made by using thinner balloon materials. In this way the weight of the balloon, the gas, and the gas bottle could be reduced considerably. For our lightweight balloon model, we assume the material used to construct the balloon consists of a 0.00025-inch-thick mylar layer and a 0.0001-inch-thick aluminum layer. The thinner layer of aluminum will reduce the pressure required to take the aluminum foil to its yield strength, so less gas will be needed to inflate the balloon and a smaller and lighter bottle can be used to hold the gas. The total weight of the balloon, gas, and gas bottle would be about 500 grams (roughly 1 pound).^{6,7} If we again assume the

⁵ The Ballistic Missile Defense Organization has a goal of 130 kilometers for the minimum intercept altitude of the NMD kill vehicle, so the heavy balloon decoys would retain their shape below this altitude.

⁶ For material of this thickness, a balloon with a diameter of three meters would weigh about 440 grams.

The thinner layer of aluminum would reduce the pressure required to take the aluminum foil to its yield strength by a factor of ten. The inflation pressure could thus be reduced to roughly 70 Pa (0.01 PSI), so that only 12 rather than 120 grams of nitrogen gas were needed to inflate the balloon. (The dynamic pressure on the balloon due to reentry would not exceed the inflating pressure of 70 Pa until the balloon reaches an altitude of about 90 km.)

The gas bottle, made of steel, would weigh about 70 grams. If we assume a moderate bottle pressure of 1.4×10^7 Pa (2,000 PSI), the volume of the bottle would have to be about 0.07 liters (or 70 cubic centimeters) to hold the nitrogen. If we assume the bottle is a cylinder of length 8 centimeters, then its inner radius must be about 1.7 centimeters. Assuming a fairly low value of yield strength of 3.0×10^8 Pa (44,000 PSI), a steel bottle (with a density of 7.8 grams per cubic centimeter) would have a wall thickness of 0.085 centimeters and a mass of about 70 grams.

Note that we neglect the weight of the glue used to bond the balloon together.

⁷ Even lighter balloons could be made. The aluminum layer could be made approximately a factor of ten thinner (only 0.00001 inches thick) and still be a good reflector of radar (this thin aluminum layer could be vapor-deposited onto the mylar). A mylar thickness of 0.00025 inches may be near

weight of the dispensing mechanism is roughly that of the balloon, this would give a total weight penalty for each balloon of very roughly 1 kilogram (2 pounds).

If the inflating gas was vented from them, these lightweight balloons would not retain their shape as low into the atmosphere as would the heavier ones. Their deformation would likely begin at an altitude of perhaps 150 to 160 kilometers.⁸ However, they would retain their shape lower into the atmosphere if the gas was not vented.

A simple nuclear weapon would weigh perhaps 1000 kilograms, and it is reasonable to assume that the attacker could use about 10 percent of the payload, or roughly 100 kilograms, for countermeasures. Thus, if the attacker is satisfied with a relatively small number of decoys (15 or less) per missile, then a weight of 6 kilograms per decoy is acceptable, and the heavy balloon decoys could be used. However, if the attacker prefers to use a larger number per missile, then lighter decoys would be needed. It is reasonable to expect that an attacker could deploy as many as 100 of the lightweight (0.5 kilogram) balloon decoys we describe above on a missile along with a nuclear warhead. An emerging missile state with tens of missiles might not have enough nuclear warheads to arm each missile, in which case it could have several missiles whose entire payloads were devoted to balloons of various weights. (The attacker would probably not want to use the entire payload to deploy light balloons because the defense might well conclude that the missile could not carry hundreds of decoys and a warhead. Instead, the attacker would likely choose to deploy perhaps 25 to 50 heavy balloon decoys.)

We also note that the attacker could test the construction and deployment mechanism using clandestine ground tests. The attacker would likely not want to

the practical lower limit for the mylar thickness. Neglecting the weight of glue, this would give a balloon mass of about 280 grams, including the inflating gas, but not the gas bottle. (The designers of NASA's 100-foot-diameter Echo I satellite planned to use 0.00025-inch-thick mylar with a 0.000009-inch-thick layer of vapor-deposited aluminum, but found that to get the required inflation reliability 0.0005-inch-thick mylar was required. However, for the much smaller balloons considered here the 0.00025 mylar thickness would likely be sufficient.) See G.T. Schjedahl Company, "Design and Fabrication of Inflatable and Rigidizable Passive Communications Satellites (Echo I and Echo II)," Conference on Aerospace Expandable Structures, Dayton, Ohio, October 23–25, 1963, pp. 576–604.

⁸ The reentry forces on the balloon would be a factor of ten lower at an altitude of 160 km than they would be at 120 km.

test these balloon decoys by flight testing them since the United States could observe such tests.

How Anti-Simulation Balloon Decoys Would Prevent Midcourse Discrimination

To understand how the balloons would prevent the NMD system from discriminating the balloon containing the warhead from the other balloons during midcourse, it is useful to first consider the "ideal" case: a metal-coated balloon travelling through the vacuum of space where the warhead suspended inside the balloon does not interact with the balloon in any physical way. Compared with an empty but otherwise identical balloon, the appearance of the balloon with the warhead would be exactly the same to radar, infrared, and visible sensors. No sensor planned for use by the NMD system could determine which balloon had the warhead and which did not; discrimination would be impossible.

However, the real world would differ from this ideal case in two ways, either of which could potentially be used by the NMD system to discriminate a balloon containing a warhead from an empty balloon:

- (1) The warhead would interact thermally with the balloon, possibly causing changes in the balloon temperature (either over the whole balloon, or in hot or cold spots), including changing the rate at which the balloon changed temperature after it was released.
- (2) The warhead would interact mechanically with the balloon, possibly causing changes in the shape or motion of the balloon.

Below we consider each of these issues in turn, showing how the attacker could mask these effects to prevent the defense from determining which balloon contains a warhead.

We also note that it would not be possible for the NMD sensors to discriminate a balloon with a warhead from the empty ones during their deployment because at this distance the sensors would be unable to resolve closely-spaced objects, and would therefore not be able to observe the deployment of countermeasures in any detail. As discussed in Appendix B, the resolution of the SBIRS-low infrared sensors would be too poor to allow any imaging of a balloon or warhead-sized object; instead these sensors would see all midcourse objects as point emitters. The early warning radars have even poorer resolution (see Appendix D). Even if an X-band radar was in a position to observe the

deployment, its resolution would also be inadequate to distinguish between the different objects, which would be densely spaced when they are deployed.⁹

Discrimination by Infrared Sensors: The Thermal Effects of the Warhead on the Balloon. As we show in this section, the attacker could completely eliminate any ability the defense might have to discriminate based on infrared data from either SBIRS-low or the kill vehicle’s seeker. We consider daytime and nighttime attacks separately since the thermal behavior of objects in space is different in these two cases. The attacker can choose to fly its missiles on trajectories that are either (entirely or mostly) sunlit or in the earth’s shadow. The attacker can thus choose to design its balloons to be effective against infrared sensors in either regime. Alternatively, it could choose to build balloons that would be effective against IR sensors on both daytime and nighttime attacks, as we discuss below.

Daytime Attacks

The thermal behavior of empty balloons. As discussed in detail in Appendix A, the equilibrium temperature of an object in sunlit space is largely determined by its surface coating. Thus, the attacker can easily vary the equilibrium temperatures of its empty balloons by applying various surface finishes, such as paint. Table 8-1 lists the equilibrium temperature for a sunlit spherical object with different surface coatings: seven paints, two metal finishes, and mylar. The equilibrium temperature varies by more than 300 K, from 227 K for white titanium dioxide paint to 540 K for polished gold plate.

The examples we use in this section are all spherical balloons, because it is more straightforward to calculate the thermal properties of a spherical object than for a nonspherical object. However, we emphasize that the general results are applicable to a balloon of any shape. (We discuss later in this chapter and in more detail in Appendix A the effect of balloon shape on thermal behavior.) This discussion initially assumes that the entire surface of any given balloon will be at a uniform temperature; we will consider temperature variations over the surface of the balloons subsequently.

⁹ Although the X-band radars would have high range resolution, they would have poor angular resolution. Because the objects will be densely spaced when they are deployed, each radar range slice would contain multiple objects, and the radar’s poor angular resolution would make it unable to distinguish between different objects that were at the same range. In addition, there would be screening effects because balloons between the radar and the deployment mechanism would block the radar’s view.

Table 8-1. Equilibrium temperature, for various coatings, of a sphere in sunlight.

If an object in orbit is in sunlight, its surface coating will determine the equilibrium temperature. This equilibrium temperature is listed for a sphere (or spherical shell) coated with each material; it is independent of the size of the sphere. Unless otherwise stated, all objects are assumed to be in low earth orbit, at an altitude of several hundred kilometers. It is also assumed that the spheres are spinning and tumbling in such a way that all parts of their surface are equally exposed to sunlight, although clearly this can only be approximately true. (See Appendix A for details of calculation.)

Surface Coating	Equilibrium Temperature of Sphere in Sunlight (K)
White titanium dioxide paint	227
White epoxy paint	237
White enamel paint	241
Mylar	265
Aluminum silicone paint	299
Grey titanium dioxide paint	307
Black paint	314
Aluminum paint	320
Aluminum foil (shiny side out)	454
Polished gold plate	540

Table 8-1 shows that by painting all or part of the surface of a balloon whose outer layer is aluminum foil with one or several different paints, any equilibrium temperature between 227 K and 454 K can be obtained. (For example, if the aluminum is entirely covered with white titanium dioxide paint, it will have an equilibrium temperature of 227 K. If instead part of its surface is covered with black paint, it will have an equilibrium temperature between 314 K and 454 K, depending on how much of its surface is painted.) Thus, the attacker can choose the equilibrium temperature of each balloon. In fact, NASA used just this approach to control the temperature of its Air Density Explorer Balloons in order to keep the radio beacons inside the balloons within their operating temperature range. The aluminum outer surface of these Air Density Explorer Balloons was partly covered with small circles of white paint to reduce the balloon’s equilibrium temperature.¹⁰ (See Appendix G).

If the initial temperature of a lightweight balloon when it is released is significantly different from its equilibrium temperature (which need not be the case), its temperature would change rapidly, since the heat capacity of such a balloon would be very low. How quickly a balloon comes to its equilibrium temperature depends on how different its initial and equilibrium temperatures are from one another and how great its heat capacity is. As we show in Appendix A, using the lightweight balloon model described above (with a mass of 0.5 kilograms), an empty balloon initially at room temperature (300 K) will reach its equilibrium temperature within about a minute, while the 3-kilogram balloons could require several minutes, depending on their surface coatings.

The thermal behavior of a balloon containing a warhead. How would the presence of a warhead inside a balloon affect its thermal behavior?

The temperature of the massive warhead would change only slightly in the short time between when it is launched and when it reenters the atmosphere, but the much lighter balloon enclosing the warhead would rapidly reach its equilibrium temperature. Because a warhead inside a balloon could be at a different temperature than the balloon, and because the warhead has a much greater heat capacity than the balloon, its presence inside a balloon could affect the thermal behavior of the balloon. If the attacker did not take steps to prevent or mask these effects, there are several ways in which the defense might be able to determine which balloon contained the warhead. These include: the direction of the temperature change of the balloon after its release (i.e., whether the balloon heats or cools); the rate of the temperature change of the balloon (i.e., how quickly it reaches its equilibrium temperature); and its final equilibrium temperature. We show below that the attacker could prevent the NMD system from using any of these thermal effects to discriminate an empty balloon from one containing a warhead.

Direction of temperature change. Assuming that both the warhead and the balloon are at the same temperature when deployed, the presence of a warhead inside a balloon would not cause that balloon to warm up when, if empty, it would have cooled down (or vice versa). The warhead can only pull the temperature of the balloon back towards the initial warhead

temperature. (For example, if the warhead and balloons are initially at room temperature (300 K) when they are released, the warhead will pull the balloon temperature back towards room temperature.) Thus, a balloon with a warhead inside may cool down or heat up more slowly than a similar empty balloon. However, whether a balloon warms or cools after its release does not, by itself, indicate whether the balloon contains a warhead.

Rate of temperature change and equilibrium temperature of balloons. If the warhead and balloon are at different temperatures, the warhead will transfer heat to (or from) the balloon in several ways: by radiation, by conduction through any spacers used to position the warhead within the balloon, by conduction through the gas in the balloon, and by motion-driven convection of the gas. As discussed in more detail in Appendix H, radiation is likely to result in the largest heat transfer. Thermal conduction through any spacers could be made negligible. Conduction through the gas will give rise to a smaller effect than radiation and could be avoided by venting the gas. The effect of convection of the gas could also be avoided by venting the gas.

What is most important is that the rate of heat transfer between the warhead and the balloon will be small compared with the solar power incident on the balloon (which would be about 10,000 watts for a balloon with a diameter of three meters). This would permit the attacker to use balloons that have small differences in how efficiently they absorb solar energy (and radiate infrared energy) to completely obscure the thermal effect of the warhead (see Appendix H).

Although it is possible to hide a warhead in a balloon with any equilibrium temperature, the attacker could essentially eliminate the effect of the warhead on the thermal behavior of the balloon by simply choosing a surface coating that produces a balloon equilibrium temperature close to the initial temperature of the warhead. In this way, there would be only a small temperature difference to drive the heat transfer, and the warhead would produce only a negligible thermal effect for the defense to detect. Thus, if the warhead is initially near room temperature (300 K), the attacker could enclose it in a balloon with a surface coating that produced an equilibrium temperature near 300 K. The attacker would construct the other balloons so that they would have equilibrium temperatures within a narrow range around this temperature. The defense would then see numerous balloons at slightly different temperatures and would have no way of knowing which one contained the warhead.

¹⁰ The first of these 3.7-meter-diameter balloon satellites, Explorer IX, had 17 percent of its surface covered with white paint, and the second, Explorer 19, had 25 percent of its surface covered with white paint.

This approach is illustrated in Figure 8-2. The heavy lines show the temperature variation of several lightweight aluminum balloons (our lightweight balloon model described above with a mass of 0.5 kilograms), covered with varying amounts of white enamel paint. We assume the paint is distributed over the surface of the balloon, perhaps using small circles as was done for the NASA balloons. We also assume the balloons are at room temperature (300 K) when released. As the figure shows, varying the fraction of the balloon surface that is covered by the white paint from 21 to 26 percent would produce a temperature spread slightly greater than 10 K around the initial temperature of 300 K, with the balloons reaching their equilibrium temperatures in less than one minute.

Figure 8-2 also shows the effect of adding a warhead to a balloon (specifically, to the balloons with 21 and 26 percent of their surface covered with white paint).¹¹ We assume the warhead has a low emissivity finish or surface coating, such as aluminum foil (with an emissivity, ϵ , of 0.036), and treat the inside of the balloon as a blackbody. For both balloons, the heat transfer is taken to be five times larger than would actually be produced by a warhead with a surface emissivity of 0.036.¹²

As this figure shows, the effect of the warhead would be to pull the equilibrium temperature of its balloon back towards room temperature, but the shape of the curve is essentially unchanged. The thermal behavior of the balloons containing the warheads would be indistinguishable from that of empty balloons covered with slightly different amounts of white paint. Thus, by using balloons with surfaces designed to produce a small span of temperatures around the warhead temperature, the attacker could easily hide any thermal effect of the warhead.

Alternatively, a spread of temperatures could be obtained by painting the same fraction of each balloon's surface, but using slightly different paints on each balloon. For example, consider using three different types of white paint. A balloon with 25 percent of its surface covered with white enamel paint will have an equilib-

Empty Balloons Partially Covered with White Paint

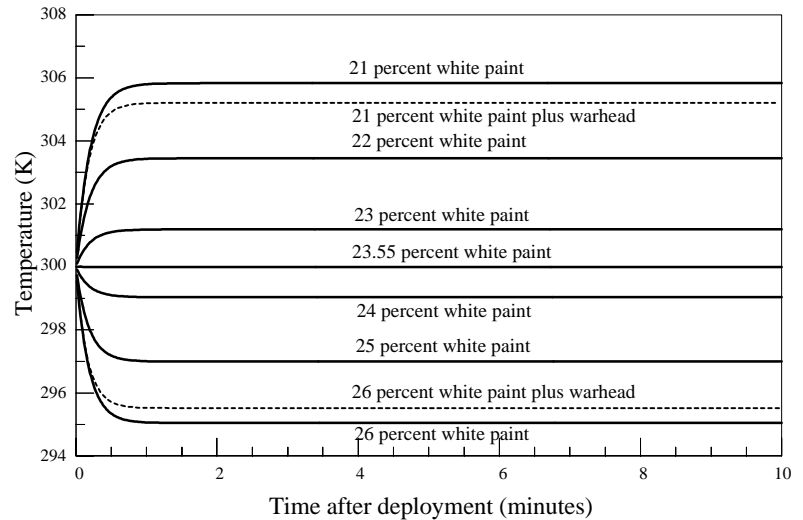

Figure 8-2. Temperature as a function of time after deployment of lightweight (0.5 kg) aluminum balloons coated with varying amounts of white paint to give equilibrium temperatures near 300 K (thick curves).

Changing the fraction of the balloon covered by white paint from 21 percent to 26 percent produces a temperature span of just over 10 K around 300 K. In addition, two balloons containing warheads with emissivities of 0.036 are also shown. These calculations assume that heat transfer occurs only through radiation to or from the warhead, but for one balloon the magnitude of the heat transfer is taken to be five times larger than it would actually be. The calculations also assume that both the balloon and the warhead are spherical; balloons and warheads of other shapes will give qualitatively similar results.

rium temperature of 297 K. However, the same coverage with white titanium dioxide paint gives an equilibrium temperature of 287 K and painting it with white epoxy paint gives an equilibrium temperature of 292 K. (All of these assume a warhead initially at 300 K with an emissivity of 0.036 inside, and heat transfer by radiation only.)

The attacker can instead introduce a variation in the balloons' equilibrium temperature by varying the shapes of the balloons (see Appendix A). For example, if a sphere with a diameter of 3 meters had an equilibrium temperature of 300 K, then a cylinder with the same surface composition that was 3 meters long and had a base diameter of 3 meters would have an equilibrium temperature of roughly 284 K.¹³ Thus, by using a variety of balloon shapes the attacker could also get a spread of equilibrium temperatures.

¹¹ Although our calculations allow the temperature of the warhead to vary, because the thermal mass of the warhead is large, its temperature would remain essentially unchanged during the trajectory.

¹² This is done to allow for the possibility that motion-driven gas convection could increase the heat transfer.

¹³ As discussed in Appendix A, for a balloon of a given surface coating, its equilibrium temperature will be proportional to the fourth root of the ratio of its average cross-sectional area to its surface area. For a sphere, this ratio is 0.25, and its fourth root is 0.707. For a cylinder that is 3 meters long and has a base diameter of 3 meters, the

For balloons designed to equilibrate around room temperature, the attacker could also introduce additional uncertainty by slightly heating or cooling the warhead prior to launch, and placing it in a balloon with the same equilibrium temperature. Then even if the defense could *exactly* determine the balloons' surface composition, it could not tell which balloon had the warhead inside. However, such heating or cooling of the warhead would not be necessary, since the defense would not be able to exactly determine the balloons' surface compositions (particularly when, as discussed below, the variation of temperature over the balloons' surfaces is taken into account).

Thus, we have shown above that neither the equilibrium temperature of a balloon nor the rate at which it obtains this temperature is sufficient for discrimination. In fact, it is clear that the attacker has many different options for designing balloons to prevent discrimination based on the thermal behavior of the balloons. The only possible thermal effect that might allow discrimination would be the very small drift in balloon temperature that could take place if the temperature of the warhead inside changed. However, this would only be a factor for balloons designed to have an equilibrium temperature considerably different from the warhead's initial temperature, and even so would be very small.¹⁴ Moreover, as we discuss next, the temperature of the balloons would not be uniform over their surfaces, and this variation would mask any small temperature drifts due to the warhead.

Nonuniform balloon temperatures. The above discussion assumes that the entire surface of each balloon would be at a uniform, albeit changing, temperature. However, in actuality this would not be the case because different parts of the balloon would be exposed to and absorb different amounts of incident radiation. For example, for a balloon directly between the sun and the earth, the hottest area of the balloon surface would be facing directly towards the sun, while the coldest area would be located about 90 degrees away.

ratio of its cross-sectional area to its surface area can vary between 0.167 and 0.212, depending on its orientation. If we assume an average of 0.2, we get a balloon temperature of 283.7 K for a balloon surface composition that would give a temperature of 300 K for a sphere. (See Appendix H.)

¹⁴ For example, consider an aluminum balloon containing a warhead with an emissivity of 0.036 and an initial temperature of 300 K. The temperature of the balloon would change at a rate of 0.0007 K per minute due to the changing temperature of the warhead.

The temperature variations due to this effect can be significant. NASA calculations for their Air Density Explorer balloon satellites indicated there would be about a 50 K temperature difference between the hottest and coldest points on the satellite (for the case in which 17 percent of the balloon surface was covered with white paint).¹⁵ If the inside of the balloon satellite were aluminum rather than mylar, this temperature difference would have more than doubled. These calculations assumed a balloon with a stable orientation relative to the sun. For a balloon without such a stable orientation, these temperature differences would get averaged out to some degree. However, unless the balloon was spinning in such a way that all parts of its surface received equal exposure to the sun, some temperature variation would remain.

There could also be temperature variations due to the distribution of paint on the surface of a balloon. In fact, the attacker could deliberately create hot and cold spots on the surfaces of the balloons by using different types of paints. (NASA used an area of white paint on the surface of its balloons to create a cold spot over the location of the radio tracking beacon inside the balloon.) From the point of view of the attacker, such temperature variations over the surface of the balloons would in fact be desirable, because if there were any possibility that the presence of the warhead inside the balloon would create hot or cold spots (for example via conduction along spacers), such deliberately created temperature variations would mask any such warhead effects.

Thus, in general, it must be expected that the balloons would not be at uniform temperatures, but would have significant and spatially complex temperature variations over the surface of each balloon. This would further complicate the already nearly impossible task of thermal discrimination.¹⁶

Nighttime Attacks. At night the situation is considerably different because the only significant external source of heating is infrared radiation from the earth.

¹⁵ Coffee, et al., figure 17.

¹⁶ In fact, even if the attacker designed the balloon enclosing the warhead to have an equilibrium temperature very different from the initial temperature of the warhead, and there was a very small drift in the balloon temperature due to the changing temperature of the warhead inside, such temperature variations over a balloon's surface would make precise measurements of the average temperature of the balloon very difficult and would prevent any potential warhead-related hot or cold spot from being used for discrimination.

At night all spheres at low earth-orbit altitudes would equilibrate at about 180 K, regardless of their surface composition. Objects of different shapes would equilibrate at slightly different, but still low, temperatures (see Appendix A).

Given this low equilibrium temperature, the effects of a room-temperature warhead inside a balloon could be quite significant. For example, the balloon discussed above (with 25 percent of its surface covered with white enamel paint), which would equilibrate at 297 K in sunlight, would at night equilibrate to about 180 K if empty but to about 187 K if it contained a warhead with a surface emissivity of 0.036 and the heat transfer was due only to radiation (and to 204 K if the heat transfer from the warhead is five times that due to radiation). However, the attacker can take straightforward measures to prevent discrimination based on the thermal effects of the warhead inside the balloon.

One straightforward way for the attacker to prevent discrimination would be to put heaters in the empty balloons and heat them to temperatures similar to that of the balloon containing a warhead. Such a heater would not need to provide a large amount of power. For a balloon with a shiny aluminum outer surface, a heater that delivered 25 watts to the interior surface of the balloon (the actual power output of the heater might have to be somewhat higher) would raise the balloon's equilibrium temperature from 180 K to 197 K. A heater that delivered 50 watts would increase the equilibrium temperature to 210 K. Such heaters could be made by depositing a resistive layer on the inner surface of balloon (or by using a resistive tape), similar to the way many rear car windows are defrosted. A small battery could be used to provide power.¹⁷ But there would be no reason to use even this big a heater if the attacker first reduced the heat transfer from the warhead to the balloon (in the ways we discuss below) so that the difference in equilibrium temperatures between an empty balloon and one containing a warhead would be only a few degrees K. In fact, keeping all the balloons at as low a temperature as possible would be to the attacker's advantage since the colder the balloons were, the more difficult it would be for an infrared sensor to detect them.

¹⁷ For example, a Duracell DL245 lithium manganese dioxide battery is capable of putting out 4.5 watts for at least 30 minutes. Each battery weighs 40 grams and they can be operated in series for higher power levels. It would be necessary to enclose them in superinsulation to keep them warm, as their performance falls off rapidly as their temperature falls below room temperature. For data sheets, see www.duracell.com/oem/lithium/DL245pc.html.

To reduce the heat transfer from the warhead, the attacker could vent out the inflating gas and give the surface of the warhead the lowest possible emissivity.¹⁸ By covering the warhead with shiny aluminum foil, the attacker could reduce the emissivity of this surface to 0.036. However, the attacker could devote special attention to reducing the emissivity of the warhead and thus ought to be able to obtain an even lower emissivity than that of aluminum foil. For example, the attacker could give the warhead a surface finish of polished silver, with an emissivity of 0.01.

The attacker would also want to use a balloon whose outside surface had an emissivity as high as possible, so it would radiate heat away rapidly. For example, the attacker could cover the entire surface of the balloon with white paint. In this case, and for a warhead with a surface of polished silver, the equilibrium temperature of the balloon would be 0.5 degrees K higher with the warhead than without it. Another option, which might give an even smaller temperature difference, would be to cover the warhead with a multilayer superinsulation, with the outer layer having a low emissivity.

Thus, the attacker could readily reduce the temperature difference to a few Kelvin or less. In this case, a heater of only a few watts power could be used to heat the empty balloons to the temperature of the balloon with the warhead. Of course, the attacker could give each balloon a slightly different temperature from all the others to further complicate the task of the defense.

Moreover, once the attacker reduced the heat transfer from the warhead to such low levels, the attacker could use entirely passive means instead of heaters to mask the presence of the warhead in one of the balloons.

One straightforward passive way for the attacker to mask the presence of the warhead would be to vary the shape of the balloons. As discussed in Appendix A, the equilibrium temperature of a balloon varies with its shape. By using balloons of different shapes, the attacker could introduce a range of equilibrium temperatures that vary by at least 10 K, more than sufficient to mask the presence of a low-emissivity warhead.¹⁹

¹⁸ Since the surface area of the balloon would be much greater than that of the warhead, reducing the emissivity of its inner surface would have a relatively small effect, and so here we will take the inside of balloon to be a blackbody with an emissivity of 1.

¹⁹ If, as discussed previously, we assume a cylinder with a ratio of cross-sectional area to surface area of 0.2, we get a temperature of 170 K instead of 180 K for a sphere.

Decoys Effective for Both Daytime and Nighttime Attacks. The attacker could also choose to use balloon decoys that would be effective for both daytime and nighttime attacks. As described above for nighttime attacks, the attacker could insulate the nuclear warhead and give it a surface coating with a low emissivity to reduce the transfer of heat from the warhead to the balloon during nighttime attacks. Again as described above, the attacker could either use balloons with slightly different shapes so they would have slightly different nighttime equilibrium temperatures or use a small heater in the empty balloons. Then to ensure that the decoys would also work for daytime attacks, the attacker could give the balloons a surface coating so they would have daylight equilibrium temperatures that were near room temperature but slightly different from each other. The surface coating would not significantly affect the nighttime equilibrium temperatures. If the attacker chose to use balloons of slightly different shapes, then they could be given identical surface coatings because the variation in shape would result in different daytime equilibrium temperatures. If the attacker chose to use balloons of the same shape with a small heater, then they could be given slightly different surface coatings to give them slightly different daytime equilibrium temperatures.

Discrimination by Radars: Mechanical Interactions Between the Warhead and Balloon

We have shown above that the attacker could take straightforward steps—simply choosing the surface coating and shape of the balloons—to prevent the NMD infrared sensors from being able to discriminate the balloon with the warhead inside it from the empty balloons by observing the thermal behavior of the balloons. We have also shown that these steps would work for both daytime and nighttime attacks.

However, there remains the possibility that a mechanical interaction between the warhead and balloon could change the balloon’s behavior in a way that the defense could observe and then use to determine which balloon contained the warhead. For example, a spinning warhead nutating about its spin axis might cause its enclosing balloon to nutate as well.

The X-band radars can make very detailed measurements of the time variation of the balloons’ radar cross-section and radial velocity, and may even be able to produce an rough image of the target. (See Appendix D for details.) In order for this capability to be useful, however, there needs to be a way for the defense to relate the observed signal to phenomena occurring

inside the balloon. As we discuss below, the attacker could take steps to prevent the defense from doing so.

The mechanical interaction between the warhead and balloon differs for a warhead that is not physically coupled to the balloon and one that is. In the case in which the warhead is not attached to the balloon, we can think of the warhead as “rattling around” inside the balloon. The warhead would collide with the inside surface of the balloon. Such collisions could have several effects on the balloon: they could change the velocity of the balloon, cause the balloon to spin or tumble, or change its shape.²⁰ Whether the NMD radars would be able to discriminate the balloon containing the warhead by observing such changes is difficult to assess. However, to avoid this possibility, the attacker could simply choose to physically attach the balloon to the warhead. This could be done using strings; the length could be such that the balloon is either tightly or loosely constrained when it is inflated. Alternatively, several spacer rods made of a low conductivity material could be used. The Explorer 9 satellite used a set of glass epoxy rods to stand off the transmitter unit from the

²⁰ First, collisions between the warhead and the balloon could slightly change the velocity of the balloon. For example, if there was on average 1 meter of “rattle room” and a collision took place every 10 seconds, then on average the balloon would change its velocity by about 10 cm/second with each collision, the radial component of which might be detectable by the radar. Thus the radar might be able to detect a pattern of discontinuous radial speed changes superimposed over a smooth variation of radial velocity as the warhead travels through space. However, if the inflating gas is vented out of a balloon, there will be considerable “give” in the balloon wall, and the relative motion of the warhead will be quickly damped out.

Second, each collision between the warhead and the balloon might also change the spin characteristics of the balloon. Thus the defense might, by observing the balloon over a period of time, be able to observe that the way in which it is spinning is changing in a way inconsistent with the balloon being empty.

Third, any tumbling motion of a non-spinning warhead may get transferred to the enclosing balloon over a period of time, resulting in changes in the tumbling motion of the balloon that may be detectable. The attacker can attempt to minimize such differential tumbling by inflating the balloon after the warhead is deployed, so that the inflated balloon tumbles in the same way as the warhead.

Fourth, collisions could “dent” the balloon, slightly changing its shape. This could result in changes in the balloon’s radar cross section that the radar might be able to detect superimposed on top of the changes taking place as the balloon spins or tumbles through space.

balloon's inner surface. In either case, the balloon would move with the warhead, eliminating the detection possibilities discussed above for an unattached warhead.

The remaining concern of the attacker would be that some characteristic of the balloon and warhead motion would be measurably different from that of an empty balloon.

If the warhead is not spinning, but is tumbling, then the balloon will tumble in the same way as the warhead. However, empty balloons could also easily be made to tumble when they are ejected from the missile (in fact, it may be difficult to make them *not* tumble). The defense would not know precisely what the underlying tumbling behavior of the warhead is.

If the warhead is spinning, then the balloon will take on the spin characteristics of the warhead (assuming the balloon skin is sufficiently rigid). However, empty balloons could also be made to spin—as indeed the Air Density Explorer Satellites were. More complex motions of the warhead could occur, such as nutating about its spin axis. However, such motions could also be simulated by empty balloons using properly distributed weights on the inner surface of the balloon. Indeed, even if the warhead is not spinning, the attacker could deploy several balloons specifically designed to have spin and nutation characteristics similar to what a spinning warhead might have.

The attacker might also be concerned that the attachment points would distort the balloon, making the one containing the warhead look different from the others. In general, this would argue against making the balloons perfectly spherical, so that any such distortion would not stand out. Clearly the attacker could also introduce deliberate distortion into empty balloons in order to mask any such effect. For example, if the attacker used strings to attach the warhead to the balloon, it could also use a simple structure of strings in the empty balloons so that the surface of the balloons would be exactly the same whether there was an internal string structure or a warhead to which the balloon was tethered.

More generally, the attacker could use a variety of techniques to obscure any motion that would signal the presence of a warhead, or as noted above, could even design one or more of the empty balloons to produce observable effects of the type that the defense would be trying to exploit in order to identify the balloon with the warhead. For example, some or all of the balloons could be equipped with a small vibrational device. If balloons that retain the inflating gas are used, one could be equipped with a small valve that would be opened

periodically for a short period, giving the balloon a small “kick.” The attacker could also tether a number of the balloons together, using either flexible or rigid tethers, to obscure any motions of the balloon containing the warhead. The possibilities of this type are numerous. Thus, even if the defense saw signatures of the type that it would associate with a warhead inside a balloon, until it actually saw an interceptor kill vehicle impacting a warhead, it could not be sure the balloon contained a warhead.

Discrimination and Intercept During Early Reentry

As discussed above, by enclosing the warhead in a balloon and simultaneously releasing numerous empty balloons, the attacker could prevent discrimination by both infrared sensors and radars as the balloons travel through the vacuum of space in the midcourse part of their trajectory.

However, if the attacker took no other measures to prevent it, the X-band radars might be able to discriminate the balloon with the warhead from the other balloons early in the reentry phase of their trajectories by measuring the velocities and positions of the balloons.²¹ Although for many purposes the atmosphere can be treated as negligible above altitudes of 100 kilometers, here we consider the possibility of discrimination at significantly higher altitudes. As the balloons descend through the atmosphere, the lighter-weight empty balloons would be slowed more by atmospheric drag than would the heavier balloon with the nuclear warhead. This effect is sometimes called “atmospheric filtering.” If the effects of atmospheric drag on the decoys relative to the much heavier warhead became apparent at a high enough altitude, the defense might have enough time to attempt to intercept the warhead before it passed below the kill vehicle's minimum intercept altitude.

In general, the heavier the balloons, the lower the altitude at which they could first be discriminated.²²

²¹ The ability of the upgraded early warning radars to accurately measure small velocity or position changes due to atmospheric drag will be far inferior to that of the X-band radars (see Appendix D).

²² The discrimination altitude would also be lower the smaller the balloon was, but since the balloons must be able to contain a warhead, they could not be made too small. The behavior of an object during reentry is largely determined by its ballistic coefficient, $\beta = W/(C_D A)$, where W is the object's weight, A is its cross-sectional area perpendicular to its velocity, and C_D is the drag coefficient. At altitudes above where the mean free path of air molecules is large compared with the size of the balloons, the drag coefficient

For example, Figure 8-3 shows the change in velocity due to atmospheric drag of three balloons with masses 0.5, 5, and 20 kilograms relative to that of a balloon containing a 1,000 kilogram warhead, for altitudes less than 500 kilometers. In this case, the balloons are spheres with a diameter of three meters. For a light-weight 0.5-kilogram balloon, the velocity change due to atmospheric drag would be roughly one meter per second at an altitude of 250 kilometers. For a 5 kilogram balloon, the velocity change due to atmospheric drag would be roughly 0.1 meters per second at an altitude of 250 kilometers.

Figure 8-4 shows the change in position (along the trajectory) due to atmospheric drag of balloons of various weights (again relative to that of a balloon containing a 1,000-kilogram warhead), for altitudes less than 500 kilometers. For example, for the 5-kilogram balloon, the displacement due to atmospheric drag would be roughly 1 meter at an altitude of 275 kilometers.

Nevertheless, statements by BMDO officials make it clear that they are counting on being able to discriminate the warhead in midcourse and are not planning to use atmospheric filtering to discriminate it during reentry. For example, NMD Program Manager Maj. Gen. William Nance stated recently that the greatest technical challenge in getting to the objective system and being able to deal with “more complex countermeasures” was the step from the C1 to the C2 system.²³ Yet the transition from the C1 to the C2 system does not place any X-band radars in the lower-48 states or Hawaii. Thus, the C2 system would have no X-band radars that could observe the reentry phase of a trajectory aimed at the lower 48 states or Hawaii, and therefore could not even attempt to use atmospheric filtering to discriminate the warhead for such attacks.

of the balloons would have a value of $C_D = 2$, independent of their shape. The mean free path of molecules in the atmosphere is several meters at 120 kilometers altitude.

²³Michael Sirak, “A C1 to C2 Move Is NMD System’s Most Stressing Upgrade, Says NMD Head,” *Inside Missile Defense*, 3 November 1999, p. 10.

Velocity Change due to Drag

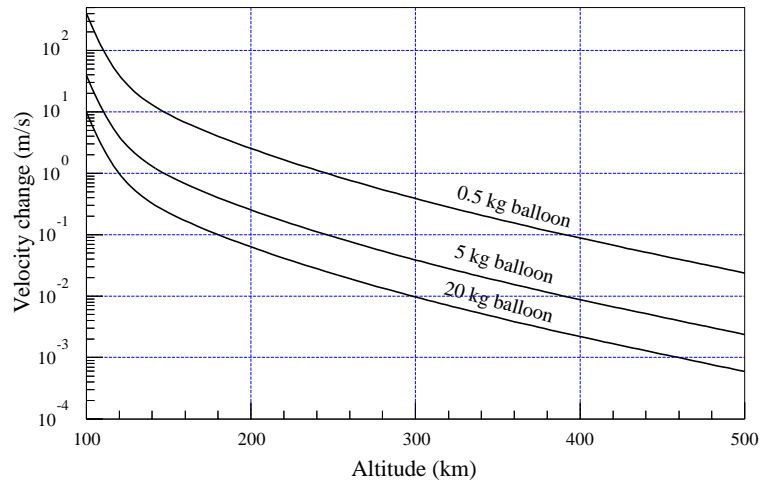

Figure 8-3. Velocity change due to drag. This figure shows the change in speed due to atmospheric drag at various altitudes for three balloons with diameters of 3 meters and different masses, relative to the case of no drag. Since at these altitudes, the drag would have negligible effect on a heavy object like a nuclear warhead, these are effectively speed changes of the balloons relative to a warhead. The calculations assume the balloons are on a standard, 10,000-km range trajectory.

Position Change Due to Drag

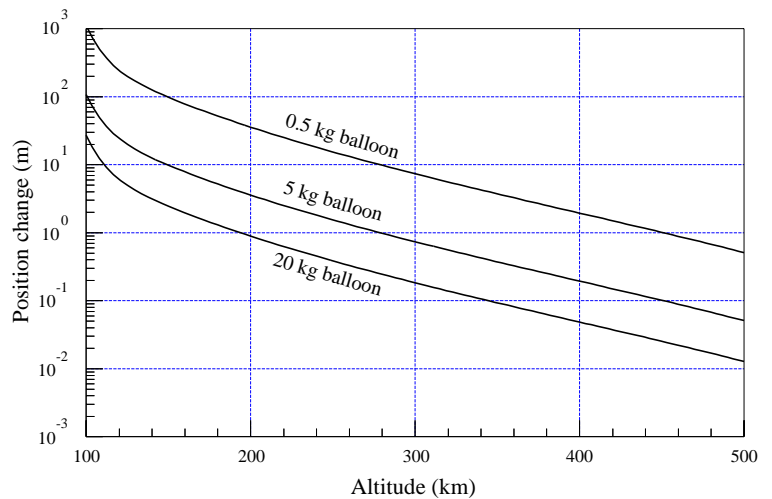

Figure 8-4. Position change due to drag. This figure shows the change in position along the trajectory due to atmospheric drag for three balloons of different mass, relative to the case of no drag. Since at these altitudes, the drag would have negligible effect on a heavy object like a nuclear warhead, these are effectively changes in the positions of the balloons relative to a warhead. The calculations assume the balloons are on a standard, 10,000-km range trajectory.

Another indication that the NMD system is not intended to discriminate using atmospheric filtering is that the X-band radars that are being built for the NMD system would have only a single face with a limited field of view (see below). A radar would therefore need to physically rotate to view balloons on widely separated trajectories as they neared the radar during reentry, which is when the radar would need to track them for atmospheric filtering. As a result, the radar would likely be unable to track balloons deployed by missiles on widely separated trajectories (such as those aimed at different cities). Thus, NMD X-band radars are not appropriate for a defense system designed to do atmospheric filtering.

It is not surprising that the United States is not planning to discriminate the warhead during reentry. For attacks against cities that are not located near one of the interceptor launch sites (which would include most US cities and the vast majority of the US population), the defense would have to launch its interceptors well before it could use atmospheric filtering to discriminate the balloon with the warhead, in order for the interceptor to have enough time to reach the intercept point. If the defense were able to discriminate the target from the decoys at a high enough altitude, it would then need to divert the interceptors in mid-flight once discrimination took place.

For example, for a North Korean attack on San Francisco, the interceptors closest to the reentry part of the trajectory would be those at Grand Forks, North Dakota.²⁴ It would take an interceptor at least 6.5 minutes to reach a potential intercept point near San Francisco. The defense could wait as long as possible to launch its interceptors by aiming at an intercept point just above the kill vehicle's minimum intercept altitude, say 150 kilometers. For a standard trajectory from North Korea to San Francisco, the balloons would be at an altitude of roughly 1,050 kilometers when the interceptors were launched (and at higher altitudes if North Korea used a lofted trajectory). If the defense wanted to attempt intercepts before the last possible second, the balloons would be at even higher altitudes when the interceptors would need to be launched. It would not be possible for the X-band radars to use atmospheric filtering to discriminate lightweight decoys

from a balloon containing a warhead at such a high altitude, so the defense would have to launch its interceptors before it could distinguish the target from the light decoys.

The fact that the defense would have to launch its interceptors well before atmospheric discrimination could begin would present the defense with a significant problem. The defense would have to decide how many interceptors to launch and at what intercept point to launch them before it could know how many of the balloons the radars could filter out and at what altitude this discrimination would take place. Although the defense could determine the size of the various balloons in midcourse, it could not determine the weight of each balloon decoy, and hence the altitude at which it could potentially be discriminated, until reentry. The defense would also not know how much total weight the attacker could devote to decoys, since that would depend on what the payload capacity of the missile was and how heavy the warhead was. Moreover, if North Korea had a missile that could deliver a warhead to 11,000–12,000 kilometers, which would be required to reach targets throughout the United States, it could carry considerably more weight to the shorter ranges needed to attack targets in Hawaii or the western United States.

The attacker could use a mix of balloon weights, either by making some balloons from thicker material or by putting small weights inside lighter balloons. (Like the nuclear warhead, these weights could be attached to the balloon by several strings or spacers of the appropriate length.) The heavier balloons would reach lower altitudes before they could be discriminated than would the lighter balloons. The attacker would probably want to have a relatively large total number of decoys to prevent the defense from trying to intercept all the balloons in midcourse. At the same time, the attacker would probably want to have a number of heavy decoys that would be difficult for the defense to discriminate in reentry.

If we assume that a missile carrying a nuclear warhead could devote 100 kilograms of payload to the balloons, then the attacker could easily deploy dozens of balloons of various weights. For example, the attacker could deploy 3 dozen lightweight balloons each weighing 0.5 kilograms and each using a deployment mechanism weighing another 0.5 kilograms. It could put the nuclear warhead in one balloon, and then use the remaining payload to distribute roughly 60 kilograms of weights throughout other balloons. For example, it could use six 10-kilogram decoys or twelve 5-kilogram decoys, or a mix of both.

²⁴ Although the trajectory might carry the balloons relatively close to the interceptor site in Alaska, they would then be at very high altitudes. Since the defense must rely on atmospheric filtering, the engagement must occur when the warhead is near San Francisco and thus closer to the North Dakota site.

Of course, the defense would not know how much of the payload the attacker devoted to decoys or what mix of balloon weights the attacker chose to use. But if the defense was planning to use atmospheric filtering for discrimination and saw dozens of balloons deployed from each missile, it would need to assume that some of these balloons would be heavy enough to deny discrimination above the kill vehicle's minimum intercept altitude.

To achieve the high effectiveness and confidence levels planned for it, the defense would need to err on the side of launching too many interceptors. Since the defense reportedly plans to fire up to four interceptors per target, if it made the reasonable assumption that a dozen or more balloons would remain viable decoys, the defense would have to launch several dozen interceptors per missile to have high confidence that it could prevent the warhead from getting through.

Thus, because the defense would need to launch its interceptors before it knew how many of the decoys would remain viable down to its minimum intercept altitude, it would need to fire a large number of interceptors at the balloons deployed by each attacking missile. Recall that the planned NMD system is intended to defend against an attack of tens of missiles from North Korea and other emerging missile states. Thus, the defense would still be in the position of choosing between letting the warhead penetrate unchallenged or running out of interceptors.²⁵

For this reason, forcing the defense to abandon its preferred midcourse intercept strategy to operate in this "last chance" mode would use up a large number of interceptors and would significantly degrade the confidence in the defense effectiveness. Moreover, as we discuss below, the attacker has several ways in which it can exploit some of the limitations of the X-band radars to further complicate this defense tactic.

First, we consider what steps the attacker could take to prevent discrimination at altitudes that would be high enough to permit an intercept. Second, assuming the X-band radar viewing the reentry part of the trajectory was able to discriminate the balloon containing the warhead from the others, we consider what steps the

²⁵ If the attacker had more missiles than nuclear warheads and was trying to force the defense to run out of interceptors, it might choose to use a missile to deploy only decoy balloons. A missile not carrying a nuclear warhead (and with a total payload of 1,000 kilograms) could deploy three dozen balloons with an average weight of 25 to 30 kilograms. Since the defense could not know that none of these balloons contained a warhead, it would have to assume that one did.

attacker could take to prevent the radar from determining the *position* of the discriminated balloon accurately enough that this information would be useful to the kill vehicle, which must still home on the target using its own sensors.

Measures the Attacker Could Take to Prevent Discrimination. There are several measures an attacker could take to lower the altitude at which an X-band radar could discriminate the balloon containing the warhead from a balloon decoy. We discuss some of these below. The attacker could use some of these measures in combination with the others.

Denying High Precision Velocity and Position Measurements. As discussed in Appendix D, the X-band radars that would be part of the NMD system should be capable of making very precise measurements of the radial velocities of the balloons. Specifically, these radars would be able to measure the Doppler shift in the frequency of the radar return due to the radial component of an object's velocity. However, an X-band radar could not use Doppler shifts to measure the component of velocity in the direction perpendicular to the radar line of sight (i.e., the cross-range direction). The radar could measure the cross-range velocity of a balloon by plotting its angular position versus time, but because radars are limited in their ability to measure the angular position of an object, this method is generally less accurate.²⁶ Thus, an X-band radar would not be able to measure the cross-range velocity of a balloon as accurately as the radial velocity.

The X-band radars should also be capable of measuring the range to each balloon with high accuracy (see Appendix D). However, an X-band radar would

²⁶ While the radar would not be able to measure the cross-range position of a given balloon with high accuracy, it could possibly use ISAR (Inverse Synthetic Aperture Radar) techniques to image the collection of balloons and determine the position of the one containing the warhead relative to that of the other balloons (see Appendix D). However, since the collection of balloons—whether or not they were tethered together—would not be rigid, ISAR would be of very limited utility. Using the orbital motion to generate an ISAR image would take time, perhaps tens of seconds. A single image is only accurate in two dimensions, not three, although full three-dimensional imaging is (again in principle) possible if the radar makes two separate images with the right separation in angular aspects of the two images. If the attacker considers ISAR techniques to be a threat, it could take measures to thwart ISAR, including random motion of surfaces or appendages on the warheads and decoys, or random motion of the entire object (via

not be able to determine a balloon's angular (or cross-range) position with as great an accuracy as its range, even after tracking it for most of its trajectory.

Although the C3 NMD system would deploy up to nine X-band radars around the world, only some of these would be in a position where they could view the reentry phase of a missile trajectory that was targeted on the United States. Moreover, for attacks on most US cities, only one X-band radar would be in a position to view the reentry phase of the trajectory below an altitude of 400 kilometers. (See Table 8-2). Thus, the defense would have to rely on the measurements of one X-band radar to determine the velocity and position of the balloons during reentry.

The atmospheric drag would affect the total velocity and displacement along the trajectory of an incoming balloon, not just the components of velocity and displacement in the direction towards the radar. Therefore, unless the balloon was on a trajectory directly towards the X-band radar, the defense would need to estimate the total velocity of the balloon based on the radar's very accurate measurements of the balloon's radial velocity and its less accurate measurements of the balloon's cross-range velocity. Similarly, the defense would need to estimate the displacement along the trajectory based on its very accurate range measurements and its less accurate measurements of the balloon's cross-range position. The defense could attempt to use these velocity and position estimates for discrimination by comparing them with the values that would be expected for a balloon containing a heavy warhead and with those estimated for each of the other balloons. By making repeated measurements of the balloons and attempting to fit them to trajectories, the defense can reduce but not eliminate these uncertainties.

As discussed in more detail in Appendix D, the precision with which a radar could measure the radial velocity of an object depends in part on the characteristics of the X-band radar and how it was operated. For example, it would depend on the integration time chosen by the operator. Because some of these detailed characteristics about the X-band radars and how they would be operated are not publicly available, we cannot determine precisely the accuracy with which an X-band radar could measure the radial velocity of an incoming balloon. However, even if the X-band radar

cold-gas thrusters). Either technique would deny the fine Doppler discrimination necessary for ISAR images. The motions of surfaces and appendages would not need to be large; amplitudes of a radar wavelength (about 3 cm) would be sufficient.

Table 8-2. The radar horizon for targets at different altitudes.

Because the earth's surface is curved, a radar would not be able to see a target at a given altitude if the target was further away than the corresponding radar horizon for that altitude. This table gives the radar horizon (the ground distance at which a radar could observe a target) for targets at different altitudes, assuming the radar can view an object 3 degrees above the horizon. For example, a radar would not be able to see an object at an altitude of 500 kilometers if that object was more than 2,250 kilometers from the radar (as measured on the ground.) Alternatively, the radar could only see an object at a distance of 2,250 kilometers from the radar if that object was at an altitude of 500 kilometers or greater.

Altitude of target (km)	Radar horizon (km)
500	2,250
400	2,000
330	1,800
250	1,500
200	1,300
150	1,100
130	1,000

could measure the radial velocity *perfectly*, the limitations in how accurately it could measure the cross-range velocity would limit how accurately it would know the total velocity of a balloon. Similarly, even if the X-band radar could measure the range of a balloon perfectly, the limitations in how accurately it could measure the cross-range position would limit how accurately it could know the position of a balloon along its trajectory.

From the defense perspective, these inherent measurement limitations would be least problematic for missiles on trajectories that approached the radar directly during reentry and worst for missiles on trajectories with a reentry that was perpendicular to the radar line of sight. Thus, the attacker could exploit these radar limitations by targeting cities not located directly in front of an X-band radar (of which there would be many). Doing so might be enough to prevent the defense from discriminating even relatively lightweight balloons at a high enough altitude to allow an intercept attempt. (See box.)

Nevertheless, the attacker might still choose to take other steps to lower the defense's discrimination altitude, as we discuss below.

Exploit the Defense Geometry. The attacker could make atmospheric filtering more difficult by exploiting other defense weaknesses. As noted above, the planned NMD system may have a serious vulnerability since each X-band radar would have only a single face with a limited electronically scanned field of view

of about 50 degrees in both azimuth and elevation. The radar would therefore need to rotate to view balloons on widely separated trajectories (with azimuths that varied by more than 50 degrees). One offensive tactic would be to launch two (or more) missiles, timed to arrive simultaneously, with one aimed at a target to one

The Velocity and Position Measurement Accuracy of an X-Band Radar

To what accuracy, in actual practice, an X-band radar could measure the location and velocity of an object is not publicly known. In this box we estimate limits on this accuracy based on general principles.

The discussion here assumes that the accuracy with which a radar can measure an object's angular position after tracking it for a period of time is roughly given by the radar beamwidth divided by 100 (see Appendix D, particularly equation (D-3), which for the NMD X-band radars would be roughly 2.4×10^{-5} radians, or 0.0014 degrees. Thus, for the discussion in this box, we assume the cross-range measurement accuracy would be approximately given by $(2.4 \times 10^{-5}$ radians) R , where R is the range from the radar to the object (not the ground range). The cross-range position uncertainty would increase with the object's range from the radar; for an object during reentry at a range of 500 kilometers from the radar, it would be roughly 12 meters. If the actual angular position measurement accuracy is less than or greater than the beamwidth divided by 100, these figures should be scaled accordingly.

Consider an object travelling on a trajectory at an angle γ with respect to the line of sight of the radar. At any given time, the radar could accurately measure the range to the object, but would measure its cross-range position with an uncertainty $R \Delta\theta$. Thus, the uncertainty in the object's position along its trajectory, ΔP , would be approximately $\Delta P = R \sin \gamma \Delta\theta$, where R is the range from the radar to the object. (This is easily seen when the object is travelling perpendicular to the line of sight of the radar, so that $\gamma = 90$ degrees, since ΔP is then just the full cross-range uncertainty in the position.) For a balloon reentering at an angle γ of 30 degrees or greater, the position uncertainty along the trajectory ΔP would be roughly 6 to 12 meters at a range R of 500 kilometers (when the balloon was at an altitude of 200 kilometers), and roughly 12 to 24 meters at a range R of 1,000 kilometers.^a

Next consider the same object travelling at a velocity V and an angle γ with respect to the line of sight of the radar. At any given time, the radar can accurately measure the radial component of velocity V_r . We assume it can measure V_r perfectly. The defense then estimates the full velocity from this measurement by using $V = V_r / \cos \gamma$. But the value γ is uncertain since the defense does not know the object's trajectory precisely. The uncertainty in V due to the uncertainty in γ is thus $\Delta V = V \tan \gamma \Delta\gamma$. Since V is large, even a small $\Delta\gamma$ can lead to a significant uncertainty ΔV .

The uncertainty in determining the object's trajectory arises from the uncertainty in measuring its angular position. On the other hand, tracking the object over time and attempting to fit the measurements to a trajectory allows the defense with repeated measurements to reduce the angular uncertainty $\Delta\theta$ of the object's position to the value given above. Thus, the uncertainties $\Delta\gamma$ and $\Delta\theta$ are related, and we expect that they must be roughly the same size, or about 2.4×10^{-5} radians. Using this value of $\Delta\gamma$, a balloon reentering at a speed V of 7 kilometers per second would have a velocity uncertainty ΔV of roughly 0.1–0.2 meters per second for trajectories having γ equal to 30 degrees or greater.

Thus, the defense would have the most difficulty if the attacker targeted cities that were on trajectories that did not travel directly toward an X-band radar during reentry.

Moreover, these estimates suggest that the inaccuracy ΔP with which the defense could determine the position of a balloon along its trajectory may be great enough that the defense could not use position along the trajectory for discrimination. For example, the position uncertainty would be roughly the same size as the position change due to drag on a 5-kilogram balloon at 150 kilometers altitude (see Figure 8-4).

^a This assumes the trajectory is a standard one with a reentry angle of 23.5 degrees with respect to the earth.

side of the radar and the other at a target on the other side of the radar. For example, North Korea could launch missiles that were simultaneously targeted on San Francisco and San Diego, and Iran or Iraq could launch missiles that were simultaneously targeted on Boston and Washington. Depending on the speed with which the X-band radar (in California and Massachusetts, respectively) was able to rotate, it would lose time and might even be unable to observe the reentry portion of one of the two missile trajectories. For example, if the radar could rotate at a rate of 10 degrees per second, 15–20 seconds might be required to switch between the two targets.²⁷ In practical terms, this would likely force the radar to choose to observe only one of the targets during the critical reentry phase.

Cold-Gas Thrusters. Another option for the attacker would be to use small thrusters to speed up the empty balloons or slow down the balloon containing the warhead.²⁸ To avoid having to equip each decoy with its own thruster (and orientation system), the attacker could equip the warhead with such a thruster and then orient the warhead so that the thrust is along its velocity axis. Such a drag-simulating thruster could use cold gas to avoid being detected by infrared sensors. While this measure may sound difficult, small thrusters of the type that would be needed for this purpose would not be difficult to make or acquire and are certainly simpler technology than that required to make a long-range missile, which the attacker is assumed to have.

As noted in Appendix E, two decades ago Britain reportedly developed decoys with small liquid-fueled thrusters attached to compensate for the difference in atmospheric drag on light decoys and heavy warheads during reentry.²⁹

Spinning or Oscillating Balloons. To create variations in the velocity and position of the surface of the balloons and thus mask the effects due to atmospheric drag, the attacker could spin the balloons as they were released. By using a balloon with an irregular shape, and/or attaching lightweight corner reflectors (which

could be made out of aluminum foil) at random positions to the surface of a spherical balloon, the attacker would ensure that strong radar reflections would be generated by various parts of the balloon as it spun. The attacker could spin the balloons so that the surface velocities due to spinning would be large compared with the velocity changes due to atmospheric drag.³⁰ The X-band radar would then see a set of irregular time-varying Doppler shifts from each balloon that would mask the velocity change due to atmospheric drag. The irregularity and spinning would also mask the displacement of the balloons due to atmospheric drag. To enhance this effect, the attacker could even make irregular star-shaped balloons that had long points sticking out with corner reflectors attached to them. Constructing such balloons would not require high quality control since variations between the balloons would only add to the variation of the signals seen by the radar. Moreover, if the balloon was nutating or more generally spinning in a complicated way, which one would expect, this would tend to randomize the Doppler shifts seen by the radar.

Rather than spinning the balloons, the attacker could use lightweight springs to cause variations in the velocity and position of the surface of the balloons. For the balloons containing small weights or a warhead, the attacker could attach one or more springs between the weight (or warhead) and the balloon. The springs would remain compressed during most of the balloon's flight, so that these balloons could not be distinguished from those without springs. A simple timer could then release the springs early in reentry. The springs would cause the balloon to oscillate irregularly around the center of mass. Using two springs with different spring constants attached to different parts of the balloon could produce a very complicated motion. The attacker could even add a small battery-powered motor to drive the springs if it was concerned about the oscillations damping during reentry.

As a result of simple measures like these, the radar would measure a time-varying spread of velocities and positions for each balloon. The irregularity in the

²⁷ Ten degrees per second appears to be a typical rotation rate for such large radar structures.

²⁸ Richard L. Garwin. "The Future of Nuclear Weapons" presentation for the Second ISODARCO School, Beijing, China, April 1990.

²⁹ Robert S. Norris, Andrew S. Burrows, and Richard W. Fieldhouse, *Nuclear Weapons Databook, Volume 5: British, French, and Chinese Nuclear Weapons* (Boulder, Colo.: Westview Press, 1994), p. 113.

³⁰ A balloon with a diameter of 3 meters spinning at one revolution per second would have a maximum surface velocity due to the spinning of about 10 meters per second, whereas one spinning at 5 revolutions per second would have a maximum surface velocity of about 50 meters per second. In these cases, the difference in surface velocity between one edge of the balloon and the edge on the opposite side would be 20 and 100 meters per second, respectively.

Doppler shifts and the position measurements would keep the radar from being able to time average to find the small signal it was looking for. Thus, although the defense would be able to average out these effects to some degree, the attacker could deny the radar the extremely precise measurements that would be required for discrimination at high altitudes.

Tethered Clusters of Balloons. The attacker could tether together the balloons deployed by a missile in one or more clusters so that during the early part of reentry, the balloon containing the warhead would help compensate for the drag on the others in the cluster. Thus, tethering would reduce the change in velocity and position that the lighter weight balloons would experience due to atmospheric drag relative to the balloon containing the warhead. Even at an altitude of 200 km, the atmospheric force on a balloon with a diameter of 3 meters is less than 0.14 newtons (half an ounce) so the tethers would not need to have much structural strength. Moreover, if the decoys were spaced close enough together, then even if the radar could discriminate the balloon containing the warhead, it would not be able to spatially resolve the individual balloons in order to provide information to the kill vehicle as to which balloon was the target.

Exploit Defense Limitations in Determining the Target Position

Even if the X-band radars could discriminate the balloon with the warhead from the other balloons, the radar would need to convey this information to the kill vehicle in a form that would allow the kill vehicle to identify and home on the correct balloon. Ideally, the radar would create a three-dimensional “map” of the balloons, and the defense would then use this information to create a two-dimensional map of the balloons as seen by the kill vehicle.

However, the inability of radars to measure the cross-range position of an object with high accuracy means that a map an X-band radar constructs could have intrinsic ambiguities regarding the position of the objects it sees. Depending on the situation, these ambiguities could prevent the radar from being able to construct a map that the kill vehicle could use to identify the proper target.

More specifically, as we discuss above, an X-band radar viewing the reentry of a cluster of balloons would be able to determine that a given balloon was located at a certain range, but in the cross-range directions could only tell that it was located within a circular area per-

pendicular to that range. We will refer to that circular area within which the X-band radar can locate the object as the “uncertainty disk.” The size of the uncertainty disk grows as the distance from the radar. If the balloons were close enough together and far enough away from the radar, their uncertainty disks would overlap so that the radar would not be able to physically distinguish the balloons in the cross-range directions. In this case, the radar could only distinguish different balloons by their range, but could not create a three-dimensional map of where the balloons were relative to one another.

The infrared sensor on the kill vehicle would not be able to measure the range to an object, but only its angular position. The ambiguity in the radar map would mean that in general, if the balloons were close enough together, the kill vehicle could not determine the position of the target using the radar map. This would only be possible for some cases, depending on the intercept geometry.

The optimal situation for the defense would be if the kill vehicle were approaching the object at roughly 90 degrees to the radar line of sight, in which case there would be no uncertainty in the cross-range positions of the two balloons as seen by the kill vehicle. The worst situation for the defense would be if the kill vehicle line of sight were the same as that of the radar, then the radar would simply pass on the uncertainty in the cross-range positions of the two balloons to the kill vehicle.

Thus, the attacker could make the map confusion problem worse for the defense by attacking cities for which the radar and kill vehicle lines of sight to the reentry part of the trajectory would not be close to 90 degrees during the reentry phase. The attacker could also choose to attack cities far from the radar so that the distance from the radar to the object would be large and the uncertainty in cross-range position would be large.³¹

We illustrate this problem in Figure 8-5 for a case in which there are only three balloons. However, the map confusion for the kill vehicle would increase as the number of balloons increased.

By considering a simple case with two balloons having their uncertainty disks centered on the radar line of sight we derive an estimate of when the radar map could be inadequate to determine the position of two balloons as seen by the kill vehicle. The condition is:

³¹ The attacker could even use cold-gas thrusters on some of the balloons, as described above, but oriented in random directions to create greater confusion during reentry.

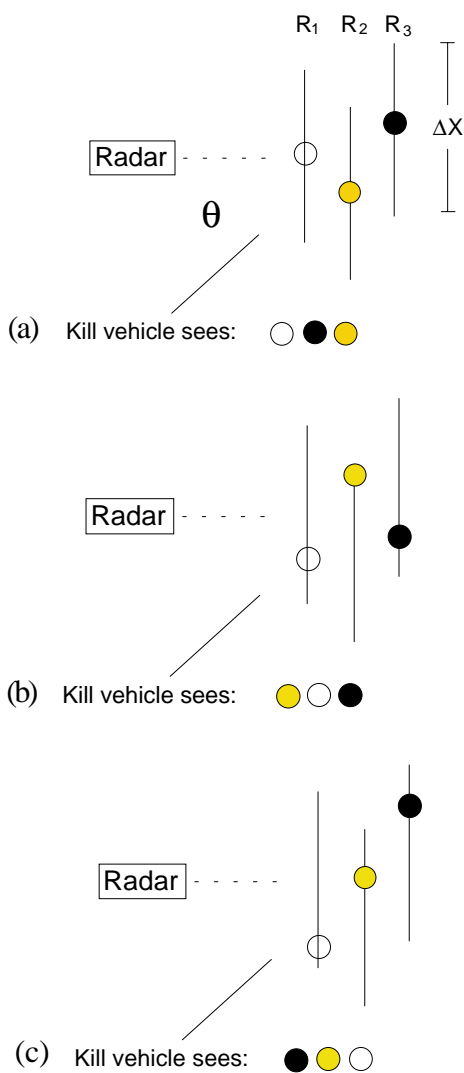

Figure 8-5. Radar map confusion for three balloons. This figure shows a simple situation in which the radar observes three balloons, at ranges R_1 , R_2 , and R_3 from the radar. The balloons are distinguished by shading in the figure, but would be indistinguishable to the kill vehicle. The plane of the page is the plane containing both the radar line of sight and the kill vehicle line of sight to the target cluster. In this plane, the kill vehicle line of sight is at an angle θ with respect to the radar line of sight.

The radar's best guess at the cross-range positions of the balloons is shown in (a), along with the uncertainty disk for each balloon. The uncertainty disks are shown here edge-on as lines with a length equal to the cross-range uncertainty ΔX .

But the balloons may actually lie anywhere on their uncertainty disks (and need not lie in the plane of the paper, since the disks are two dimensional). Figures (b) and (c) show other possible positions of the three balloons. As shown, the kill vehicle would see very different relative locations of the balloons in the three cases. Thus, even if the X-band radar could identify the balloon containing the warhead, it could not in this case construct a map that would allow the kill vehicle to identify that balloon.

$$\Delta R = (R_2 - R_1) \leq \Delta X / \tan \theta = (2.4 \times 10^5) \times R / \tan \theta \quad (8-1)$$

where R_2 and R_1 are the ranges from the radar to the two balloons, θ is the angle between the kill vehicle and radar lines of sight, ΔX , is the uncertainty in the radar measurement of the cross-range position of the balloons, and R is the approximate range from the radar to the balloons.

Equation (8-1) shows that the position confusion could occur for any angle θ as long as $\Delta R/R$ was sufficiently small. The attacker could ensure that this ratio was small by tethering the balloons together. Note that ΔR is the component of the separation between balloons along the line of sight of the radar, and in general will be smaller than the physical spacing of the balloons. Assuming the cluster of balloons was slowly rotating, the ranges from the radar to the various balloons would change, and the range differences ΔR between pairs of balloons could get arbitrarily small as balloons rotated past each other. The potential for confusion would increase significantly as the number of balloons in the cluster increased.

To understand the effect of this position confusion on the defense, we consider several specific attack scenarios. We assume that all of the X-band radars planned for the full C3 system would be in place, and that interceptors could be launched from either of the sites in Alaska and North Dakota. We further assume that the radar would attempt to identify the warhead by atmospheric filtering, so that the intercept attempt would occur late in the trajectory. We look at the geometry of the intercept engagements, and determine what value of ΔR would lead to the confusion described above, and could thus prevent the kill vehicle from attempting to intercept the right balloon.

We find that for attacks from North Korea against Seattle or Los Angeles, such position confusion could occur if the range differences ΔR seen by the radar were less than about 10 meters.³² The attacker could easily ensure this would be the case by tethering the balloons

³² For a North Korean attack on Seattle, the closest radar would be the one at Beale Air Force Base in Northern California (to be deployed as part of the C-3 system) and the interceptors could be launched from either Alaska or North Dakota. At an altitude of 150 kilometers, the slant range from the balloons to the radar is roughly 1,200 kilometers. For interceptors launched from North Dakota, θ would be approximately 70 degrees; for interceptors launched from Alaska, θ would be closer to 180 degrees. Thus, it would be to the advantage of the defense to use the interceptors launched from North Dakota. In this case, position confusion could occur if ΔR were roughly 10 meters or less.

together. We find a similar result for attacks from Iran or Iraq against Los Angeles.³³ For an attack from Iran or Iraq against Chicago, position confusion could occur if the range difference were less than about 40 meters.³⁴

If the reentry of the balloons could be seen by more than one X-band radar, it might be possible for the defense to combine the position information provided by

the multiple radars to construct a better map for the kill vehicle and to eliminate or reduce the position confusion discussed above. However, as discussed above, since we are considering engagements below about 400 kilometers altitude, for most target cities the balloons would only be in the field of view of one X-band radar (see Table 8-2).³⁵

For a North Korean attack on Los Angeles, the closest radar would be the one at Beale Air Force Base in Northern California (also to be deployed as part of the C-3 system) and the interceptors could be launched from either Alaska or North Dakota. For interceptors launched from North Dakota, θ would be approximately 25 degrees, whereas θ would be approximately 45 degrees for interceptors launched from Alaska. Thus, it would be to the advantage of the defense to use the interceptors launched from Alaska. At the closest intercept point to the radar at Beale, the altitude of the balloon would be 250 kilometers and the range to the radar would be 390 kilometers. In this case, the kill vehicle would again be unable to distinguish between balloons if ΔR were roughly 10 meters or less.

³³ For attacks from Iran or Iraq against Los Angeles, the closest X-band radar would be the one at Beale, California. For interceptors from Alaska or North Dakota, θ would be roughly 50 degrees. At the closest intercept point to the radar, the balloons would be at an altitude of 250 kilometers, and the range to the radar would be roughly 470 kilometers. In this case, position confusion could occur if ΔR were roughly 10 meters or less.

³⁴ For attacks from Iran or Iraq against Chicago, the closest X-band radar would be the one at Grand Forks, North

Dakota (to be deployed as part of the C-3 system). For interceptors from Alaska, θ would be roughly 30 degrees; and for interceptors from North Dakota, θ would be zero degrees, so interceptors from Alaska would have a better viewing angle. For an intercept at an altitude of 150 kilometers, the range to the radar would be roughly 1,000 kilometers. In this case, position confusion could occur if ΔR were roughly 40 meters or less.

³⁵ Adding a laser range-finder to the kill vehicle could address the problem somewhat. (While there are currently no plans to do this, the possibility has been discussed. See Sirak, "A C1 to C2 Move.") Doing so would allow the kill vehicle to make better use of the range information from the radar to reduce position ambiguities. For example, this would be the case if the kill vehicle and radar line-of-sights were parallel or antiparallel ($\theta = 0$ or 180 degrees). However, we find that potential ambiguities would still exist for a range of angles θ , and that even with the additional information provided to the kill vehicle by a laser range-finder, it would be very difficult if not impossible for the defense to pass an adequate map for a large cluster of closely spaced objects.

Chapter 9

Emerging Missile State Countermeasure 3: A Nuclear Warhead with a Cooled Shroud

If a nuclear warhead were covered with a metal shroud cooled to a low temperature, then the range at which the infrared sensors on the kill vehicle could detect the warhead would be reduced. If the warhead is cooled to a low enough temperature, then the detection range can be reduced enough so that even if the kill vehicle is able to detect the warhead, it would not have enough time to maneuver to hit it.

As we discuss below, a thin metal shroud that is cooled by liquid nitrogen to a temperature of 77 K would be straightforward to implement above the atmosphere. The level of technology required for such a cooled shroud is very low relative to that required to build a long-range missile or a nuclear warhead. Such shrouded warheads would prevent hit-to-kill homing by exo-atmospheric interceptors using infrared seekers and would thus defeat the planned US National Missile Defense (NMD) system.

The Design Details

Liquid nitrogen boils at the low temperature of 77.4 Kelvin (K) (−196 degrees Celsius). A metal shroud in contact with liquid nitrogen will thus remain at about 77 K until all the nitrogen has boiled away. Liquid nitrogen is widely used in research and engineering applications to maintain materials at a low temperature and is readily available (it can be produced by cooling air, which is about 78 percent nitrogen).

A warhead shroud that could be cooled to liquid nitrogen temperature could readily be made from aluminum. A simple design would be a double-walled cone-shaped shroud containing liquid nitrogen coolant in the cavity between the inner and outer walls. Since the warhead would give off heat, the designer would thermally isolate the warhead from the shroud to minimize the heat transfer to the shroud. The shroud could

be attached to the warhead with pegs made of a material with low thermal conductivity, such as Teflon.

Multilayer insulation would be placed in the gap between the warhead and shroud to greatly reduce the heat transfer by radiation from the warhead to the shroud. Multilayer insulation, sometimes referred to as “superinsulation,” consists of many layers of metallized plastic (such as thin sheets of mylar with aluminum evaporated onto the surface) with very thin spaces between the layers. (To the human eye, it appears similar to aluminum foil.) Multilayer insulation is available commercially and is a very effective insulator.¹

A first generation nuclear warhead deployed by an emerging missile state would likely be large. We assume here that such a warhead could be contained in a cone with a base diameter of one meter and a height of three meters. The shroud would then be slightly larger than the warhead, which would be inserted through the open back end of the shroud.

Within this design concept, there would be many design choices available to the engineers building a shrouded warhead. For this discussion, we will assume that a pressure release valve in the base of the shroud would be used to control the gas pressure between the walls of the shroud as liquid nitrogen boils off into gas. One side of the pressure release valve would be attached to a tube that vents expended nitrogen gas through the shroud-base to space. To prevent this venting gas from producing a thrust, a simple T-shaped outlet nozzle could be used. The net force from gas leaving one end

¹ The highly reflective metallized surfaces reduce the heat transfer by radiation with an effectiveness that increases geometrically with the number of layers. Multilayer insulation is punctured with many small holes to permit air to escape quickly in a vacuum, and the vacuum between layers greatly reduces heat transfer by conduction.

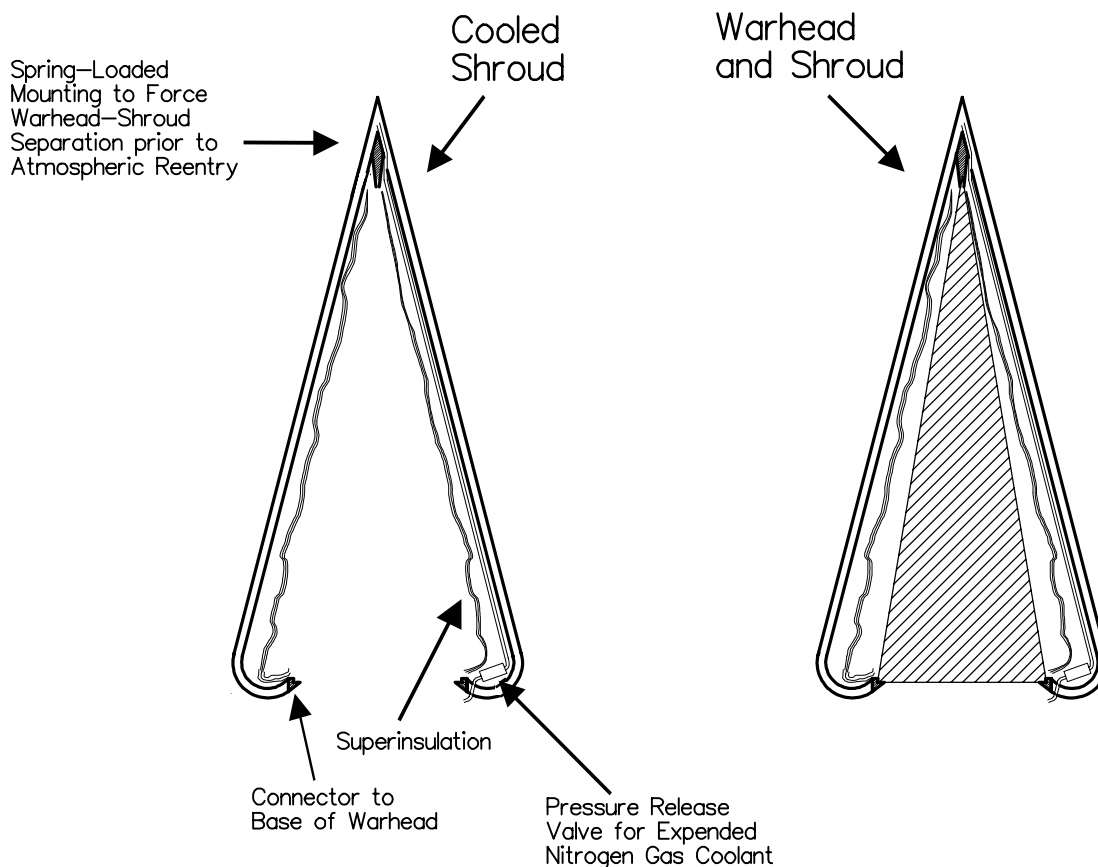

Figure 9-1. Schematic diagram of liquid-nitrogen cooled shroud.

of the T opening would be offset by the force from gas leaving the opening that points in the opposite direction. The other side of the valve is connected to a tube that transfers expended gas-phase nitrogen coolant from the shroud nose area. A schematic of such a cooled shroud is shown in Figure 9-1.

For this design, when powered flight was completed, standard techniques would be used to deploy the shrouded warhead so that it would be spin stabilized, rotating slowly around its axis of symmetry, and oriented in the desired direction. We discuss later in this chapter what orientations the attacker could use to control reflected infrared radiation from the Earth. The 1999 NIE concludes that countermeasure technologies such as “separating RVs, spin-stabilized RVs, and RV reorientation” are “readily available” to countries such as North Korea, Iran, and Iraq.

Since the shroud would be attached to a rotating stabilized warhead, centrifugal forces would confine the liquid-phase nitrogen coolant to the outer and lower regions of the shroud (see Figure 9-2). There would only be gas-phase nitrogen coolant in the tip of the shroud—where gas would be released through an alu-

minum tube connected to the pressure release valve in the base of the shroud. This design would therefore avoid the complicating problems of dealing with mixed phases of liquid nitrogen and gas in an environment with no gravity.

The shroud could be designed so that it could be removed from the warhead prior to reentry by a spring-loaded device or small gas generator behind the shroud-nose, which would be activated by a timer. Such a separation process is shown in Figure 9-3.

As noted above, a reasonable estimate for the size of such a conical shroud would be a base diameter of one meter and a height of three meters. Thus, the inner and outer walls of the shroud would each have a surface area of approximately 5 square meters—for a total surface area of 10 square meters. If we assume the walls of the shroud are a generous 1.5 millimeters thick (roughly 1/16 of an inch), then an aluminum shroud (with a density of roughly 2.7 grams per cubic centimeter) will weigh some 40 kilograms.

Such a shroud would require at most a roughly equal weight of liquid nitrogen coolant (40 kilograms) to chill it from room temperature (300 K) to liquid nitrogen

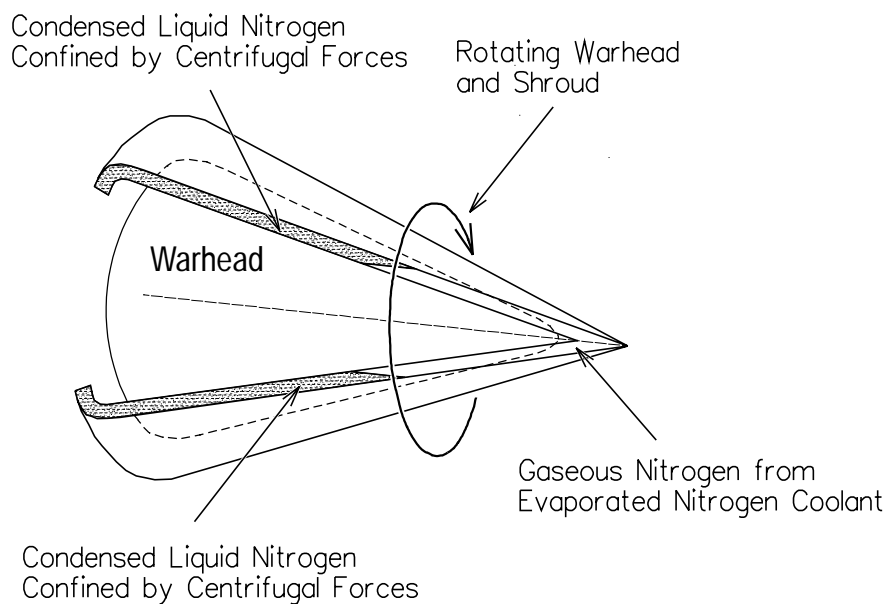

Figure 9-2. Spinning motion of warhead and shroud will confine liquid-phase nitrogen to outer and lower regions of the shroud.

temperature of 77 K.² As we calculate in Appendix I, about 200 grams of coolant per minute would then be required to maintain this temperature while the shroud is exposed to direct sunlight, sunlight reflected from the Earth, infrared radiation radiated by the Earth (earthshine), and heat radiated from the warhead through the superinsulation and the Teflon supports. Thus, about 6 kilograms of liquid nitrogen would be required to keep the shroud cool for 30 minutes, which is the flight time of an intercontinental-range ballistic missile. (If part or all of the warhead trajectory were not in sunlight, then less coolant would be required to maintain the shroud at a temperature of 77 K.) As we

² The specific heat of aluminum at room temperature is approximately 900 J/kg-K (Ray E. Bolz and George L. Tuve, eds., *Handbook for Tables of Applied Engineering Science*, Cleveland, Ohio: The Chemical Rubber Company, 1970, p. 96). Thus, to cool a shroud weighing M kilograms from a temperature of 300 K to 77 K would require $(900)(223) M = 2 \times 10^5 M$ joules. Since the heat of vaporization of liquid nitrogen is approximately 2×10^5 J/kg (ibid., p. 74), then the amount of liquid nitrogen required to cool the shroud would be M . However, this calculation somewhat overestimates the amount of nitrogen required, since it neglects the decrease in the specific heat of aluminum as the temperature is decreased as well as any cooling effect of the gas-phase nitrogen. For example, the specific heat of aluminum at 77 K is about 330 J/kg-K (Y. S. Touloukian and E. H. Buyco, *Thermophysical Properties of Matter, Volume 4: Specific Heat—Metallic Elements and Alloys* (New York: IFI/Plenum, 1970), pp. 1–3.)

discuss below, the attacker would likely choose to use cooled shrouds on trajectories that are partially or completely in the Earth's shadow; for a trajectory completely in the Earth's shadow the amount of nitrogen required to maintain the shroud at 77 K would be about one kilogram.

For this discussion, we will assume that the attacker would begin to cool the shroud only after the missile was launched and was above the atmosphere in the vacuum of space. Although it would be possible to cool the shroud prior to launch, by waiting until the war-

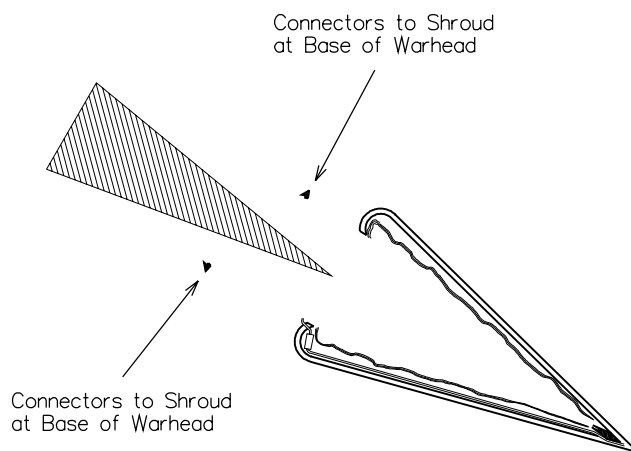

Figure 9-3. Prior to reentry, the shroud could be separated from the warhead using a spring-loaded device.

head is above the atmosphere, the attacker would avoid any potential problems associated with water freezing on the inside and outside of the shroud.³ Once the warhead is above the atmosphere, the liquid nitrogen could be pumped into the space between the two walls of the shroud using gas pressure or a small pump. Until then, the nitrogen could be stored in a flat, cylindrical tank attached to the bottom of the warhead. While it would

³ If the attacker wanted to cool the shroud prior to launch, in order to prevent water from freezing on the shroud, the attacker would need to control the humidity in the warhead environment while the warhead remained in the atmosphere. One way to do so would be to house the warhead in an aerodynamic fairing flushed with or containing dry nitrogen.

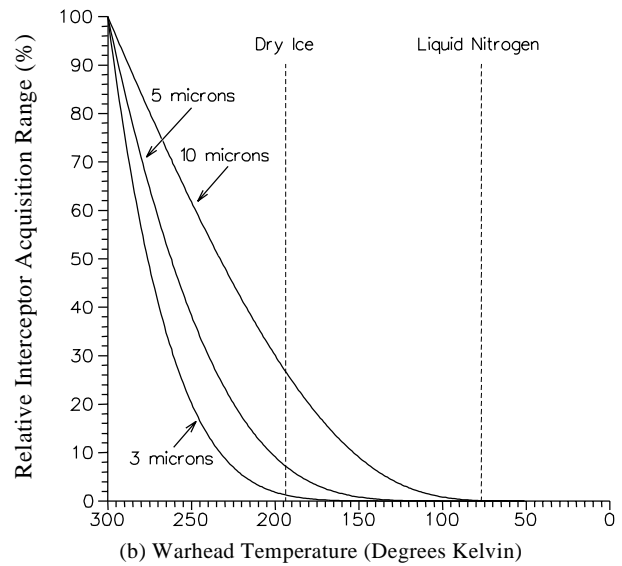
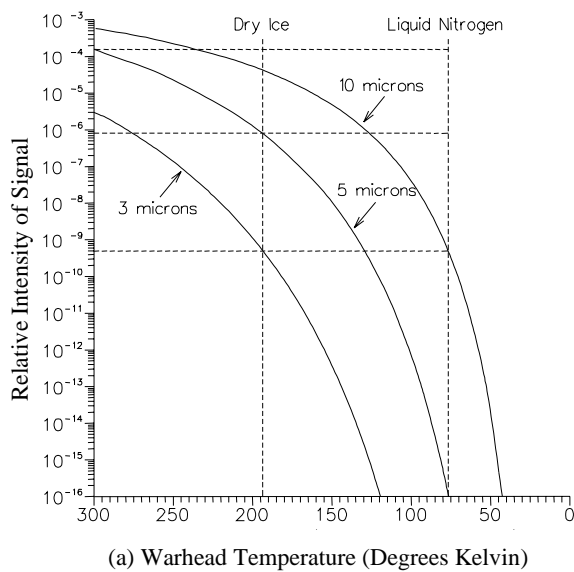

Figure 9-4. (a) Relative emission of a blackbody at three different wavelengths as a function of its temperature (b) The detection range as a function of warhead temperature, relative to the detection range of a warhead at room temperature.

take some minutes for the shroud to cool down to 77 K, it would be fully cooled before an interceptor could reach the shrouded warhead. (Although the SBIRS-low sensors would be able to detect the shrouded warhead until it had cooled somewhat, this would not help the defense.)

The total amount of liquid nitrogen needed to cool the shroud down to 77 K and maintain it at that temperature would be less than 46 kilograms, or about 58 liters of liquid nitrogen. This amount of liquid could be contained in a double-walled tank with a base diameter of 1 meter (to match that of the warhead) and a height of 8 centimeters. If made from 1.5-millimeter-thick aluminum, such a cylinder would weigh about 14 kilograms.⁴ Thus, the total weight of the shroud, the liquid nitrogen coolant, and the nitrogen storage container would be roughly 100 kilograms. This would add about 10 percent to the payload for a first generation warhead weighing 1,000 kilograms. Thus, an existing missile could deliver a shrouded warhead of the same weight to a somewhat shorter range or a somewhat smaller and lighter warhead to the same range. For example, a missile that could carry an unshrouded warhead weighing 1,000 kilograms to a range of 12,000 kilometers could instead deliver a shrouded warhead to a range of roughly 10,000 kilometers.

⁴ The surface area of a cylinder with a base diameter of 1 meter and a height of 8 centimeters is roughly 18,000 square centimeters. Aluminum has a density of 2.7 grams per cubic centimeter.

Reduced Infrared Detection Range

The exact wavelength of the radiation that the infrared sensors on the kill vehicle will use is not publicly known. However, sensor arrays that detect infrared radiation at wavelengths of 3 to 5 microns (μm) that would be suitable for use on a kill vehicle are currently available, and sensor arrays that operate at a wavelength of 10 microns may now be available or may become available in the future. A shrouded warhead at liquid nitrogen temperature would radiate a 5-micron infrared signal roughly a trillion times (10^{12}) less intense than that of an unshrouded warhead (see Figure 9-4a). This means that if a kill vehicle's 5 μm sensor allowed it to begin homing on a room temperature warhead at a range of 1,000 kilometers,⁵ it could only begin to home against a warhead with a cooled shroud at a range of about one meter! As Figure 9-4a shows, even if the NMD kill vehicle uses a sensor that can operate at a wavelength of 10 microns, the signal from the cooled shroud would be roughly a million times (10^6) less intense than that from an unshrouded warhead. In this case, the kill vehicle acquisition range would be reduced from 1,000 kilometers to 1 kilometer.

⁵ This detection range may be generous to the defense. For the second sensor fly-by test, the Raytheon kill vehicle reportedly acquired the targets at a range of 700–800 km. (William B. Scott, "Data Boost Confidence in Kill Vehicle Performance," *Aviation Week and Space Technology*, 8 June 1998.)

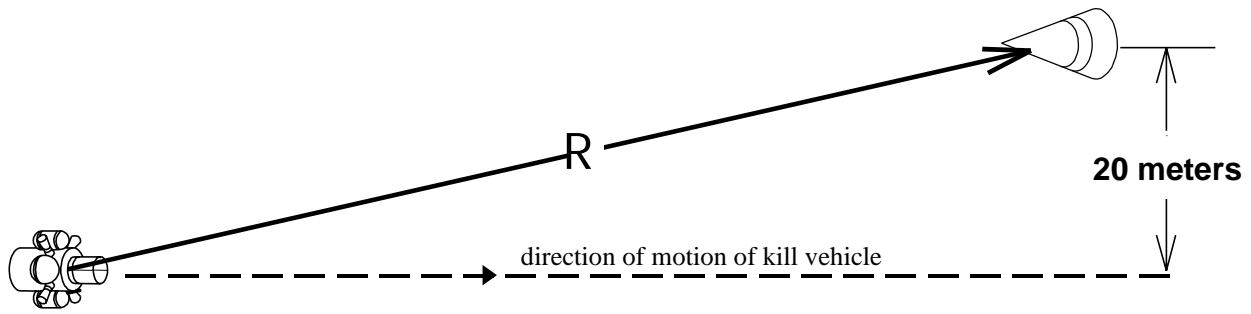

Figure 9-5. Assumed intercept geometry. Here the kill vehicle is moving in the horizontal direction to the right. When the kill vehicle first detects the warhead at a range R , we assume the lateral miss distance would be only 20 meters if the kill vehicle did not maneuver.

The implications of such a reduction in kill vehicle acquisition range are dramatic, as shown in Table 9-1. We assume that the NMD system—using data from the ground-based radars and SBIRS-low—is able to guide the interceptor booster to its basket with near perfect precision. Thus, we will assume that the lateral miss distance the kill vehicle would have to correct for once it acquires the target is only 20 meters. (See Figure 9-5).

An interceptor that begins to home on its target at a range of 1,000 kilometers will have roughly 100 seconds to maneuver laterally if the target and interceptor have a closing speed of 10 kilometers per second. Under these conditions, a lateral movement of 20 meters would require only a very small average lateral acceleration of 0.0004 g (where g is the acceleration due to gravity, which is approximately 10 m/sec^2). This is easily managed by the kill vehicle, which would likely

have a lateral acceleration capability of a few tens of g s.⁶ However, if the kill vehicle instead detects the target at a range of only 1 kilometer, the required average lateral acceleration would be 400 g , well beyond the capability of the kill vehicle, even assuming the interceptor responds instantaneously after detecting the target.

If the shrouded warhead reduces the kill vehicle detection range to even several kilometers, for all practical purposes the probability of an intercept will be reduced to zero. With infrared sensors that detect radiation of 3–5 microns, the detection range would be reduced to about a meter; for 10-micron sensors, the detection range will only be about a kilometer. In either case, it is clear that the kill vehicle will have no chance of intercepting the target.

Detection Using Reflected Radiation

In addition to an infrared signal radiated by the shrouded warhead, there may also be a signal from infrared radiation or visible light that is reflected off the shroud. Such reflections from the shroud could be due to visible light coming directly from the sun or from sunlight that is reflected off the Earth. Since the Earth is an intense emitter of infrared radiation, the shroud could also reflect infrared radiation from the Earth. However, as we will show, an attacker can take measures to

Table 9-1. The average lateral kill vehicle acceleration required for the kill vehicle to hit the target as a function of kill vehicle detection range (labeled “ R ” in Figure 9-5).

We assume a closing speed of 10 km/sec, and a lateral miss distance of 20 meters at kill vehicle acquisition.

Interceptor Acquisition Range	Closing Time	Average lateral interceptor acceleration required ($g \approx 10 \text{ m/sec}^2$)
1,000 kilometers	100 seconds	0.0004 g
100 kilometers	10 seconds	0.04 g
10 kilometers	1 seconds	4 g
1 kilometer	0.1 seconds	400 g

⁶ Based on the kill vehicle’s mass and fuel, we estimate its total ΔV to be about 1 km/sec. If we assume that it must have enough fuel for 10 seconds of thrust, the average acceleration would be 10 g .)

essentially eliminate the possibility that the kill vehicle could home on these signals.

Reflected Infrared Radiation. If the cooled shroud reflected all the Earth's infrared radiation that impinged on it, then the reflected infrared radiation would be comparable in intensity to that emitted by a warhead at room temperature.⁷ Since the infrared absorptivity of aluminum is 0.03, the shroud would reflect almost all the infrared radiation that strikes it. If some of this radiation were reflected toward the kill vehicle, it might be adequate to permit the kill vehicle to home on it. However, a shroud made of polished aluminum would be a specular reflector. Like a mirror, it would reflect radiation at the same angle relative to the surface of the shroud that the incident radiation strikes the shroud.⁸ As a result, for the type of shroud we consider here, there would be a broad range of directions into which the shroud will reflect no infrared radiation from the Earth.

To see this, consider a shroud with half-angle α at an altitude h above the Earth's surface and pointed straight down toward the Earth. In this case, it is straightforward to show that this shroud would not reflect radiation into a conical volume of half-angle θ , where

$$\theta = 180 - 2\alpha - \arcsin[R_e/(R_e+h)] \text{ degrees} \quad (9-1)$$

and R_e is the radius of the Earth (6,370 kilometers). This region lies below the warhead and is symmetric around the vertical direction. For a shroud with a base diameter of 1 meter and a height of 3 meters, the half-angle α would be 9.5 degrees. The region of no reflections would change with altitude since the angle at which radiation approaches the warhead from the Earth depends on altitude. For example, at an altitude h of 370 kilometers, the half angle θ would be 90 degrees and no infrared radiation would be reflected into the half space below the shroud, bounded by a horizontal flat plane. For a warhead at an altitude of 1,000 kilometers, the half angle θ would be 101 degrees (in this case, it is easier to think of the infrared radiation being reflected into a cone of half-angle $180 - 101 = 79$ degrees, with the tip of the cone pointing down toward

the Earth. For a warhead at 130 kilometers—the goal for the minimum intercept altitude of the NMD kill vehicle—the half-angle θ would be 82 degrees.

By tipping the shroud so that its axis is no longer vertical, the attacker could shift the orientation of the region of no reflected infrared radiation. In particular, the region could be rotated up so that it was no longer symmetric around the vertical and more of its volume faced in directions from which an interceptor might approach. Detailed calculations show that the shape of the region would distort somewhat from conical, but the region would remain very broad for tip angles of a few tens of degrees. For example, Figure 9-6 shows the boundary of the region of no reflection for a case in which the warhead is at an altitude of 1,000 kilometers and the axis of the warhead is rotated 10 degrees from the vertical. The warhead will reflect infrared radiation from the Earth only into directions lying in the region above this surface. When releasing the warhead

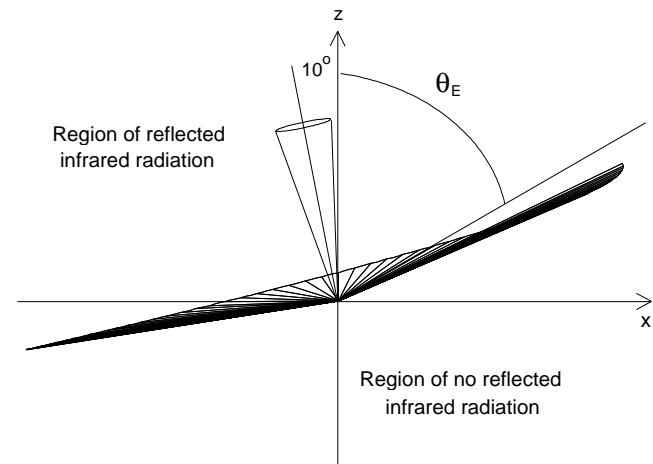

Figure 9-6. The region of no reflection for a tipped warhead.

This figure assumes the warhead is at an altitude of 1,000 kilometers, and the axis of the warhead has been rotated around the y-axis by 10 degrees from the vertical. The warhead will reflect infrared radiation from the Earth into those directions lying in the conical region above the surface shown.

At this altitude, a kill vehicle looking down at the warhead at angles less than $\theta_e = 59.8$ degrees from the vertical would see the earth rather than space as a background.

Along the positive x-axis, the lower boundary of the region of no reflection lies at an angle that is less than 5 degrees greater than θ_e . Thus, a kill vehicle approaching the warhead from the right side of the figure would be able to see reflected radiation against a space background only if its direction of approach happened to fall within this narrow range of angles. This range of angles could be further reduced by using a tipping angle greater than 10 degrees.

⁷ The Earth infrared flux is about 240 W/m², and a 300 K blackbody emits about 280 W/m² over the 3 to 16 μm band.

⁸ The attacker could easily cover the shroud with a thin layer of another material, such as polished gold, if it was concerned that the surface of the aluminum might not be sufficiently specular.

from the missile after boost phase, the attacker could orient the warhead to point the region of no reflection toward the directions from which interceptors would be approaching as they neared the warhead. The 1999 National Intelligence Estimate noted that emerging missile states must be expected to be able to spin stabilize warheads, which would allow such orienting.⁹ Since the region of no reflection is very broad, the attacker would not need to orient the shroud with high precision.¹⁰

Reflected Visible Light. Although the kill vehicle will have a visible sensor to aid in target detection, as the system is currently configured, the final homing (during the last tens of kilometers) must be done using the infrared sensors.¹¹ In this case, any visible light reflected from the shroud could not be used to home on the warhead. We do not know if the current design can be modified to permit final homing using the visible sensor, but to eliminate the chance that the kill vehicle could home on visible light reflected from the shrouded warhead, the attacker can simply choose to attack at night (or more precisely, when the missile's trajectory would be in the Earth's shadow), much as Iraq chose to launch nearly all of its Scud missiles at night during the Gulf War. Since the attacker would presumably initiate the conflict with the United States, it would have considerable flexibility in choosing the timing of the attack.

⁹ National Intelligence Council, "National Intelligence Estimate (NIE): Foreign Missile Development and the Ballistic Missile Threat to the United States Through 2015," unclassified summary, September 1999, p. 16.

¹⁰ Even if the kill vehicle approached the warhead so that it viewed the warhead against the background of the Earth, the warhead would not be detectable as a cold spot against the warm Earth background. Until the kill vehicle was close to the warhead, the warhead would fill only a small fraction of a pixel on the kill vehicle seeker array, and thus would not produce a detectable reduction in the Earth background seen by that pixel. For example, if the seeker had a one-degree field of view and a 256 x 256 seeker array, a warhead would only fill about 2 percent of a pixel at a range of 100 kilometers and about 10 percent at a range of 50 kilometers (which would be about 5 seconds before a possible intercept).

In addition, at all angles of approach over which the kill vehicle could view the warhead against the Earth background, the warhead would reflect earthshine toward the kill vehicle. As Figure 9-6 shows, for a warhead at an altitude of 1,000 kilometers, a kill vehicle looking down at the warhead at angles less than $\theta_E = 59.8$ degrees from the vertical would see the Earth rather than space as a background. Since the warhead reflects into those direc-

Since the Earth's axis of rotation is inclined 23 degrees relative to the Earth's orbital plane, an emerging missile state would be able to attack some cities using trajectories that are entirely in the Earth's shadow at only certain times of the year, whereas other cities could be attacked year round using such nighttime trajectories. However, the entire trajectory would not need to be in the Earth's shadow, only the part where an intercept could occur.

For example, Figure 9-7 shows that in midwinter, North Korea could attack the entire United States using trajectories that are never sunlit, although attacking the east coast would require it to use trajectories that are depressed slightly below normal (about a 17-degree, rather than a 23-degree, loft angle).

Flying missiles on the kinds of modestly depressed trajectories considered here would not be difficult for a country that had a missile capable of flying on standard trajectories. Atmospheric forces during boost phase are not a problem since the missile can be flown on a standard trajectory until it is high enough that the atmospheric density is low and can then be turned onto a depressed trajectory.¹² Indeed, in its 31 August 1998 missile test, North Korea successfully launched its missile onto a significantly depressed trajectory.

Since the reentry vehicle on a depressed trajectory travels a longer path through the atmosphere during reentry, there are two other potential concerns: that the accuracy will degrade and that additional heating may be a problem. However, missiles deployed by emerging missile states would have very poor accuracy even on a standard trajectory, and the additional loss of accuracy would not be significant. Moreover, detailed calculations show that heating would also not be a problem.¹³

tions, this would further reduce the possibility that the kill vehicle could detect the warhead as a cool spot against the warm earth background.

¹¹ In the 18 January, 2000 intercept test, the kill vehicle failed to hit its target because the infrared sensors were not functioning properly. In this test, the final homing began at 6 seconds before the predicted impact time, and the closing speed between the kill vehicle and the mock warhead was 6.7 kilometers per second (Defense Department Background Briefing on Upcoming National Missile Defense System Test, 14 January 2000). Thus, the final homing—to be performed by the infrared sensors—began at a distance of roughly 40 kilometers from the target.

¹² This is discussed in detail in Lisbeth Gronlund and David Wright, "Depressed Trajectory SLBMs," *Science and Global Security*, Vol. 3, 1992, pp. 101-159.

¹³ Calculations of reentry heating were conducted on 10,000-kilometer-range trajectories with reentry angles of

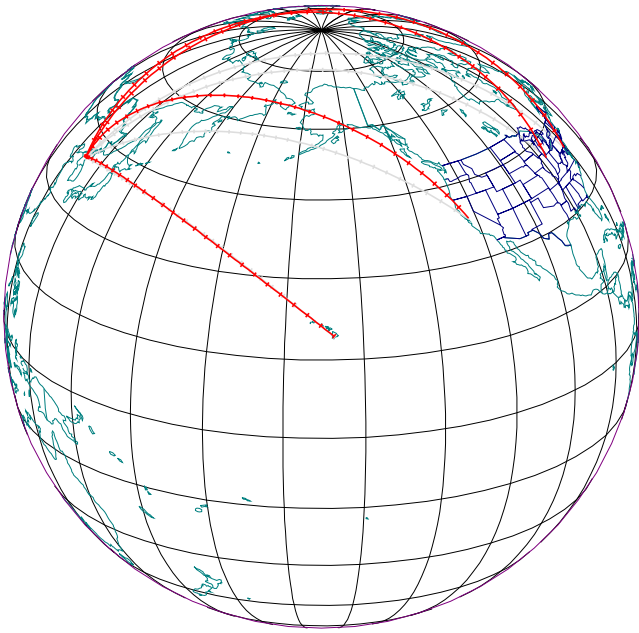

Figure 9-7. Trajectories from North Korea to New York, Chicago, San Francisco and Hawaii during midwinter (23 degree Earth inclination).

This shows the night side of the Earth (viewed from the same distance as the sun). This figure demonstrates that at this time of year all of these cities could be attacked by North Korea on trajectories that were entirely in the Earth's shadow. Keeping the trajectory to New York entirely in the Earth's shadow would require depressing its trajectory to a loft angle of 17 degrees. (The gray curves under the trajectories show the ground tracks of the missile.)

Finally, we note that the modest depressions of trajectories we consider here would lead to minimal loss of range.¹⁴

Figure 9-8 shows that during midspring or midfall, the west coast of the United States, as well as Hawaii and Alaska, could be attacked by North Korea on trajectories that are never sunlit, although a slight depression (20-degree loft angle) would be needed for the west coast.

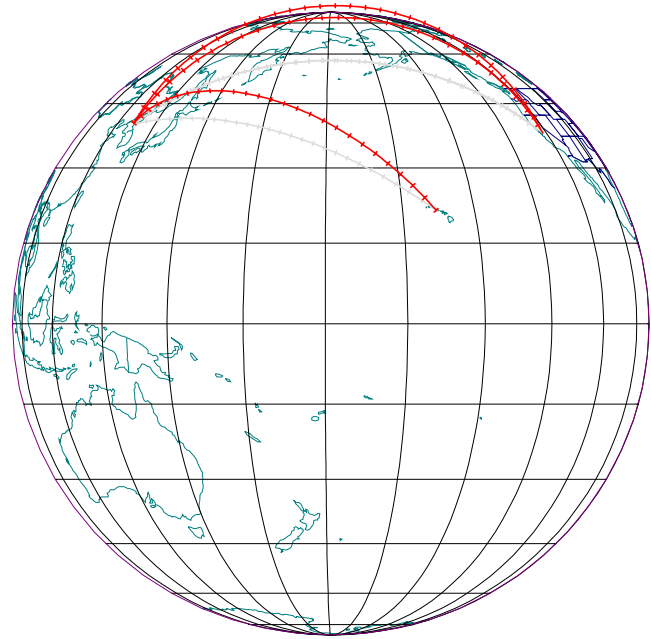

Figure 9-8. Trajectories from North Korea to San Francisco and Hawaii during midspring and midfall (zero degree Earth inclination).

Two trajectories are shown for San Francisco, one at a standard loft of 23 degrees (which will be partially sunlit), and one slightly depressed to a loft angle of 20 degrees (which would be entirely in the Earth's shadow).

Figure 9-9 shows that with some depression of trajectory (roughly a 19-degree loft angle), North Korea could attack Hawaii on a trajectory that is not sunlit even in midsummer.

Thus North Korea could attack Hawaii on nonilluminated trajectories at any time of year. With some depression of the trajectories, North Korea could attack San Francisco for more than six months a year, and North Korea could even attack Washington, D.C., on a nonilluminated trajectory by using a more depressed trajectory (15-degree loft angle) for about one month a year during midwinter.

20° and 15°, and were compared to similar calculations on a standard, minimum-energy trajectory of the same range with a reentry angle of 23°. (These calculations used the method described in Appendix F.) The peak heating rate and total heat absorbed per area were calculated at the nose of the RV and on the wall of the RV at a point one meter behind the nose. These calculations show that the peak heating rates are actually less on the depressed trajectories than on the standard trajectory (by approximately 4% and 15% at the nose for the 20° and 15° cases, respectively, and by approximately 8% and 24% on the wall of the RV) since the RV's speed on the depressed trajectories is lower at the altitudes of peak heating. The total heat

absorbed is somewhat higher on the depressed trajectories (by approximately 7% and 24% at the nose for the 20° and 15° cases, respectively, and by approximately 4% and 9% on the wall of the RV), since the duration of heating is somewhat longer. An emerging missile state could easily accommodate these increases by a modest thickening of the heat shield.

¹⁴ Flying a missile with a maximum range of 10,000 kilometers on a depressed trajectory with a reentry angle of 20° rather than a standard trajectory with a reentry angle of 23° would only reduce the range by a few tens of kilometers, or by a few hundred kilometers for a trajectory with a reentry angle of 15°.

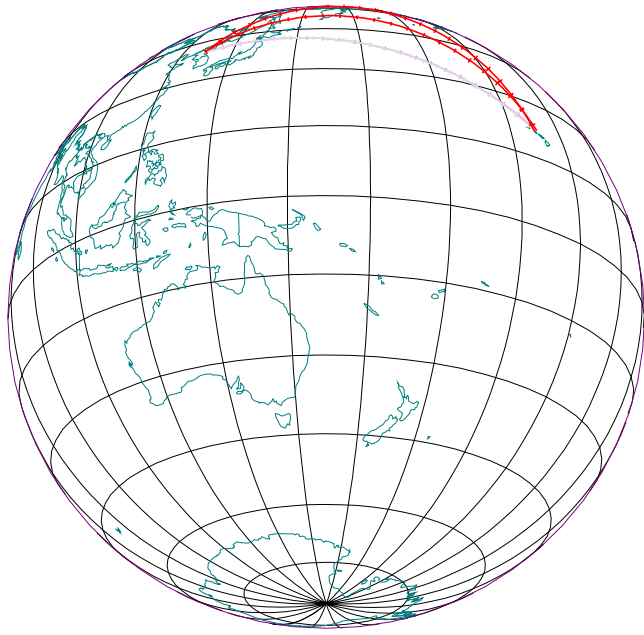

Figure 9-9. Trajectories from North Korea to Hawaii during midsummer (23 degree Earth inclination). Two trajectories are shown.

A slightly depressed trajectory with a 20-degree loft angle will be briefly sunlit, while one with a smaller loft angle of 15 degrees will never be sunlit.

Figure 9-10 shows that Iran or Iraq could attack Washington, D.C., on trajectories that are not sunlit in midfall or midsummer, using standard trajectories (23-degree loft angle). With some depression of trajectories, these countries would be able to attack Washington, D.C., on trajectories that are not sunlit at least 8 months out of 12.

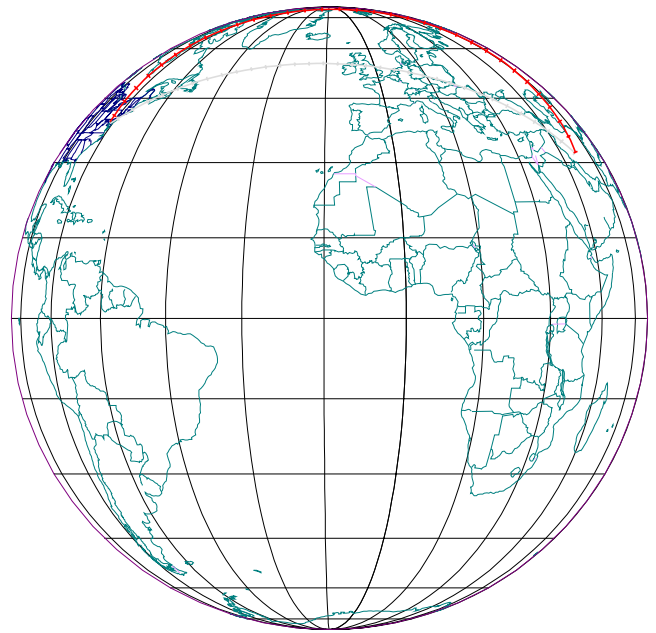

Figure 9-10. Trajectory from Iran to Washington, D.C., during midfall or midspring (zero degree Earth inclination).

A standard (loft angle of 23 degrees) trajectory will never be sunlit.

Reflected moonlight could, in principle, also be a source of visible light, although it is unlikely that this source is bright enough to be exploited by a homing kill vehicle.¹⁵ However, if an attacker is sufficiently concerned about this source of illumination, timing the launch so that the moon is also below the horizon would address this concern.

¹⁵ The full moon is about 1/400,000 as bright as the sun, so its flux is about 0.0034 W/m². MSX's visible sensor (Appendix B) is said to be able to detect targets with reflectivity-area products of 0.1–0.35 m² viewed against a dark space background at ranges of "several times" 6,000 km. Since the kill vehicle's detection capability is likely to be at least several times poorer, assume it would be 6,000 km against such targets. If illuminated by full moonlight, this would correspond to a detection range of about 10 km. Thus we can make a very rough estimate of the kill vehicle's visual detection range as ranging from about 10 km for a very high emissivity (low reflectivity) shroud to about 30–40 km for a low emissivity shroud.

Chapter 10

Testing the NMD System: Requirements and Recommendations

This study finds that the planned NMD system can be defeated by a limited ballistic missile attack using simple countermeasures such as those described in Chapters 7–9, and that such countermeasures must be expected to form a part of any threat from emerging missile states. If the planned NMD system cannot deal with these countermeasures, it makes no sense to deploy it. If the Pentagon believes the planned NMD system can deal with such countermeasures, the burden of proof is on it to demonstrate that capability in a rigorous testing program, before a deployment decision is made. A rigorous testing program that incorporates realistic countermeasures is the only way to assess the operational effectiveness of the planned NMD system.

In the Chapter 11 we review past US ballistic missile defense tests that have included decoys or other countermeasures and show that none of these demonstrated an ability to discriminate the warhead from decoys or to otherwise defeat countermeasures.

In this chapter we first discuss how the US government tests its military systems, and what some of the criteria are that determine how many and what kind of tests are needed to assess operational effectiveness. We then discuss the difficulties inherent in testing a system that will face countermeasures in the real world and the important role of “red team” efforts to develop countermeasures using the technology and information that would be available to emerging missile states.

Next, we discuss the operational requirements for the NMD system and the planned testing program. We find that, as currently structured, this testing program will not provide US planners with a basis for knowing what the operational effectiveness of the NMD system will be before it is deployed. To assess the effectiveness of any military system, field tests must be conducted under a variety of conditions that approximate

as closely as possible those expected in the real world, and enough tests must be conducted to permit some confidence in the results. Neither of these conditions will be met under the flight tests planned before deployment of the NMD system, much less before the decision about deployment scheduled for fall 2000.

Finally, we make recommendations about how the NMD testing program should be restructured to permit an assessment of the operational effectiveness of the NMD system against the threats it is intended to address. In brief, we recommend that the testing program:

- accurately define the baseline missile threat that the defense must be designed and tested against, making sure that it includes realistic countermeasures of the type discussed in this report
- conduct the right kind of tests, by ensuring that the testing program includes tests against the best countermeasures an emerging missile state could be expected to build
- conduct enough tests to determine the effectiveness of the system with high confidence
- provide for objective, independent assessment of the test design and results

Testing Military Systems

Every military system requires testing, and none more so than ballistic missile defense systems, which are subject to potentially devastating countermeasures. A good testing program makes extensive use of ground testing and simulation, but these cannot substitute for field tests of the system under realistic conditions.

A testing program begins with an “operational requirements document” (ORD), which describes in some

detail the system performance parameters that the users and program manager believe the system must have to justify its eventual procurement.¹ The ORD is a formal document that (ideally) specifies how the system will be used in the field and what the minimum and desired levels of performance would be.²

The specification of the threat that a weapons system is intended to counter is contained not in the ORD, but instead in the Systems Threat Assessment Requirement (STAR) document. The STAR defines the threat standard, that is, the threat or set of threats the system must operate against. The threat standard is validated and approved by the Pentagon's Defense Intelligence Agency, usually through intelligence gathered on a potential adversary's weapons systems.

The goal of the testing program is then to assess whether the military system meets the requirements set out for it. The testing program can be no better than the underlying requirements and STAR documents. If these documents do not accurately reflect the real world threat, the testing program will not be able to assess the operational effectiveness of the weapon system in the real world.

The STAR document for the planned NMD system is classified. However, the publicly available information strongly suggests it does not reflect the real world threat. In particular, the Ballistic Missile Defense Organization (BMDO) described the target suite used in the first two NMD intercept tests as "more than representative of the threat."³ Yet the countermeasures consisted of one balloon "decoy" with a very different infrared signature and radar cross section than those of the mock warhead. Moreover, the defense was told in advance what the characteristics of the warhead would be, so it could easily distinguish one from the other. In no way was this target suite representative—much less

"more than representative"—of the technically simple countermeasures that an emerging missile state could deploy.⁴

Within the Department of Defense is the office of the Director, Operational Test and Evaluation (DOT&E), which provides oversight of the testing programs for major military systems. The NMD system and the theater missile defense systems are included under its purview. DOT&E reports directly to the Secretary of Defense. Among other things, it writes an annual report to Congress on the testing programs of the military systems it oversees; an unclassified version is always available.⁵ For the most part, DOT&E operates in an advisory capacity. However, DOT&E must approve a Testing and Evaluation Master Plan (TEMP) for the each program, as must other development and acquisitions offices within the Defense Department. In addition, under current law, a major defense acquisition program may not go beyond a low rate of initial production (LRIP) until the DOT&E issues a report (called a "Beyond-LRIP Report") stating⁶

- whether the test and evaluation performed were adequate
- whether the results of such test and evaluation confirm that the items or components actually tested are effective and suitable for combat

However, the Secretary of Defense is free to ignore the conclusions of a "Beyond-LRIP Report."

Confidence Level and Effectiveness. Although the terms "confidence level" and "effectiveness" may seem redundant, both are needed to describe the required or expected performance of a system. Effectiveness is a measure of how well a system would work in the real world. The effectiveness of a system is not known a priori, and can be determined only through extensive testing or use of the system. (For a missile defense system the effectiveness is usually expressed as a "kill probability"—the probability that the defense will successfully intercept a warhead or several

¹ Definition from Michael L. Cohen, John E. Rolph, and Duane L. Steffey, eds., *Statistics, Testing, and Defense Acquisition: New Approaches and Methodological Improvements*, report by the Panel on Statistical Methods for Testing and Evaluating Defense Systems, Committee on National Statistics, Commission on Behavioral and Social Sciences and Education, National Research Council, (Washington D.C.: National Academy Press, 1998), p. 212.

² The requirements document is validated and approved by the Joint Requirements Oversight Council, which is chaired by the Vice Chairman of the Joint Chiefs of Staff and includes the Vice Chiefs of the Army, Navy, and Air Force, and the Assistant Commandant of the Marine Corps.

³ Michael C. Sirak, "BMDO: Only Three NMD Tests 'Likely' Before Next Year's NMD Review," *Inside Missile Defense*, August 25, 1999, pp. 13–14.

⁴ It is entirely reasonable to begin testing a new NMD system against mock warheads with no countermeasures and to work up to more sophisticated ones. It is the description of the first test target suite as representative of the threat that indicates the STAR document has greatly underestimated the countermeasures threat.

⁵ These reports are available online on the DOT&E website at www.dote.osd.mil.

⁶ Cohen et al., *Statistics, Testing, and Defense Acquisition*, p. 21.

warheads.) The confidence level describes how much trust the user has in what he or she believes the effectiveness of the system to be, based on prior testing and use. Put differently, effectiveness is an intrinsic property of the system, and testing is used to determine what the effectiveness is to a certain degree of confidence. Even if a military system were in fact highly effective, without adequate testing the United States would have very low confidence in its effectiveness and would not be able to assume it was highly effective.

Determining the effectiveness of a military system requires conducting “operational tests” that use production or near-production components. The tests done during the development of the system cannot be used to determine the effectiveness of the deployed system since they generally do not use production components. Moreover, any significant changes to the system made during operational testing would theoretically require a new round of tests.

The number of tests needed to determine the effectiveness of a military system will depend on the level of confidence that is required in that effectiveness, with more tests required to establish a higher level of confidence (see box). The number of tests required will also depend on several other factors, including⁷

- whether the system is new or is an upgrade or modification of an existing system
- the effect of a system failure, which can range from catastrophic (a total failure of the mission) to minor (results in inconvenience or additional cost)
- whether a mission failure would result in the loss of life
- how stressful the operating environment will be
- how unpredictable or varied the operating environment will be
- whether the system will meet opposition and what the nature of the opposition might be

Thus, a military system will require more operational testing if it makes use of new technology that has not been included in a similar system with a good operating or test record; if a system failure would result in a total mission failure or seriously degrade the chance of mission success; if a mission failure would

result in the substantial loss of life; and if the operating environment is expected to be stressful and varied because there will be opposition. A national missile defense has all these characteristics and should therefore be subject to extensive testing. In fact, a missile defense system would need to be tested in many different operating environments (to take into account different possible countermeasures), each of which would require its own separate set of tests to estimate the system’s performance under that environment. (This is in contrast to, for example, testing ballistic missiles, where the operating environment is predictable.)

However, in practice, it is generally expensive to test weapon systems that must undergo destructive testing (in which the weapon itself is destroyed in the test). For example, the Pentagon reported that the first NMD intercept test that took place on 2 October 1999 cost \$100 million.⁸ Thus, weapons systems that require destructive testing (for example, ICBMs and air and missile defenses) are often not tested enough before deployment to meet the requirements of high confidence in their effectiveness. For some of these systems, additional information will be gained through training and combat experience. However, this will not be possible for the NMD system; training will involve few, if any, real engagements with ballistic missile targets, and a ballistic missile attack on the United States will be a rare event so there will be no combat experience.

As an example of how the expense of destructive testing makes it difficult to perform the needed flight tests, a National Research Council report considers a missile system for which the planned deployment is 1,000 missiles.⁹ Under the assumption that the operational requirement is that the missile land within the lethal range of its target at least 80 percent of the time, and that the user have a 90 percent confidence level that this effectiveness would be met, roughly 148 missiles would need to be fired in destructive testing. Since these tests would consume 15 percent of the planned arsenal, the report states that such a testing program would almost certainly be challenged as an inappropriate allocation of defense resources.

If it is not possible to establish high confidence in high effectiveness for a missile defense interceptor through testing, it may be possible to compensate to some extent by using additional interceptors or adding

⁷ Cohen et al., *Statistics, Testing, and Defense Acquisition*, pp. 194–201.

⁸ Jonathan S. Landay, “Fallout from US Antimissile Success,” *Christian Science Monitor*, 4 October 1999, p. 1.

⁹ Cohen et al., *Statistics, Testing, and Defense Acquisition*, pp. 31–32.

additional systems that operate in different ways. In some cases, the defense can use shoot-look-shoot tactics so that additional interceptors are only used if the first ones fail. However, in some cases there will not be time for such assessment before firing additional interceptors or it may be difficult for the defense sensors to determine if the intercept was successful.

The Operational Requirements for the Planned NMD System

As we discuss in Chapter 3, the initial (Phase-1) stage of the planned NMD system is intended to defend against tens of “simple” warheads from North Korea, and perhaps five warheads from the Middle East. The final “capability-3” (C-3) stage is intended to defend against “many, complex” warheads. The dividing line

Effectiveness and Confidence Levels: An Illustration

A familiar example illustrates these concepts. Based on past experience, we can be very confident that the probability of getting heads when flipping a coin is 50%. Thus, our confidence level is essentially 100% that the “system effectiveness” is 50%, where in this example the “effectiveness” is the probability not of intercepting a warhead but of getting heads.

But what if we were handed a coin that was potentially weighted, so we did not know a priori what the odds of getting heads was? To determine the probability of getting heads, we would conduct a number of tests (in this case, coin flips). How many times we would flip the coin would depend on how confident we wanted to be of the probability of getting heads—the higher the level of confidence, the higher the number of required “tests,” or coin flips.

Suppose we flipped the coin 20 times and got 12 heads. Could we conclude from this result that the odds of getting a head on any subsequent coin flip was $12/20 = 60\%$? No, because for any set of flips we would expect to see some fluctuation about the actual probability of getting heads. Even if the coin were not weighted and the probability of getting a head were 50%, we would expect to see 12 heads in 20 flips about 12% of the time.

Figure 10-1 shows the probability distribution of seeing 12 heads in 20 flips for different values of p_h , the probability of getting a head in a single coin flip. While the distribution peaks at $p_h = 60\%$, it is so wide that the results give little confidence that 60% is the actual value of p_h . In fact, the results give us a 90% confidence level that the true value of p_h lies between 45% and 75% (that is, that the odds of getting a head in any coin flip is between 45% and 75%), but only a 39% confidence level that the value of p_h lies between 55% and 65%. Thus, after 20 tests, we could not say whether or not the coin was weighted with much confidence.

Now suppose we keep flipping the coin for a total of 200 times and find 120 heads. The probability distri-

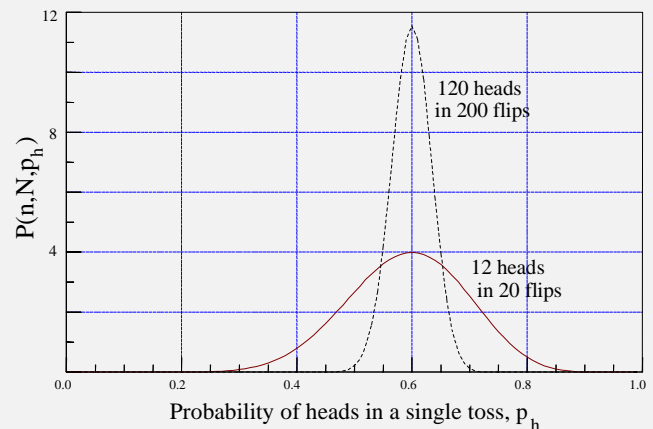

Figure 10-1: Probability distributions for 20 flips and 200 flips.

These curves show the probability distribution $P(n, N, p_h)$, which is proportional to $(p_h)^n(1-p_h)^{N-n}$, for two specific cases. $P(n, N, p_h)dp_h$ is the probability of getting n heads in N flips if the probability of getting a head on any single flip lies between p_h and p_h+dp_h . If someone flipped a coin N times and got n heads, then the area under the curve between two values of p_h is a measure of the confidence that the true value of p_h lies within that interval. We consider the cases: $n=12$ heads in $N=20$ flips, and $n=120$ heads in $N=200$ flips. For example, the solid curve shows the probability distribution of getting 12 heads in 20 flips for different values of p_h .

bution still peaks at 60% (see Figure 10-1) but is now much more narrow, reflecting the fact that statistical fluctuations become less significant as the number of tests increase. Based on these results, we would have an 85% confidence level that the value of p_h lies between 55% and 65%, and less than 8% confidence that it lies between 45% and 55%. Thus, at this level of testing, we would have considerable confidence that the coin was weighted, and that the probability of getting a head for any coin flip was near 60%.

between the terms “simple” and “complex” is not well-defined (at least publicly); these terms refer to the extent to which the attacker has incorporated countermeasures to fool or overwhelm the defense, and the sophistication of those countermeasures.

Although the NMD operational requirements document is classified, the confidence and effectiveness levels required are reportedly “a 95% confidence level that a 95% kill probability will be achieved.”¹⁰ In other words, the user must be 95% confident that the system will be 95% effective against a limited attack.

The Pentagon plans to attain a 95% kill probability by firing multiple interceptors at each target using a “shoot-look-shoot” strategy. One strategy would be to fire two interceptors at the target, look, then fire another two.¹¹ Reportedly, the NMD designers “expect roughly an 85% probability of kill from a single shot.”¹² If the failure modes of the four interceptors are independent of one another, then the United States would have 95% confidence that firing four interceptors at each target would give a 95% probability of kill. We consider both of these assumptions below.¹³

Determining the Single-Shot Kill Probability. We first note that an interceptor cannot be described by a single value of the single-shot kill probability, since the probability of interception will depend on the situation. The kill probability will depend on a number of factors, such as the geometry of the intercept, where the attacking missile is coming from, the time of day the attack occurs (since that will change the infrared

and visible signal of the warhead), and whether the attacker uses countermeasures.

Thus, the single-shot kill probability is meaningless unless the conditions under which it is expected to apply (and under which it was determined) are specified.

Moreover, the single-shot kill probability for an interceptor cannot be known or asserted a priori—it must be determined through testing.¹⁴ Thus, the kill probability cannot be stated to be 85%, it can only be stated *with some level of confidence* that the kill probability is 85% or greater, based on the number of tests in the test series and the success rate. For example, if the United States conducts 20 intercept tests and 17 of these are successful, it would have 95% confidence that the single-shot kill probability is 66% or greater, against the type of target it was testing against and under the conditions of its testing. Under the assumption that the failure modes of the interceptors are independent, a single-shot kill probability of 66% would then give the United States 95% confidence that using four interceptors would result in a system effectiveness of 80%, or a 62% confidence that the system effectiveness was 95%. This test series would *not* give 95% confidence that the system effectiveness was 95%.

To obtain high (95%) confidence that the single-shot kill probability was greater than 66%, the tests would have to have a success rate higher than 85%. For a series of 20 tests, all 20 would have to be successful to provide 95% confidence that the kill probability was 85% or greater. On the other hand, if there were three failures in a test series, a total of 50 tests (with the other 47 successful) would need to be conducted to provide 95% confidence that the single-shot kill probability was 85% or greater.

Independence of Failure Modes. Firing more than one interceptor at a target only increases the probability of interception as described above if the kill probabilities for each interceptor are independent. If instead, the failure of one interceptor implies that the others are also likely to fail, the 4-on-1 kill probability can be as low as the single-shot kill probability. In fact, if countermeasures cause one interceptor to fail, they will likely cause other interceptors to fail as well. Thus, the assumption of independent failure modes is probably not warranted for the planned NMD system, which relies on only one type of interceptor (that is, the system is a single-layer system).

¹⁰ Michael Dornheim, “Missile Defense Design Juggles Complex Factors,” *Aviation Week and Space Technology*, 24 February 1997, p. 54. The complete quote is: “Designers expect roughly an 85% probability of kill from a single shot, so multiple shots are used for a tighter shield. Kill assessment is made after the first shot and a second interceptor is fired if necessary, in a ‘shoot-look-shoot’ scheme. To obtain a 95% confidence that a 95% kill probability will be achieved, national missile defense plans call for a ‘4 on 1’ scheme—fire two interceptors at the target, look, then fire another two. This supports fielding 20 interceptors to tackle the minimum threat of five warheads.”

¹¹ Kill assessment may in practice be difficult, so that the NMD system will not know with certainty whether the first round of interceptors has been successful. The kill vehicle might hit a piece of the third stage, for example. However, an analysis of this important topic is beyond the scope of this study.

¹² Dornheim, “Missile Defense Design Juggles Complex Factors,” p. 54.

¹³ A similar analysis would apply if the confidence and effectiveness levels specified in the operational requirements document are other than 95%.

¹⁴ As discussed above, these tests must use the production-quality interceptors that are intended to be deployed. It would not include tests done with prototypes during the development phase.

Testing and Countermeasures

As emphasized elsewhere in this report, missile defense programs will succeed or fail based on their ability to deal with countermeasures. Since operational testing must be conducted under *realistic* battlefield conditions, for ballistic missile defenses this requires that truly representative countermeasures be incorporated into the tests. However, many problems arise in properly integrating countermeasures into a missile defense testing program:

- The countermeasures threat is hard to define. A nation that is developing countermeasures to defeat a US missile defense system may take great care that the details of its efforts are not exposed to US intelligence-gathering efforts or may reveal deliberately misleading information. Emerging missile states may make few missile tests of any kind. And since these countries may not be in a position to evaluate the performance of their own countermeasures through flight testing (because they do not have the large radars and other sensors required to observe the behavior of the countermeasures in tests), they may simply not flight test them. Moreover, an emerging missile state could develop and gain confidence in the performance of some countermeasures through ground tests or tests from aircraft, which would be difficult for the United States to monitor.

As a result, there may be no concrete evidence of countermeasure development and no information available about the types of countermeasures under development by the countries the missile defense system is intended to defend against. This may make it difficult to achieve consensus about what types of countermeasures should be included in tests. But it is important to recognize that the absence of evidence about countermeasures is not evidence of the absence of countermeasures.

A related difficulty is that the defense should also take into account the ability of an emerging missile state to develop countermeasures concurrently with the deployment of an NMD system, and the potential evolution of countermeasures during the lifetime of the defense system as the technological capabilities of emerging missile states increase.

- Even if a “red team” is established to develop

countermeasures, its effect may be impeded by a lack of independence, funding, or other resources, and by not being successfully integrated into the overall testing program. Thus, realistic countermeasure tests that are proposed may never be incorporated into the testing program.

- In the eyes of program managers and senior officials, the success of the testing program is measured by hitting and destroying mock warheads, not by accurately modeling the real world threat. A successful countermeasure may be seen as a threat to the success of the program. This situation creates a conflict of interest that can cripple any serious attempt to incorporate realistic countermeasures into the testing program.

Such problems are widely recognized,¹⁵ and some efforts have been made to avoid them. Following a 1992 Defense Science Board recommendation, BMDO set up a countermeasures effort oriented to the theater missile threat. This effort, called the Countermeasures Hands-On Program (CHOP), is run out of the Phillips Air Force Research Laboratory near Albuquerque. Although it was initially intended to explore only potential countermeasures to theater missile defenses, as the program has progressed, some missions have focused on or have had some application to national missile defenses.¹⁶ In fact, according to the 1996 Defense Science Board report, the program identified submunitions as a serious threat to US theater missile defenses.¹⁷ As noted in Chapter 7, submunitions would be a serious threat to NMD as well.

CHOP’s main task is to build countermeasures, not to theorize about them. The program involves young scientists, engineers, and military officers not specifically trained in missile defense or countermeasures. The team is given access to information and technology in the same way an emerging missile state might get most of its information: through the open literature and

¹⁵ For example, the Defense Science Board in 1992 and in 1996 has discussed difficulties with missile defense countermeasures programs. The 1996 *Report of the Defense Science Board/Defense Policy Board Task Force on Theater Missile Defense* (January 1996) is available at www.fas.org/spp/starwars/offdocs/tmddsb.htm.

¹⁶ Michael Sirak, “BMDO: ‘CHOP’ Shop Helps Create Robust Missile Defenses,” *Inside Missile Defense*, 21 April 1999, p. 1.

¹⁷ *Report of the Defense Science Board*, p. 16.

through commercial off-the-shelf products. However, the CHOP team is prohibited from seeking the advice of outside engineers, whereas an emerging missile state that could deploy a long-range missile would have access to experienced engineers.

The CHOP team assesses how difficult it is to build and deploy a specific countermeasure by developing, building, and testing countermeasure prototypes that represent what a nation with similar resources could do. CHOP missions normally run about nine to twelve months. The watchword of the CHOP missions is simplicity, which helps CHOP programs go from concept to flight testing in months rather than years. CHOP participants usually stay on for only one mission.

It should not, of course, be assumed that the US CHOP program is representative of any particular nation's countermeasure program. In fact, the countermeasures efforts of other countries could well be larger and better funded, and would likely have more experienced personnel who worked on these efforts for long periods of time, rather than for months.

It is clear that the CHOP effort could make a valuable contribution to both theater and national missile defense programs. Nonetheless, the Defense Science Board concluded in 1996 that the theater missile defense red team efforts were not well enough integrated into the full program, and that their output was not used in overall program guidance. Moreover, it appears that since the 1996 Defense Science Board report, CHOP has become a lower priority program with diminished funding. In FY-99 its funding was about \$4.5 million, roughly 20 percent of BMDO's funding for threats and countermeasures activities. CHOP's funding is planned to decrease to about \$3.3 million in FY-00 and \$3.8 million in FY-01.¹⁸

There are also fundamental problems with the CHOP program: because its funding, staff, and direction are under the control of BMDO, the program is not independent. Moreover, the program staff serve for relatively short periods; as a result, the program does not develop a permanent in-house expertise on countermeasures.

However, programs such as CHOP should play a central role in the process of threat validation, in which the United States makes its best guess as to the characteristics of the ballistic missiles and countermeasures that its defense system will face. The threat validation process usually depends heavily on the assessment of

¹⁸ Michael Sirak, "BMDO: 'CHOP' Shop Helps Create Robust Missile Defenses," *Inside Missile Defense*, 21 April 1999, p. 1.

intelligence agencies, but since intelligence may be limited or unavailable, red team efforts such as CHOP provide a needed reality check on the potential countermeasure programs of other countries. Red team efforts may also be the best way to take into account the ability of an emerging missile state to develop countermeasures concurrently with the deployment of an NMD system, and the potential evolution of countermeasures during the lifetime of the defense system as the technological capabilities of emerging missile states increase.

CHOP is, in fact, an example of a new intelligence function, wryly called TRYINT because it involves *trying* to build weapons or countermeasures.¹⁹ Since the conventional intelligence modalities of image intelligence (IMINT), signature intelligence (SIGINT), measurement and signal intelligence (MASINT), and human intelligence (HUMINT) will likely fail to illuminate the dark corners of another country's countermeasures program, the United States must instead try to emulate these countermeasures programs to determine what countermeasures emerging missile states could build with the technology and expertise available to them.

The Planned Testing Program for the NMD System

The operational requirement discussed above—that the United States be 95% confident that the planned NMD system will be 95% effective against a limited attack—may be a desirable objective for a system intended to defend against nuclear or biological weapons. However, is it reasonable to expect that this objective can be met?

Even aside from the countermeasure problem, an effectiveness of 95% is rarely achieved by a military weapons system, even after years of use. Moreover, this confidence requirement is reported to far exceed that for other major defense acquisition programs.²⁰ An additional problem is that an NMD system must work the *first* time it is actually used. If an ICBM attack on

¹⁹ TRYINT has been emphasized by William R. Graham, who served President Reagan as science adviser and head of NASA. US Senate Committee on Governmental Affairs, "The Proliferation Primer: A Majority Report of the Subcommittee on International Security, Proliferation, and Federal Services," January 1998, p. 63.

²⁰ Michael Sirak "DOD, Industry: NMD Countermeasures Getting Attention," *Inside Missile Defense*, 19 May 1999, p. 1.

the United States occurs, there will be no opportunity to learn on the job.

Determining the system effectiveness with a confidence level of 95% will, as discussed above, require extensive testing. Because the real-world operating environment could vary greatly depending on the types and combinations of countermeasures the attacker uses, achieving a 95% confidence level in the system effectiveness would require hundreds of tests conducted under different scenarios, costing billions of additional dollars. (As noted above, the Pentagon reported that the October 1999 NMD intercept test cost \$100 million.)

However, if the tests do not adequately approximate the conditions under which the system would operate, then even a large number of successful tests will provide little meaningful information about the system's operational effectiveness. Worse, such tests could encourage a false sense of confidence in the system.

How does the Pentagon's planned testing program²¹ measure up? Table 10-1 gives the schedule of the intercept tests currently planned through 2005, when the United States might complete the initial deployment of the system.

First, are there enough tests to determine the system effectiveness with a high level of confidence? Three intercept tests are scheduled prior to the Deployment Readiness Review, when the Pentagon will assess the technological readiness of the system for deployment. A total of 19 intercept tests are scheduled through 2005. However, only the last three of these tests are operational tests. The first 16 flight tests are part of the engineering and manufacturing development phase and cannot be used to assess the effectiveness of the deployed system. (The main objective of the first four flight tests is to demonstrate the capability to perform hit-to-kill intercepts. The next seven flight tests are intended to develop and demonstrate full system integration, and the following five will complete the development phase.²²)

Nothing about the system effectiveness will be known before the Deployment Readiness Review, and very little will be known by the initial deployment date. Additional operational tests will presumably be scheduled to take place after initial deployment, but many additional tests will be required for the United States

to know with any confidence what the system effectiveness might be.

Second, against what type of threat (and countermeasures) will the system be tested? Even a large number of operational tests will reveal nothing about the operational effectiveness of the NMD system if it is not tested against the type of threats that will be found in the real world.

None of the 19 intercept tests planned through FY 2005 will use credible countermeasures. According to the DOT&E FY 1999 Annual Report, these tests will only assess the capability-1 (C-1) phase of the system (see Chapter 3).²³

The three intercept tests that will have taken place before the Deployment Readiness Review will not even begin to address the question of how well the system would work in the real world. As we discussed above, these tests will be limited to demonstrating the basic functioning of the system in a relatively benign test environment. The balloon decoy used in the first two NMD intercept tests in October 1999 and January 2000, and those to be used in the next four intercept tests will help the Pentagon assess whether the kill vehicle can perform the basic task of using its infrared sensor to detect and distinguish objects of different temperatures. But the NMD system faces a vastly more difficult task: discriminating a real warhead from false decoys in a situation in which anti-simulation is used to disguise the warhead and the defense does not know in advance what the warhead will look like. The planned tests will not even attempt to demonstrate this capability.

Some of the additional 16 intercept tests that are planned before the target deployment date of 2005 will reportedly use additional decoy targets.²⁴ However, the DOT&E FY 1999 Annual Report indicates these tests are not intended to assess the operational effectiveness of the system against real-world countermeasures. The DOT&E report further states that "The NMD ... program is building a target suite that ... may not be representative of threat penetration aids.... Test targets of the current program do not represent the complete 'design-to' threat space and are not representative of the full sensor requirements spectrum (e.g., discrimination requirements). Much of this limitation is attributable, however, to the lack of information surrounding the real threat." The report further notes that "NMD

²¹ The BMDO test program is described in Fact Sheet JN-99-07. The BMDO Fact Sheets and other information can be found at www.acq.osd.mil/bmdo/bmdolink/.

²² Michael C. Sirak, "BMDO Plans Two NMD Flight Tests with Special Threat-Like Targets," *Inside Missile Defense*, 1 December 1999, p. 10.

²³ "DOT&E FY99 Annual Report," submitted to Congress February 2000, available online at www.dote.osd.mil/pubs.html. See table on page VI-8.

²⁴ Robert Wall, "Intercept Boosts NMD Design," *Aviation Week and Space Technology*, 11 October 1999, p. 34.

Table 10-1. Schedule of the NMD Intercept Tests Currently Planned.

All tests through FY2005 will be of only the Capability 1 (C-1) system.^a

IFT= Integrated Flight Test

Date	Test or Decision
June 1997	IFT-1, a "fly-by" test to evaluate the ability of the kill vehicle sensors to detect a target warhead and a target cloud of decoys as it flew past them.
January 1998	IFT-2, a second "fly-by" test of the kill vehicle as described above.
2 October 1999	First intercept test (IFT-3); tested only the kill vehicle. Kill vehicle hit the target but anomalies in the test have raised questions about the relevance of the test.
18 January 2000	Second NMD intercept test (IFT-4); kill vehicle failed to intercept the target, reportedly due to a failure in its infrared sensors.
June 2000	Third intercept test (IFT-5); first planned integrated system test (IST). All NMD system elements will be tested, although as in previous tests, a surrogate interceptor booster will be used.
July 2000	Deployment Readiness Review (DRR) According to then-director of the Ballistic Missile Defense Organization Lt. Gen. Lyles, "[The DRR] will not constitute the actual decision to deploy the NMD system. It will assess whether or not the technical progress has been made which would allow more senior decision-makers to decide whether or not we should commit to deployment. At this time, the administration will also assess the threat, the affordability of the system, and the potential impact on treaty and strategic arms reduction negotiations." ^b
Fall 2000	Possible Presidential Deployment Decision The deployment decision will involve the NMD Joint Program Office in the Pentagon, the Defense Acquisition Board, the Secretary of Defense, the National Security Council (which will consult with the State Department), and the president, in consultation with Congress.
Fall 2000 (?)	NMD intercept test 4 (IFT-6).
FY2001	NMD intercept tests 5, 6, 7. Intercept test 5 (IFT-7) would be the first to use the prototype interceptor booster. First Defense Acquisition Board review of NMD will consider the initiation of production authorization for sensors and battle management, command, control and communications (BMC3). ^{ab}
FY2002	NMD intercept tests 8, 9, 10.
FY2003	NMD intercept tests 11, 12, 13. Intercept test 12 (IFT-14), planned for first quarter FY2003 (early 2003), would be the first test of the "production-quality" ground-based intercept—both the kill vehicle and the booster.
FY2003	Second Defense Acquisition Board review of NMD will consider granting approval to "build and deploy the weapon system—the ground based interceptor." At this point BMDO "would seek authorization to procure 61 GBI missiles—this would include deployment interceptors, spares, and test rounds." ^b
FY2004	NMD intercept tests 14, 15, 16.
FY2005	NMD intercept tests 17, 18, 19. These are Initial Operational Test and Evaluation (IOT&E) flights.
FY2005/2006	NMD initial operating capability (IOC).
2006	First launch of SBIRS Low. Final deployment of 24 low-earth orbit satellites in FY2010.
Late FY2007	Deployment expanded to 100 interceptors.

Compiled from Inside Missile Defense.

^a "DOT&E FY99 Annual Report," submitted to Congress February 2000, available online at www.dote.osd.mil/pubs.html. See table on page VI-8.

^b Statement of Lester L. Lyles, Director of BMDO, to the Subcommittee on Strategic Forces, Committee on Armed Services, US Senate, 24 Feb. 1999 (available online on the BMDO website at www.acq.osd.mil/bmdo/bmdolink/html/lyle24feb.html)

system performance against multiple targets is not currently planned for demonstration in the flight testing program.”

Given the extremely demanding operational environment the NMD system will face, and given the need for it to work the first time it is actually used, it is implausible that the system will even approach the high levels of effectiveness claimed for it. Moreover, the inadequate testing program planned means that the United States will not have high confidence in what the system effectiveness is. In fact, US planners will have no real basis for knowing what its effectiveness will be by the time it is deployed.

An NMD Testing Program to Assess Operational Effectiveness

What can be done to improve the NMD testing program so that it can assess the operational effectiveness of the planned NMD program against the threats it is intended to address? At a minimum, the NMD testing program must

1. Ask the right question: Accurately define the baseline threat

The operational effectiveness of an NMD system will depend sensitively on the nature of the ballistic missile threat it confronts. It is therefore essential that the Pentagon accurately define the baseline threat that the NMD system must be able to address. And this baseline should be used to assess the operational effectiveness of the defense. A defense that is not designed for the real world cannot be expected to work against the real-world threat.

Because the testing program will be designed according to the threat identified in the STAR document, it is imperative that this document reflect the real baseline threat. As discussed above, the planned testing program and other evidence strongly suggest that the existing STAR document does not reflect the real world threat from emerging missile states. In accordance with its own national intelligence estimate, the US government must assume that any ballistic missiles used by emerging missile states will include countermeasures of the type discussed in Chapters 7–9.²⁵ Because it is so important, the STAR document should be reviewed by an independent panel of qualified experts.

2. Make it possible to get a valid answer to the question: Provide for the best in countermeasure testing

Assuming the Operational Requirements Document accurately reflects the threat from emerging missile states by requiring that the NMD system work against countermeasures such as those we discuss in Chapters 7–9, the issue still remains of what countermeasures to test the system against. To assess its operational effectiveness, the NMD system must be tested against a wide variety of countermeasures that approximate as closely as possible those that would be available to emerging missile states. Since only limited intelligence information, if any, will be available about the countermeasures programs of emerging missile states, the United States must rely on red team efforts and other “TRYINT” programs to determine what countermeasures the NMD system should be tested against.

The defense system must be tested against the most effective countermeasures that the emerging missile states could field. It is clearly important that the countermeasures that are developed and tested are not “dumbed down” to make the job of the defense easier. To insure that this does not happen, the countermeasures program must be independent and adequately funded, and its output fully incorporated in tests and evaluation.

The red team effort currently carried out by CHOP and others is potentially valuable, but is completely under the control of the Ballistic Missile Defense Organization, which has a conflict of interest in overseeing an effort that could demonstrate its planned NMD system could be defeated. To insure independence and remove potential conflicts of interest, the red team activities would need to be conducted under the auspices of a competent technical agency other than BMDO and the associated military services. For example, the Defense Advanced Research Projects Agency (DARPA) is both technically competent and independent of BMDO and the services, since DARPA reports to the Director for Defense Research and Engineering in the office of the Under Secretary of Defense for Acquisition and Technology.²⁶

Moreover, to help compensate for the shortage of intelligence information on the countermeasure programs of other states, it is important that there be close

²⁵ National Intelligence Council, “National Intelligence Estimate (NIE): Foreign Missile Development and the Ballistic Missile Threat to the United States Through 2015,” unclassified summary, September 1999, p. 16.

²⁶ For more information on DARPA, see its website at www.arpa.mil. According to this website, DARPA is “designed to be an anathema to the conventional military R&D structure and, in fact, to be a deliberate counterpoint to traditional thinking and approaches.”

coordination between the US red team countermeasure programs and the US intelligence community, in both tasking and evaluating intelligence collection.

3. Answer the question well: Conduct enough tests

As the two panels headed by General Welch noted, to avoid a “rush to failure,” testing must be outcome-driven and not schedule-driven.²⁷ There must be an opportunity to assimilate the results of one test before rushing headlong into another. Program managers must carefully distinguish testing done to learn and testing done to verify.

Thus, it is important that the NMD program be insulated from congressional and administration pressures for unrealistic testing and deployment schedules.

In addition, while extensive ground tests and simulation are essential, the only way to gain confidence in the system performance is to conduct a relatively large number of operational flight tests. The number of tests required to gain a given level of confidence in a given system effectiveness cannot be determined in advance because that will depend on the cumulative test record and on when in a test series any failures occur.

For example, if the goal is to provide 95% confidence that the single-shot kill probability was 85% or greater, then a minimum of 18 tests would be required and all 18 would have to be successful. If there were 3 failures in the first 20 tests, then a total of 50 tests (with the other 47 successful) would need to be conducted to provide 95% confidence that the single-shot kill probability was 85% or greater.

Taking into account that a different test series will be needed to assess the system effectiveness against each different type of countermeasure, it is not unreasonable to assume that the United States would need to conduct a total of *at least* 100 intercept tests to determine the system effectiveness was 95% with a 95% level of confidence. If the cost of each operational test were half that of the first intercept test—which was \$100 million—then the total cost of these 100 tests would be \$5 billion.²⁸ This is not too much to pay to gain some understanding of the operational effectiveness of the NMD system.

²⁷ Report of the Panel on Reducing Risk in BMD Flight Test Programs, Gen. L. Welch (ret) et al., February 1998 and November 1999.

²⁸ Tests against multiple ballistic missiles would be more expensive.

4. Make sure the answer is correct: Provide for objective, independent test assessment

NMD program managers will have a strong bias to find more success in a test than may actually exist since there are strong incentives to believe in a program in which one has invested a lot of time and energy. For example, the Navy termed the fourth LEAP intercept test “a clear success” with 42 of 43 objectives met, even though it failed to hit its target (see Appendix J). Moreover, political and financial support for the project will depend on the perception that the project is making progress. For military contractors, future contracts may be tied to a successful testing program. The only way to insure that such biases and conflicts of interest do not unduly affect the assessment of the operational effectiveness of the NMD system is to have an independent body that can provide objective assessments of the NMD testing program and the countermeasures included in it.

If an independent red team is created, there will also be sources of friction and conflicting motives between the red team and BMDO. There are likely to be disagreements over what countermeasures to test, and BMDO might be tempted to declare victory over countermeasures based on flight tests against less than the best countermeasures potentially available to an emerging missile state. In this situation it is especially important that there be an independent body that can provide objective assessments of the testing program. This body would essentially serve as a referee of the contest between the red team and BMDO.

The office of the Director, Operational Test and Evaluation (DOT&E) serves many of these purposes. As discussed above, DOT&E must approve the plans for operational test and evaluation and write a report assessing whether the testing program confirms that the system is suitable for military use before the program is authorized to proceed beyond a low rate of initial production. It is independent of missile defense efforts within the Department of Defense and reports to the Secretary of Defense and to Congress. Indeed, DOT&E’s most recent (1999) report to Congress demonstrates that it is willing to do its job and be critical of the NMD testing program.

Unfortunately, however, missile defense programs have become so politically charged that there are strong political incentives for policymakers to ignore DOT&E’s assessments. For example, in June 1999, the US House of Representatives included a measure in its

version of the defense authorization bill that would have allowed the Secretary of Defense to make the decision to proceed with production of the NMD system, regardless of whether it had completed initial operational test and evaluation. The measure sought to waive the requirement discussed above that DOT&E must certify that a major defense acquisition program like NMD has successfully completed initial operational test and evaluation before it can go beyond low-rate initial production.²⁹ Although the measure was not part of the final defense authorization conference bill, it demonstrates the limits of DOT&E's effectiveness.

In the THAAD program, as well, the Pentagon

chose to ignore a recommendation from DOT&E that the program should not move to the next stage of its development before five additional flight tests were completed. After reviewing warnings from DOT&E that THAAD intercept tests were not challenging enough and that more tests under realistic conditions were needed before committing to the missile's design, the BMDO decided to reject this advice, saying that "it's not logistically possible."³⁰

Thus, in addition to the assessments provided by DOT&E, we recommend that a standing high-level independent review panel be established to review the NMD testing program and its results.

²⁹ Michael C. Sirak, "Measure to Ease NMD Production Requirements Defeated in Conference," *Inside Missile Defense*, 25 August 1999, pp. 1, 18–19.

³⁰ Gopal Ratnam, "THAAD to Stay on Schedule Despite Call for More Tests," *Defense News*, 20 December 1999, pp. 3, 50.

Chapter 11

Past US Tests Against “Countermeasures”

The United States has conducted several flight tests of missile defense components—both those for national missile defenses and for theater missile defenses using hit-to-kill interceptors—that have included decoys or other countermeasures. These have sometimes been described as demonstrating that the defense was able to discriminate the decoys from the mock warhead or otherwise defeat the countermeasures. A closer look, however, shows that these tests in no way demonstrate that the defense could address even simple countermeasures. In fact, in these tests, the defense relied on information about the differences between the mock warhead and decoys that would not be available to the defense in the real world.

While the public information about these tests is limited, we discuss below what is known about them. Appendix J gives a summary of information about all the exoatmospheric hit-to-kill intercept tests that have taken place through January 2000.

The Use of “Decoys” in ERIS Tests

On 28 January 1991, the first intercept test of the Exoatmospheric Reentry Vehicle Interceptor System (ERIS), which was intended to intercept long-range missiles, reportedly hit and destroyed a mock reentry vehicle target that was accompanied by decoys. The kill vehicle did not discriminate the warhead from the decoys, however. Instead, two balloon “decoys,” each with a diameter of 2.2 meters, were tethered to the dummy warhead about 180 meters apart, and the kill vehicle was told in advance which one of the three objects it should home in on, based on their relative positions.¹ The kill vehicle also collected one-color

infrared data on the dummy warhead and the decoys that would be used to tell them apart in the next test.

The second ERIS intercept attempt, on 6 March 1992, included a dummy warhead and a single balloon decoy, which were separated by about 20 meters. The kill vehicle reportedly detected the two objects and then “discriminated” between them using a one-color infrared sensor and the warhead and decoy infrared signatures collected in the first test. However, because the balloon decoy was further away from the warhead than expected, ERIS failed to hit the target, missing by several meters.²

There is no doubt, of course, that infrared sensors can tell the difference between objects based on their thermal signatures when these characteristics are known in advance, as was the case here. The difficulty in a real situation would be in knowing whether the real warhead is the hotter or cooler object; without knowing this, simply distinguishing hot objects from colder ones does not help.

MSX Experiment

The Midcourse Space Experiment (MSX) satellite, launched in April 1996, is designed to collect infrared and visible data for use in designing future space-based missile tracking sensors. In the MSX Dedicated Target Mission (MDT II on 31 August 1996), the premier target mission for the MSX program, a missile deployed a set of 26 objects including balloons and light rep-

ogy, 4 February 1991, p. 22; “ERIS Flight 2 Results,” briefing slides, Lockheed Missiles and Space Company, 1992.

² “SDI Experimental Interceptor Misses Dummy Warhead in Final Flight Test,” *Aviation Week and Space Technology*, 23 March 1992, p. 20; Vincent Kiernan and Debra Polsky, “SDI Interceptor Fails to Hit Target,” *Defense News*, 23 March 1992, p. 8; “ERIS Flight 2 Results,” briefing slides, Lockheed Missiles and Space Company, 1992.

¹ James Asker, “Army ERIS Interceptor Destroys Dummy Warhead in SDI Test,” *Aviation Week and Space Technol-*

Discrimination

One of the key issues in the countermeasures debate is whether the NMD system would be able to discriminate real warheads from decoys and other objects. The term “discrimination,” however, is typically used in several ways and its meaning is therefore sometimes ambiguous. Because this issue is so central, we discuss it briefly here.

As we discuss in this chapter, there have been several tests of missile defense systems for which the Pentagon stated that the system was able to discriminate the mock warhead from other objects. However, in these tests, the defense system knew what it was looking for—it knew what the various objects would look like to its sensors. This type of “discrimination” is similar to telling someone that the warhead would be red and the decoys blue, then showing them a red and a blue object and telling them to point to the warhead. Demonstrating that a missile defense system can do this level of discrimination is a necessary step in the

development process, but should not be confused with the full job that it would have to do to be effective in a real attack.

The situation facing a defense system in the real world would be quite different. As we discussed in earlier chapters, the attacker could readily take steps to disguise the warhead so that it would not look like what the defense would expect it to. The attacker could both prevent the defense sensors from seeing target characteristics the defense would expect to see, and add other characteristics the defense would not expect to see. In this case the defense sensors may be able to identify differences between the objects it sees, but would have no idea which of the objects was the warhead. In other words, the defense could not know in advance that the warhead would be red.

Thus, the relevant meaning of “discrimination” is not only detecting differences between objects, but also determining which object is or contains the warhead.

lica decoys along with a mock warhead for observation by the MSX satellite. In Congressional testimony, then-BMDO-director Lt. General Lester Lyles showed an MSX infrared image of these objects being deployed at a range of 1,000–2,000 kilometers from the MSX satellite and stated that, “This kind of discrimination data is absolutely crucial and essential to our sensors to be able to perform the kind of mission we have to have them do for our NMD program...”³ It is likely that this image is similar to the long-range view seen in the kill vehicle sensor fly-by tests (see below), although the target set was somewhat different.

However, this test did not establish a discrimination capability, only that infrared sensors can distinguish between targets with different infrared signatures and identify a given target based on characteristics that are known in advance. As General Lyles went on to say, “The actual RV [reentry vehicle] in the left chart that you see is the brightest target...” In the real world, there would be no way for the United States to know in advance that the reentry vehicle would be the brightest object.

Sensor Fly-by Tests for NMD

Two sensor fly-by tests have been conducted as part of the current NMD testing program. In those tests, the infrared sensors of the kill vehicle flew past a set of objects in space and observed them. The target set reportedly included nine objects, including a “medium” RV, a large balloon, medium balloons, canisterized small balloons, small canisterized light replica decoys, and medium rigid light replica decoys.⁴ A BMDO official stated that this target set “replicates a number of systems that we could face,”⁵ and Maj. Gen. William Nance, NMD program manager, said in each case the target suite was “a more complex target array than we would expect from a rogue state.”⁶ An infrared sensor designed by Boeing was tested on 23 June 1997, in the first Integrated Flight Test (IFT), and one designed by Raytheon was tested on 15 January 1998, in IFT-2. In both cases, the sensors were reported to have imaged the targets and the clear impression given by press reports was that the sensor was able to detect the mock reentry vehicle among the decoys. However, a recent report contradicts the claim that the kill vehicle

³ Department of Defense Authorization for Appropriations for Fiscal Year 1998 and Future Years Defense Program, Committee on Armed Services, US Senate, part 7, 27 February 1997, p. 10. The infrared image shown by General Lyles can be seen on the MSX homepage at <http://scies.plh.af.mil/Latest/dark.htm>. Reflected visible light images of the same scene are at http://scies.plh.af.mil/Latest/mdt_ii_boost.htm.

⁴ Joseph Anselmo, “Pentagon to Spend Big on NMD Testing,” *Aviation Week and Space Technology*, 22 September 1997, p. 88.

⁵ Anselmo, “Pentagon to Spend Big on NMD Testing,” p. 88.

⁶ Michael C. Sirak, “In NMD Test, Beacon Will Help Position EKV Until Booster Release,” *Inside Missile Defense*, 5 May 1999, p. 19.

successfully discriminated the mock warhead in the 1997 test. Instead, the kill vehicle apparently selected a decoy, rather than the warhead, as the target.⁷

In these tests the infrared sensor knew what signatures it was looking for and there was no attempt to disguise the warhead through anti-simulation, that is, by changing its physical characteristics so that it no longer looked like a warhead. Had anti-simulation been used, one would expect that the sensor would still have been able to image all of the objects, but would not have seen characteristics of the warhead that it could have used to identify it. The reported 1997 test failure indicates that even with advance knowledge of how the warhead would appear and no attempt to disguise it by anti-simulation, identifying the proper target can be very difficult.

Tests of Ground-Based Radar at Kwajalein

Several tests for the NMD program have been done as part of the Air Force's routine test flights of Minuteman III ballistic missiles. For example, on 20 August 1999, a reentry vehicle and several countermeasures (two rigid lightweight replicas (RLRs) and a chaff package) were launched on a Minuteman III missile toward Kwajalein to give the ground-based radar there practice in tracking these objects. (This test was named Glory Trip 170 GM-1.) The reentry vehicles and replicas were each instrumented to collect motion and attitude data to be used in an analysis of the performance of the objects and the radar. Only the reentry vehicle survived reentry.⁸

As above, there was apparently no attempt to disguise the reentry vehicle. While this test provided information on the signatures of these particular targets, this data could not be adequate for discrimination if an attacker used anti-simulation to disguise the characteristics of the targets in unknown ways.

First NMD Intercept Test

The first intercept test (IFT-3), conducted on 2 October 1999, tested only the exoatmospheric kill vehicle (EKV); none of the other system components were integrated into the test. Instead, to simulate the information that would normally be provided by the radars, a GPS (global positioning system) transmitter on the

target provided the target location to the interceptor booster to allow it to dispense the EKV in the correct place.

The target suite for the first NMD intercept test (IFT-3, on 2 October 1999) consisted of a reentry vehicle less than two meters long and less than one meter in base diameter, and one balloon decoy with a diameter of 2.2 meters made of radar-reflecting material (see Figure 11-1). The bus used to release the reentry vehicle was also reportedly in the field of view of the kill vehicle's sensor and also had to be discriminated from the reentry vehicle.⁹ After it was dispensed, the kill vehicle reportedly discriminated the reentry vehicle from the balloon decoy and the bus without outside assistance, and then successfully intercepted the reentry vehicle.

In discussing the first intercept test, Brig. General William Nance, the NMD JPO Program Manager, "characterized the target suite as 'more than representative' of the decoys and countermeasures that a rogue state might employ."¹⁰ John Peller, vice-president and NMD program manager at Boeing, stated that "the target suite was equal to, if not more challenging than, the current projected rogue threat."¹¹

However, these claims are not valid since the test did not use anti-simulation or attempt to disguise the signature of the warhead in any way. The test was not one of discrimination since it relied on the defense knowing in advance that the reentry vehicle would be the object with the smallest infrared signal. Indeed, in a briefing the day before the test, a Pentagon official stated that the difference in thermal signature of the reentry vehicle and balloon would be "pretty significant."¹² Brig. General William Nance later described the reentry vehicle as "the least visible in the IR [infrared] spectrum of all the elements in the target array, and the smallest of all the objects in the target array."¹³

Moreover, the Pentagon admitted in January 2000 that there had been a series of anomalies in the test, which sheds additional light on the issue of "discrimination." The sensors on the kill vehicle were

⁷ William J. Broad, "Ex-Employee Says Contractor Faked Results Of Missile Tests," *New York Times*, 7 March 2000, p. A1.

⁸ "USAF Launch Gives NMD Radar Operators Practice For NMD Flight Test," *Inside Missile Defense*, 25 August 1999, p. 14.

⁹ "NMD Kill Vehicle Performed 'Very Well' in Flight Test, Officials Say," *Inside Missile Defense*, 20 October 1999, pp. 1, 19-21.

¹⁰ "BMDO: Only Three NMD Tests 'Likely' Before Next Year's NMD Review," *Inside Missile Defense*, 25 August 1999, p. 13.

¹¹ "NMD Kill Vehicle Performed 'Very Well'," p. 20.

¹² Department of Defense Press Briefing on the NMD Intercept Test, 1 October 1999.

¹³ "NMD Kill Vehicle Performed 'Very Well'," p. 19.

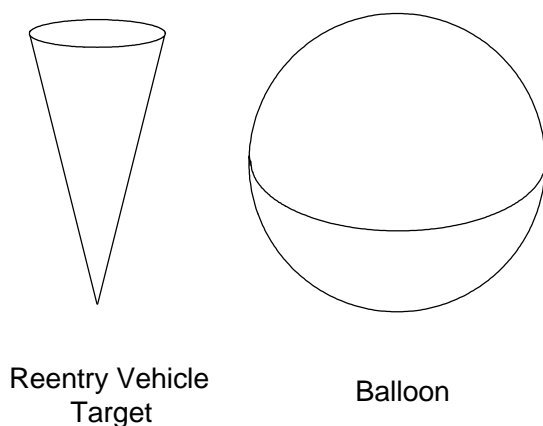

Figure 11-1. The target suite for the first two NMD intercept tests.

This figure shows a reentry vehicle that is 2 meters long and 1 meter in diameter and a spherical balloon 2.2 meters in diameter. The bus used to release the reentry vehicle was reportedly also in the vicinity of the targets during these tests.

initially unable to find the mock warhead. The sensors did see the balloon, which the kill vehicle apparently immediately recognized as the balloon rather than the warhead.¹⁴

Thus, the “discrimination” was not even based on relative measurements of the balloon and kill vehicle, but instead relied on the defense knowing in advance the characteristics of the targets. In a real attack, the defense would not know in any detail what the warhead would look like, especially if the attacker took simple steps to disguise it, as one has to expect it would do. Instead, the test was a test of how sensitive the sensors are and of the algorithms used by the NMD system and of the kill vehicle’s ability to home on and hit a target. In the October 1 briefing, the Pentagon briefer said that “What we’re testing are the algorithms... When you have multiple objects, regardless of their signature, you want to make sure you pick the right one.” While it is certainly necessary to test the algorithms, it is not the same as testing the discrimination ability of the kill vehicle.

Interestingly, the ground-based radar at Kwajalein, which is a prototype of the X-band radar planned for the NMD system, exhibited a glitch during the test. The radar was not included in the test (i.e., it was not controlling the engagement or communicating with the interceptor), but it was observing the test and tracking the target objects. After initially correctly identifying the reentry vehicle, it switched and identified one of the decoys as the reentry vehicle before again switching back to correctly identify the reentry vehicle.¹⁵

Second NMD Intercept Test

The second intercept test (IFT-4) conducted on 18 January 2000, included more components of the system, but used the same target suite as the first test (see Figure 11-1). The intercept was not successful, reportedly due to a failure of the kill vehicle’s infrared sensors.

An ERINT Test Against “Submunitions”

One occasionally sees reports that the ERINT interceptor (which evolved into the interceptor for the Patriot PAC-3 theater missile defense system) was successfully tested against submunitions carrying a simulated chemical agent. Like the NMD interceptor, the PAC-3 interceptor is a hit-to-kill weapon, but unlike the NMD system, PAC-3 operates within the atmosphere and against much shorter-range missiles. These reports refer to an intercept test conducted on 30 November 1993. Reports state the target missile carried 38 canisters filled with water intended to simulate chemical weapons submunitions, and that ERINT successfully intercepted and destroyed all of the canisters.¹⁶

However, it is clear from the description of this test that the submunitions were not dispersed early in flight, as would normally be done to counter a defense. Instead the canisters were all clustered together in a single package, which makes no sense from the point of view of an attacker facing a missile defense. So this test in no way demonstrated that a defense can successfully intercept submunitions.

¹⁴James Glanz, “Flaws Found in Missile Test that U.S. Saw as a Success,” *New York Times*, 14 January 2000, p. A1; Department of Defense Press Briefing, 14 January 2000.

¹⁵Robert Wall, “Intercept Boosts NMD Design,” *Aviation Week and Space Technology*, 11 October 1999, p. 34.

¹⁶David Hughes, “Army Selects ERINT Pending Pentagon Review,” *Aviation Week and Space Technology*, 21 February 1994, p. 93.

Chapter 12

The Security Costs of NMD Deployment

The mission of the proposed US National Missile Defense (NMD) system, as stated in the National Missile Defense Act signed by President Clinton on 23 July 1999, is to defend “the territory of the United States against limited ballistic missile attack (whether accidental, unauthorized, or deliberate).” In this context, “accidental” and “unauthorized” refer primarily to Russia, while “deliberate” refers to China and to other potentially hostile states (e.g., North Korea, Iran, and Iraq) that might acquire a small number of intercontinental ballistic missiles (ICBMs) armed with nuclear or biological warheads.¹

The purpose of an NMD system is to reduce the risk to US citizens of large-scale death and destruction. This is a critical mission, but it can be achieved only if the decision to deploy such a system would not trigger reactions by other states that, on balance, would result in increased risks to the United States. In short, the gains in security must exceed the losses.

Previous chapters have examined the security benefits of the proposed NMD system: its ability to protect the United States against a small number of ballistic missiles armed with nuclear or biological warheads. We have concluded that the proposed system would not provide an effective defense if the attacker employs relatively simple countermeasures, such as submunitions and balloons, which are well within the technical capacity of any country able to build long-range ballistic missiles.

In this chapter, we consider how states are likely to respond to the deployment of the proposed NMD system and how these responses would affect the

security of the United States. Below we examine, in turn, the potential reactions of Russia, China, emerging missile states, and other states.

Russia

Russia’s strategic missile force is the only sector of the former Soviet military complex that retains anything like its Cold War capability. Today, Russia deploys over 1,000 strategic missiles armed with more than 5,000 warheads.² Russia will place a high priority on maintaining this force as its only credible deterrent against the military power of the United States, an eastwardly expanding NATO, and China. Although Russia’s nuclear forces are expected to decline, with or without continued progress in negotiated arms reductions, Russia is expected to be able to maintain a force of 3,000-4,000 warheads through at least the next decade (see Chapter 2).

The planned NMD system, with up to 250 interceptors, obviously would not be able to protect the United States from a Russian attack involving even 1,000 warheads. One might therefore conclude that the system would not threaten the Russian nuclear deterrent. But Russian military planners, like their US counterparts, will consider scenarios in which their retaliatory capacity might be limited by enemy attacks. For example, Russia will consider the possibility of US nuclear attacks against its nuclear forces. Today, only a small fraction of Russia’s nuclear forces are

¹ As discussed in Chapter 2, a Chinese accidental or unauthorized launch is not currently a concern because China deploys its long-range missiles without fuel and with the warheads stored separately.

² “START I Aggregate Numbers of Strategic Offensive Arms, as of 1 July 1999 as compiled from individual data submissions of the Parties,” available online at the State Department website at www.state.gov/www/global/arms/factsheets/wmd/nuclear/start1/startagg.html. Includes 756 ICBMs armed with 3,560 warheads and 440 SLBMs armed with 2,272 warheads.

positioned to survive such an attack—perhaps only tens of missiles carrying fewer than 200 warheads.³ Russia would also be concerned about the possibility of US attacks intended to destroy Russia's ability to command its nuclear forces.

A US surprise attack might seem inconceivable. Any use of nuclear weapons would probably be preceded by an extended crisis and conventional combat, so that Russia would have ample time to alert its nuclear forces and improve their survivability. But Russia is likely to worry that a crisis could lead to rapid and highly effective conventional attacks by superior US or NATO conventional forces against Russian bombers, ports, and submarines at sea. Or it might be reluctant to alert its forces for fear of worsening the crisis or triggering preemptive attacks. Even if it did alert its forces, Russia might be concerned that the United States would exploit gaps in its early-warning system to launch an attack that could destroy much of its strategic forces. In any case, the proposed US NMD system looms much larger when measured against the relatively small Russian force that might survive US attack and be capable of retaliation.

Russia will also consider the possibility of the NMD system being expanded far beyond current proposals. As described in Chapter 3, the proposed system includes numerous ground-based radars and satellite-based infrared sensors, giving the United States the nominal capability to track thousands of Russian warheads with high accuracy. Once this sensor system is deployed it would be relatively easy for the United States to field hundreds of additional interceptors and greatly expand the capacity of the system. This concern is currently addressed by the Anti-Ballistic Missile (ABM) Treaty, which imposes strict limits on the location and capabilities of radars to prevent either country from providing a base for a nationwide defense.⁴

Indeed, Russia may worry that the United States could expand the capacity of its NMD very rapidly by using NMD sensors to increase the range and capability of theater missile defense systems, particularly such as the planned Navy Theater-Wide system. Although

the United States has provided assurances that it will not deploy these systems "in numbers and locations so that these systems could pose a realistic threat" to Russia's strategic nuclear force,⁵ this system is highly mobile and the total number of interceptors planned is very large (more than 600). And as a recent BMDO report on the potential utility of the Navy Theater-Wide system to the NMD mission acknowledges, the NMD system's X-band radars could support the Navy Theater-Wide interceptor in engagements against long-range strategic missiles.⁶ The report concluded that integrating the planned Navy Theater-Wide system into the planned ground-based NMD system would result in a more flexible and robust national missile defense.

Finally, Russia may have concerns about even the nominal purpose of the proposed NMD system. Because the system is intended to protect the United States against accidental and unauthorized attacks, it must be designed to destroy at least a few Russian warheads.⁷ Russia might view this as an attempt to deny its ability to use or threaten to use one or a few missiles against the United States. Although it is difficult to imagine the circumstances under which limited Russian attacks would make sense, we have little doubt that Russian attack plans include such options and that Russian planners would seek to preserve them.

Because of these considerations, it is highly likely that Russia would adjust its nuclear force posture in response to the deployment of the planned NMD system. Even if Russian leaders could be convinced that US intentions were benign and that the proposed NMD system would not threaten Russian security, Russian pride and prestige would be at stake and there would be enormous political pressure to respond militarily.

Russia could respond in several ways. First, Russia could equip its missiles with a variety of counter-

³ Russia reportedly averages one regiment (nine single-warhead missiles) of mobile missiles out of garrison and one or two ballistic-missile submarines (16 to 36 missiles armed with 64 to 264 warheads) on combat patrol at sea. Harold Feiveson, et al., *The Nuclear Turning Point* (Washington, D.C.: Brookings Institution Press, 1999), p. 109.

⁴ Lisbeth Gronlund and George Lewis, "How a Limited National Missile Defense Would Impact the ABM Treaty," *Arms Control Today*, November 1999, pp. 7-13.

⁵ "Agreement on Confidence-Building Measures Related to Systems to Counter Ballistic Missiles Other Than Strategic Ballistic Missiles," 26 September 1997, available online at the State Department website at http://www.state.gov/www/global/arms/factsheets/missdef/abm_cbm.html.

⁶ Ballistic Missile Defense Organization, "Summary of Report to Congress on Utility of Sea-Based Assets to National Missile Defense" 1 June 1999.

⁷ According to US officials, the planned NMD system "would also provide some residual capability against a small accidental or unauthorized launch of strategic ballistic missiles from China or Russia" (Jacques S. Gansler, Under Secretary of Defense for Acquisition And Technology, Testimony before the House Armed Services Subcommittees on Research and Development and Procurement, 25 February 1999).

Russian Statements on NMD

It is difficult to over-estimate the ABM treaty's "tremendous significance as a factor of strategic stability and international security.... Implementation of existing plans for deployment of national anti-missile defense systems would constitute a violation of fundamental obligations under the ABM treaty—not to deploy ABM systems for the defense of national territory—and will lead to actual abolition of the treaty. Such a development would inevitably upset the whole system of international treaties in the disarmament field, it can trigger a new round of a strategic arms race including in outer space, and undermine the existing non-proliferation regime."

—**Vasily Sidorov, Russian Ambassador to UN Conference on Disarmament**

("Russia and China Warn of New Arms Race in Space," Reuters, 5-11-99)

"[T]he very direction of the current actions of the US Senate is in itself a step towards destroying the ABM Treaty and with it all agreements on limiting strategic missiles.... [The ABM Treaty and START Treaties] are composite parts of an integral whole.... We are talking here of a serious threat to the whole process of limiting nuclear weapons and to the stability of a strategic situation which has taken decades of international agreements to build up."

—**Russian Foreign Ministry Statement**

(*Agence France Presse*, 3-18-99 and *Reuters*, Moscow, 3-18-99)

"... all agreements that have been signed or are being prepared will come under threat—namely START I, START II, and consultations on START III."

—**Col. Gen. Vladimir Yakovlev, commander of Russia's strategic rocket forces**

(Barry Renfrew, "Russia Fears US Proposal Could Lead to Arms Race," *Pacific Stars and Stripes*, 10-19-99)

"We will fully withdraw from all inspection measures and will not let anyone close to our arms. Russia will not know what is going on in the United States. Americans will not know what is going on in Russia."

—**Col. Gen. Vladimir Yakovlev, commander of Russia's strategic rocket forces**

("Russia Warns of US Arms Race," Associated Press, Moscow, 10-5-99)

"Problems have cropped up now with the Russian-American 1972 ABM treaty; for this reason, we are forced to build in into our new missiles a capability for penetrating anti-missile defenses."

—**Col. Gen. Vladimir Yakovlev, commander of Russia's strategic rocket forces**

("But We Make Missiles," *Izvestia*, 6-5-99, p. 1)

If the United States deploys a missile defense system, Russia "will be forced to raise the effectiveness of its strategic nuclear armed forces and carry out several other military and political steps to guarantee its national security under new strategic conditions. ... We see no variants which would allow the United States to set up a national ABM system and still preserve the ABM treaty and strategic stability in the world."

—**Gregory Berdennikov, director of the Russian Foreign Ministry's Security and Disarmament Department**

(David Hoffman, "Moscow Proposes Extensive Arms Cuts," *Washington Post*, 8-20-99, p. 29)

measures (decoys, chaff, jammers, etc.), to ensure that its warheads could penetrate the NMD system with high probability. Indeed, recent statements indicate that Russia plans to deploy countermeasures on its Topol-M ICBM in response to the planned NMD system.⁸ While such countermeasures would not make the Russian

nuclear arsenal more dangerous or lethal, they would negate any protection the NMD system otherwise would have afforded against accidental, erroneous, or unauthorized Russian attacks.

Second, Russia could rely more heavily on its ability to launch its missiles on warning of an attack. Because only a small fraction of the Russian nuclear force could survive a US attack, Russia reportedly maintains an option to launch most of its vulnerable

⁸ David Hoffman, "Russian Rocket Called Invincible," *Washington Post*, 25 February 1999, p. 19.

missiles—silo-based ICBMs, garrisoned mobile ICBMs, and pierside submarine-launched ballistic missiles—on warning of attack. This is particularly dangerous given the fragmentation and degradation of Russia's attack warning system, the generally poor state of military training and morale, and the potential for a serious political crisis. Deploying an NMD system would only reinforce Russian plans to launch its missiles on warning. Thus, on balance, deploying an NMD system could actually *increase* the risk of accidental, inadvertent, or unauthorized launch.

Third, Russia could maintain a larger number of ballistic-missile warheads that it otherwise would have. Although Russia's economic difficulties preclude a major missile-building program, Russia could maintain a much larger number of warheads at relatively low cost by renouncing the START II Treaty (which it has signed but not ratified), which prohibits multiple-warhead land-based missiles. Russia could, for example, extend the life of its existing large, multiple-warhead ICBMs or fit its newer land-based missiles with multiple warheads. As we discuss in Chapter 2, Russia can likely maintain 3,000 to 4,000 strategic warheads for the next decade or more.

Fourth, Russia could emphasize alternative means of delivering nuclear weapons. For example, Russia could rehabilitate its strategic bomber force, or it could redeploy long-range land-attack cruise missiles on ships or submarines. (All US and Russian nuclear sea-launched cruise missiles are currently in storage as a result of coordinated US and Russian unilateral reductions of nonstrategic weapons in the early 1990s.) This option is less likely than those presented above, given Russia's historical emphasis on land-based ballistic missiles, but risks to US security could increase if Russia goes down this path. These forces are more vulnerable to theft or unauthorized use than are ICBMs, which are under tight central control.

Finally, Russia could deploy an NMD system of its own, partly for reasons of parity and prestige. Although many analysts would dismiss this possibility, given Russia's economic situation, Russia's experience with missile defense is comparable to that of the United States, and it would be able to deploy an NMD system at a cost far below that of the planned US system. Russia almost certainly would use nuclear-armed interceptors in such a system, which would have a higher kill probability and would be less susceptible to countermeasures than the hit-to-kill interceptors planned by the United States. Although a Russian NMD system would not threaten the United States directly, it

undoubtedly would trigger US countermeasures and Russian counter-countermeasures that would renew the nuclear arms race and leave both countries less secure. The ABM Treaty's prohibition on nationwide defense was intended to prevent this sort of action-reaction syndrome.

In addition to its effect on Russia's nuclear force posture, a US NMD system would affect US-Russian relations more generally. The Clinton administration's stance on missile defenses and the hostile or dismissive attitude towards Russia expressed by factions in the US Congress has strengthened xenophobic forces in Russia. A US decision to deploy an NMD system, whether accompanied by US withdrawal from the ABM Treaty or by exploiting Russia's weak position to compel its agreement to treaty modifications that are contrary to its interests, is bound to lead to a deterioration of US-Russian relations. It can be expected that reactionary forces in Russia would use this issue to advance their agenda.

A deterioration of relations could curtail or reverse cooperative efforts to reduce nuclear risks. This could include failure to implement the START II Treaty and the collapse of the START process, renunciation of unilateral agreements to reduce nonstrategic nuclear weapons, and termination of a variety of existing assistance programs, officer exchanges, transparency measures, and inspection arrangements. Russia's massive stockpile of nuclear materials, weapons, and delivery systems and its numerous scientists and engineers with expertise in sophisticated military technology will continue to pose a risk of proliferation of both materials and expertise to other countries as long as Russia's economy remains poor and its political climate turbulent. A deteriorating US-Russian relationship would preclude the cooperation essential to reduce this proliferation risk, which poses a vital threat to US security.

A deteriorating US-Russian relationship could also make Russia more willing to sell missile components, missiles, and countermeasures to emerging missile states, resulting in an increased missile threat to the United States from other countries. Indeed, as the 1999 National Intelligence Estimate (NIE) notes, the likelihood that China or Russia would transfer an ICBM to another country in the next 15 years depends in part on their "perceptions of US ballistic missile defenses."⁹

⁹ National Intelligence Council, "National Intelligence Estimate (NIE): Foreign Missile Development and the Ballistic Missile Threat to the United States Through 2015," unclassified summary, September 1999, p. 12.

Chinese Statements on NMD

"If a country, in addition to its offensive power, seeks to develop advanced TMD or even NMD, in an attempt to attain absolute security and unilateral strategic advantage for itself, other countries will be forced to develop more advanced offensive missiles. This will give rise to a new round of arms race, and will be in nobody's interest... After the Cold War, with the world moving rapidly towards multi-polarity, the significance of ABM Treaty has increased rather than decreased."

—**Ambassador Sha Zukang, Director-General,
Department of Arms Control and Disarmament,
Ministry of Foreign Affairs of China**

(Statement at Carnegie Endowment
7th Annual International Nonproliferation Conference,
Washington, D.C., 1/11–1/12/99)

"Any amendment, or abolishing of the [ABM] treaty, will lead to disastrous consequences. This will bring a halt to nuclear disarmament now between the Russians and Americans, and in the future will halt multilateral disarmament as well."

—**Ambassador Sha Zukang, Director-General,
Department of Arms Control and Disarmament,
Ministry of Foreign Affairs of China**

(John Pomfret, "China Warns of New Arms Race,"
Washington Post, 11-11-99, p. 1)

"Progress in nuclear disarmament cannot be achieved without a global strategic equilibrium and stability. The research, development, deployment and proliferation of sophisticated anti-missile systems and the revision of, or even withdrawal from, the existing disarmament treaties on which global strategic equilibrium hinges will inevitably exert an extensive negative impact on international security and stability and trigger off a new round of arms race in new areas, thereby seriously obstructing or neutralizing international efforts of nuclear disarmament and nuclear non-proliferation."

—**Chinese President Jiang Zemin**

(Speech at Conference on Disarmament,
Geneva, 3-26-99)

"This decision [to proceed with plans for ballistic missile defenses] will have profound negative influence on the global and regional strategic balance and stability and trigger a new round of arms race to the detriment of the international disarmament process."

—**Li Changhe, Chinese Ambassador
to the UN Conference on Disarmament**

("Russia and China Warn of New Arms Race in
Space," Reuters, 5-11-99)

China

As discussed in Chapter 2, China deploys some two dozen single-warhead silo-based missiles and one submarine capable of carrying ballistic missiles. China has no intercontinental bomber force. It does not maintain its strategic nuclear forces on alert, ready to launch on short notice. Thus, China does not have a truly survivable deterrent force, as that concept is understood by the other nuclear powers. China apparently believes that ample warning of an attack would be available and that the mere possession of nuclear weapons, together with the fact that an attacker could not be confident that it could destroy all of China's weapons and prevent retaliation against one or more of its cities, is sufficient to deter nuclear coercion by the United States and Russia.¹⁰

¹⁰ For a discussion of China's nuclear doctrine, see Alistair Johnstone, "China's New 'Old Thinking': The Concept of Limited Deterrence," *International Security*, Vol. 20, No. 3 (Winter 1995-96), pp. 5–42; Yang Huan, "China's Strategic Nuclear Weapons," *Defense Industry of China, 1949–1989*

Given the size and the vulnerability of China's strategic nuclear forces, any concerns that might be aroused in Russia by a US NMD deployment would hold far more strongly for China. Although a nation that possesses a thousand nuclear warheads for delivery by long-range missile might tolerate the planned NMD system, a nation with two dozen warheads is highly unlikely to do so. Moreover, while the Clinton administration is seeking to assure Russia that the planned NMD system would not threaten the Russian nuclear deterrent, the system is designed and intended to be able to defend against an attack by tens of missiles, which is the size of China's ICBM force. It is reasonable to expect that China would respond to the deployment of an NMD system so as to maintain, in the eyes of US political

(Beijing: National Defense Industry Press, 1989), available at www.fas.org/nuke/guide/china/doctrine/huan.htm; and Paul Godwin and John J. Schulz, "Arming the Dragon for the 21st Century: China's Defense Modernization Program," *Arms Control Today* (December 1993), p. 6.

and military decision makers, the deterrent capability of China's nuclear forces.

In fashioning its response, China has two basic options: deploying countermeasures or increasing the size of its nuclear force by deploying more missiles and/or deploying multiple warheads on missiles. A launch-on-warning posture is not a realistic option for China because it has no attack warning system and because even a full-scale Chinese attack would be unable to overwhelm the proposed NMD system unless China also employed countermeasures or increased the number of warheads. Given China's historical emphasis on ballistic missiles, it is also unlikely that China would develop alternative means of delivery, such as long-range air- or sea-launched cruise missiles.

We believe that a buildup and modernization of China's ICBM force is a likely consequence of a US decision to deploy NMD. China may already plan to modernize its force to improve its survivability and lethality, but the timing and scale of the buildup would almost certainly be affected by a US NMD deployment. If, as seems likely, China's strategic arsenal would remain significantly smaller than those of the United States and Russia, a buildup would not materially alter the existing strategic balance. However, those who believe that the proposed NMD would fundamentally shift the strategic balance in favor of the United States, freeing the United States to act with impunity against China's perceived vital interests, are engaged in wishful thinking. China has the resources, knowledge, and incentive to maintain a credible strategic deterrent into the foreseeable future, and there is every indication that it will do just that.

To maintain an ability to increase the size of its arsenal, China may refuse to agree to end the production of fissile material for nuclear weapons. China may also fail to ratify the Comprehensive Test Ban Treaty, particularly given the rejection of that treaty by the US Senate, or may even resume nuclear testing in order to develop countermeasures to the NMD system or warheads for multiple-warhead missiles.

As with Russia, US deployment of an NMD system would strain US-China relations. Because the United States needs China's cooperation in limiting missile proliferation, a deterioration in US-China relations may also lead to an increased missile threat from other countries.

Emerging Missile States

The primary mission of the NMD system is to defend US territory against a small number of ICBMs armed

with nuclear or biological warheads launched by emerging missile states, such as North Korea, Iran, and Iraq. As discussed in previous chapters, any such state could employ one or more effective countermeasures to defeat the NMD system if it wanted to use long-range ballistic missiles. Here we consider other possible responses that an emerging missile state could take to an NMD system. Several of these are elaborated in Chapter 2.

One possibility is to use ship-launched cruise missiles to deliver a nuclear or biological weapon. As the Ballistic Missile Defense Organization has disclosed in considerable detail, the United States does not have anything approaching a reliable defense against ship-launched cruise missiles.¹¹ Indeed, the Rumsfeld Report noted that cruise missiles have a number of characteristics that make them increasingly attractive to emerging missile states.¹² Today dozens of developing nations own tens of thousands of conventionally armed anti-ship cruise missiles, which could be converted to land-attack missiles and armed with a small but deadly payload of biological agent.¹³ It would be easier to develop or acquire short-range ship-launched cruise missiles with a large enough payload to deliver a nuclear weapon than it would be to develop or acquire ICBMs.

Another reason a nation might choose to use cruise instead of ballistic missiles is the difficulty of establishing the identity of the ship from which a cruise missile was launched with sufficient confidence to permit retaliation. There are over 100,000 merchant ships with a displacement of over 100 tons, and every day about 1,000 such ships cross into the area of the Atlantic Ocean within 1,000 miles of US shores. Low-flying cruise missiles are difficult to detect and track. By contrast, the launch point of any ballistic missile, whatever its range, would be identified by US satellite sensors.

A second alternative is to launch short-range ballistic missiles from ships off the US coast—a possibility that is mentioned in both the Rumsfeld Report and the 1999 NIE. Any state that could deploy an interconti-

¹¹ R. Ritter, National Cruise Missile Defense Briefing, May 1998.

¹² Executive Summary, *Report of the Commission to Assess the Ballistic Missile Threat to the United States*, July 1998, p. 2. Referred to hereafter as the Rumsfeld Report. The summary is available online on the Federation of American Scientists website at www.fas.org/irp/threat/bm-threat.htm.

¹³ See, for example, David M. Gormley, "Hedging Against the Cruise Missile Threat," *Survival*, Vol. 40, No. 1 (1998), pp. 92–111.

mental-range ballistic missile would be capable of launching shorter-range missiles from ships at a much earlier date. Ship-launched ballistic missiles could reach large portions of the continental United States on trajectories immune to interception by the planned NMD system or air defenses, and such missiles could be considerably more accurate than an ICBM.

A third possibility is to use covert delivery methods, such as sailing a merchant ship into a harbor, using civilian aircraft, or smuggling a weapon into the United States. As the 1999 NIE notes, such delivery options would be more reliable and accurate than ICBMs deployed by emerging missile states and would probably “be more effective for disseminating biological warfare agent than a ballistic missile.”¹⁴ In addition, a first-generation nuclear weapon may be too large and heavy for delivery by a long-range ballistic missile available to an emerging missile state, but would be suitable for delivery by ship, truck, or airplane. And because an emerging missile state would likely have only a few nuclear weapons, it would want a reliable means of delivery.

In short, ICBMs are not required to attack the United States with nuclear or biological weapons. For developing countries in particular, ship-launched cruise or ballistic missiles or clandestine delivery present a far easier and surer road to such a capability than do ICBMs.

Proponents of NMD agree that other modes of delivery are possible, but they maintain that this does not negate the value of an NMD system. Deploying an NMD system would, however, exact an opportunity cost. Defense spending is limited; spending money on one thing means that money will not be spent on something else. If, as seems likely, deploying an NMD system would preclude the large expenditures required to defend against non-ICBM modes of delivery, while simultaneously increasing the likelihood that an attacker would choose one of these alternative modes, then an NMD system would leave the United States more vulnerable to attack.

Other States

The effects of a US decision to deploy an NMD system would reverberate throughout the international system. For example, if China responds by building up its nuclear force, this could trigger the deployment of

nuclear-armed missiles by India and, in turn, Pakistan. Similarly, a decision by China to reject a fissile-material cutoff or the Comprehensive Test Ban Treaty would preclude participation by India and Pakistan and would doom these agreements.

If the deployment of a US NMD system resulted in a halt in US-Russian arms control efforts and a Chinese buildup, as seems likely, this would undermine the nuclear nonproliferation regime. States that agreed not to acquire nuclear weapons under the Non-Proliferation Treaty (NPT) did so under the condition, in Article VI of the treaty, that the nuclear weapon states would pursue negotiations leading to nuclear disarmament. The nuclear weapons states reiterated this commitment in connection with the indefinite extension of the treaty in 1995. The first post-extension review of the treaty, scheduled to take place this year, is expected to focus almost exclusively on the extent to which the nuclear weapon states are meeting their Article VI commitments.

Even key US allies, such as the United Kingdom, France, and Germany, are uneasy about US plans to deploy a national missile defense. European leaders have reportedly told US officials of their concerns that deploying NMD would decrease international security by prompting Russia and China to pull out of arms control treaties. They have also warned that it would complicate relations within NATO.¹⁵ (See box on Allied Statements on NMD.)

Conclusions

The proposed US NMD system would decrease the security of the United States. Russia and China would respond to the deployment of such a system by deploying a greater number of warheads than otherwise planned. In addition, Russia would likely increase its reliance on launch-on-warning to ensure that any retaliatory strike would be large enough to overwhelm the NMD system. A decision to deploy an NMD system would also have a generally negative effective on US relations with Russia and China and would threaten cooperative efforts to decrease the number of nuclear weapons, improve controls on weapons and weapon materials, and combat proliferation. Finally, an NMD system could prompt emerging missile states to concentrate on other modes of delivery.

¹⁴ National Intelligence Council, “NIE: Foreign Missile Development,” p. 15.

¹⁵ See, for example, William Drozdiak, “Possible US Missile Shield Alarms Europe,” *Washington Post*, 6 November 1999, p. 1.

Allied Statements on US NMD Plans

"If you start this [NMD], you're starting the arms race back up."

—**NATO official**

("A Case of the Jitters," Paul Bedard, *US News & World Report*, 12-13-99, p. 12)

"If only one side, the United States, begins to step up [defense capabilities], a Cold War atmosphere will be created."

—**Jonathan Motzfeldt, prime minister of Greenland's home rule government**

("Greenland Says Russia Must Back US Missile Plan," Reuters, Copenhagen, 11-3-99)

"Great care should be taken not to damage a system that, for almost 30 years, has underpinned nuclear restraint and allowed nuclear reductions."

—**Lloyd Axworthy, Canadian Foreign Affairs Minister**

("Canada Stuck in Nuclear Squabble," Mike Trickey, *The Ottawa Citizen*, 11-17-99, p. A13)

"The Americans are obviously prepared to take advantage of Russia's present weakness to realize their own national interests.... America's current arms policy is nothing less than an affront: The ABM treaty is being called into question, spending for the NMD anti-missile system is being more than doubled. This means that Russia is no longer accepted as a partner in security policy. And this thoughtlessness on Washington's part hurts Russia's self-esteem, which ultimately only strengthens the nationalists and national communists."

—**Gernot Eler, Deputy Chair of the SPD Group in the German Bundestag**

(*Deutsches Allgemeines Sonntagsblatt*, 2-5-99, p. 8)

"We already went through this debate during the 1980s with Ronald Reagan and the idea of a 'Star Wars' anti-missile system. We learned how dangerous and divisive it can be when you tamper with the ABM treaty, and that is one thing that has not changed since the end of the Cold War."

—**Senior NATO official**

("Possible US Missile Shield Alarms Europe," William Drozdiak, *Washington Post*, 11-6-99, p. 1)

"This project destabilizes the present situation. By questioning the ABM Treaty, we are moving directly from non-proliferation to counter-proliferation.... But where are the potential aggressors? Why should rogue states not be persuaded by the logic of deterrence?... Might this system not trigger a new arms race, raising the risk of proliferation in unstable regions of the world?... We would like this project to be studied quietly, and without any premature decisions. But it concerns the whole world."

—**Gen. Jean-Pierre Kelche, French chief of defense staff**

("French Army Chief Rejects Washington's Fears of a NATO Split," Carey Schofield, *London Daily Telegraph*, 11-23-99)

"We must avoid any questioning of the ABM treaty that could lead to disruption of strategic equilibria and a new nuclear arms race."

"If you look at world history, ever since men began waging war, you will see that there's a permanent race between sword and shield. The sword always wins. We think that these systems are just going to spur swordmakers to intensify their efforts."

"China, which was already working harder than we realized on both nuclear weapons and delivery vehicles for them, would of course be encouraged to intensify those efforts, and it has the resources to do so. India would be encouraged to do the same thing, and it, too, has the resources. And it would also increase tensions within NATO, which would be too bad."

—**French President Jacques Chirac**

("US and NATO Allied Divided Over Defense Needs," Craig R. Whitney, *New York Times*, 12-3-99, p. A6, and "With a 'Don't Be Vexed' Air, Chirac Assesses US," Craig R. Whitney, *New York Times*, 12-17-99)

"We are worried the Americans are going to ruin the Anti-Ballistic Missile treaty, and then the whole deck of cards would tumble down."

—**European defense official**

("Europe Disputes Need for Ballistic Missile Defense," Colin Clark and Luke Hill, *Defense News*, 12-13-99, pp. 3, 28)

Chapter 13

Deterrence and Diplomacy

Previous chapters have shown that the planned NMD system would be ineffective at defending the United States against even limited attacks by long-range ballistic missiles, whether launched by emerging missile states, Russia, or China. Nor would any national missile defense address the threats posed to the United States by other means of delivering nuclear, biological, or chemical weapons. As discussed in Chapter 2, several other means of delivery are far less demanding technically and more accurate than are long-range missiles, and would therefore offer an attacker with limited technical resources a simpler and more reliable means of attacking US territory.

The threat that the planned NMD system is intended to counter is not new. For decades the United States relied on deterrence to cope with the far graver threat to its very survival posed by Soviet nuclear-armed missiles. Deterrence will continue to be the ultimate line of defense against attacks using weapons of mass destruction.

The harsh truth that the planned NMD system would not be effective means that the United States must continue to respond to the threat of missile attack in other ways. The United States, in concert with other countries, can continue to reduce the missile threat through a combination of export controls and various cooperative measures and agreements. If preventive policies fail, and a hostile emerging missile state obtains intercontinental-range missiles armed with nuclear, chemical, or biological weapons, the United States could deter the use of such weapons through the threat of overwhelming retaliation. If such a state makes an explicit and credible threat to launch a missile attack against the United States, it may be possible to destroy its missiles before they are launched, in accord with the right of self-defense.

In addition, a rational approach to national security would impel the United States to pursue research and development programs that would address the most plausible means that emerging missile states could use to deliver nuclear, biological and chemical weapons—not just long-range ballistic missiles.

In this study, we do not examine in detail alternative means of addressing the missile threats that the NMD system is intended to defend against. However, for completeness, in this chapter we briefly review some of the other means by which the United States can address the missile threat from emerging missile states such as North Korea, Iran, and Iraq, and from Russia and China.

Emerging Missile States

For the emerging missile states, a major barrier has been the acquisition of long-range missiles or the technology to build them.

Export Controls. The centerpiece of efforts to prevent the acquisition of missile technology is the Missile Technology Control Regime (MTCR). The MTCR is a voluntary arrangement to control the export of missiles and missile technologies, components, and production facilities. The regime began in 1987 and today 29 countries are members.¹ There are also

¹ As of March 1998, members were Argentina, Australia, Austria, Belgium, Brazil, Canada, Denmark, Finland, France, Germany, Greece, Hungary, Iceland, Ireland, Italy, Japan, Luxembourg, The Netherlands, New Zealand, Norway, Portugal, the Russian Federation, South Africa, Spain, Sweden, Switzerland, Turkey, the United Kingdom, and the United States. Nonmember states that have agreed to adhere to MTCR guidelines include Bulgaria, China, the Czech Republic, Israel, Poland, Romania, the Slovak Republic, South Korea, and Ukraine.

export control regimes to limit the spread of nuclear, chemical, and biological weapons.

Export controls have slowed proliferation substantially over recent decades, reducing to a handful the number of countries that might acquire intercontinental-range missiles and nuclear weapons. Export controls deter countries from attempting to build missiles and buy time against those that try.² Nevertheless, export controls have not prevented proliferation altogether: North Korea, Iran, and Iraq are believed capable of developing long-range missiles in the near future, and India, Israel, and Pakistan have nuclear weapons. In some cases, supplier governments are unwilling or unable to enforce controls. For example, there is strong evidence that Iran received advanced missile technology from firms in Russia, despite Russia's membership in the MTCR and repeated assurances by the Russian government that it would prevent such transfers. Iraq also demonstrated that a determined country can develop weapons of mass destruction through a combination of indigenous programs and circumvention of export controls.

Export controls cannot be effective without the cooperation of Russia and China, and their willingness to cooperate will be undermined by the US deployment of a national missile defense system.

Cooperation. Cooperative policies, such as security assurances and various economic or diplomatic measures, can give countries powerful incentives to voluntarily abandon, curtail, or reorient their weapons programs or deployments, or never to begin such programs. This strategy has often been successful in the past, and its future potential is substantial.³

Even countries that are hostile to the United States may be willing to reduce the threat they pose to the United States, given the proper incentives.⁴ For

example, in 1994 North Korea agreed to verifiably freeze and ultimately eliminate its plutonium-production program in exchange for two nuclear power reactors and other assistance. According to press reports, North Korea has indicated on several occasions its willingness to end missile exports in exchange for aid.⁵ North Korea might also be persuaded to end the development and testing of new, longer-range missiles. Following former Secretary of Defense William Perry's trip to North Korea in the spring of 1999 and the US announcement that it would ease some economic sanctions, North Korea agreed to observe a moratorium on missile flight tests as long as discussions on these issues with the United States were continuing.

Deterrence. Despite the best efforts of the United States, it may not be able to prevent or dissuade some countries from acquiring long-range missiles. Nevertheless, if any emerging missile state were to use, or threaten to use, such missiles against the United States, it would have to disregard the fact that the United States is by far the world's strongest military power with an unquestioned ability to destroy the government of such a state.

Indeed, the United States has made it clear that it will exploit its power as a deterrent against emerging missile states. For example, during the 1991 Persian Gulf War, General Colin Powell threatened to destroy Iraq's ports, highways, railroads, airlines, oil facilities, and, if necessary, the dams on the Tigris and Euphrates rivers if Iraq used chemical and biological weapons.⁶

States to be pragmatic than sanctimonious. In fact, the United States has a long history of attempting to modify the interests of other states through a variety of incentives and disincentives.

² See, for example, David Wright "The Case for Engaging North Korea," *Bulletin of the Atomic Scientists*, March/April 1999, pp. 54–58, and Korean Central News Agency (KCNA) commentary, "Nobody Can Slander DPRK's Missile Policy," 16 June 1998.

³ For example, in exchange for compensation from Russia and various incentives from the United States, Belarus, Kazakhstan, and Ukraine returned former Soviet nuclear weapons to Russia following the breakup of the Soviet Union. Also, South Korea and Taiwan abandoned their nuclear weapons programs (in the late 1970s and 1980s, respectively) when it became clear that continuing them would jeopardize continued US economic engagement and security cooperation.

⁴ Such incentives are sometimes characterized as "bribery" or "rewards for bad behavior," but it is better for the United

² In the cases of Argentina and Brazil, for example, export controls hindered the development of long-range missiles and nuclear weapons, allowing time for civilian governments to come to power in 1983–85 and put an end to these weapons programs.

³ For example, in exchange for compensation from Russia and various incentives from the United States, Belarus, Kazakhstan, and Ukraine returned former Soviet nuclear weapons to Russia following the breakup of the Soviet Union. Also, South Korea and Taiwan abandoned their nuclear weapons programs (in the late 1970s and 1980s, respectively) when it became clear that continuing them would jeopardize continued US economic engagement and security cooperation.

⁴ Such incentives are sometimes characterized as "bribery" or "rewards for bad behavior," but it is better for the United

Some NMD proponents, including Secretary of Defense Cohen, argue that the United States needs an NMD system because emerging missile states might threaten to attack the United States with long-range missiles to deter it from using conventional forces to intervene in a regional conflict.⁷ For example, North Korea might threaten to attack the United States if it moved to defend South Korea against an invasion by the North. In the Cold War, however, even the massive Soviet nuclear arsenal did not deter the United States from promising to defend its European allies against a Soviet conventional attack. Although this promise was never put to the test, Soviet and European leaders alike considered it credible.

Nevertheless, there may indeed be situations in which such a threat of attack would influence US decision-making, and it would be preferable if such situations never arose. However, a US NMD system would not ease this problem because US leaders could not be confident that the NMD system would be effective. If US leaders were unwilling to take action that might prompt a ballistic missile attack on the United States without an NMD system, they would also be unwilling to do so with this NMD system.

Prelaunch Destruction. During a pre-existing state of war, or if an emerging missile state made an explicit and credible threat to attack the United States with long-range missiles carrying weapons of mass destruction, the United States could try to destroy the missiles and their launchers before they could be used. A first-generation intercontinental-range ballistic missile would be liquid-fueled and large. Such missiles would not be mobile. Their location would likely be detected by US satellites and other intelligence-gathering means. While the United States failed during the 1991 Gulf War to locate and destroy any of Iraq's mobile launchers for its short-range Scud missiles, this failure does not indicate that the United States could not destroy long-range missiles deployed by emerging missile states on receipt of strategic warning of their launch. Moreover, while the Rumsfeld Commission judged that the *development* of long-range missiles could escape detection for a longer period than had previously been assumed, that does not mean that US

intelligence satellites could not detect the *deployment* or launch preparation of such missiles.

Of course, prelaunch destruction would be an act of war, and it might be difficult for the United States to decide to preempt even if hostilities had broken out. The ambiguities that always attend decisions in a crisis would, in this circumstance, be dominated by the uncertainty about the reliability of intelligence and would not be resolved by a missile defense of dubious effectiveness. If a credible threat was made to launch weapons of mass destruction at US territory, preemption would be a serious option—one that an emerging missile state could not ignore and which would be a strong deterrent in itself.

Boost-Phase Defenses. A boost-phase defense system designed to destroy missiles very early in their flight would be less vulnerable to countermeasures than the planned US NMD system.⁸ By destroying missiles in their boost phase before submunitions could be released, such defenses could also be effective against missiles carrying biological or chemical agents.⁹ However, it should not be assumed that planned US theater missile defenses could provide a basis for a boost-phase defense against long-range missiles.

A boost-phase missile defense could use very fast interceptors deployed in underground silos or on offshore platforms. Because an interceptor would only have a short time to reach the missile during its boost phase, a boost-phase defense could only intercept missiles that were launched from points relatively close to the interceptor sites (perhaps within a distance of a thousand kilometers) and from over a relatively small area. Consequently, the system might work against geographically small emerging missile states, but could not provide a boost-phase defense against missiles launched from large countries such as Russia or China.

⁷ See, for example, Secretary of Defense William B. Cohen, Testimony to the Senate Armed Services Committee, 8 February 2000. See also, Jim Garamone, "Missile Defense Would Counter Nuclear Blackmail," American Forces Press Service, 7 February 2000, and William Safire, "Team B vs. CIA," *New York Times*, 20 July 1998, p. A15.

⁸ Countries seeking to defeat a boost-phase defense could try to reduce the duration of the boost phase of their missiles, but doing so would require developing advanced solid-fueled missiles, which are quite different from the liquid-fueled missiles that are now the foundation of the missile programs in North Korea, Iran, and Iraq.

⁹ Richard L. Garwin, "The Wrong Plan," *Bulletin of the Atomic Scientists*, March/April 2000, pp. 36–41, and Richard L. Garwin, "Cooperative Ballistic Missile Defense," presented at the US State Department Secretary's Open Forum on National Missile Defense Against Biological and Nuclear Weapons, 18 November 1999 (available online on the Federation of American Scientists website at www.fas.org/rlg/991117.htm).

Deploying such a system would likely face significant policy obstacles. Deployment could raise significant concerns in Russia and China, which might be concerned that the United States could retrofit the fast interceptor boosters with kill vehicles intended for midcourse interception, making the system capable of engaging long-range missiles launched from anywhere in Russia or China. Moreover, basing the defense close enough to some emerging missile states would be a challenge, although this would not be the case for North Korea.

Russia and China

Nuclear-armed Russian missiles on rapid-launch status are a real and present danger to the security of the United States. China also has a small force of nuclear-armed missiles capable of striking US territory. In the case of Russia, the threat of deliberate attack has receded, but this has been superseded by the danger of accidental, erroneous, or unauthorized launch. Moreover, as noted in the previous chapter, US deployment of an NMD system may lead Russia and China to react in ways that increase the threat that their missiles pose to the United States. For example, Russia may increase its reliance on a “launch-on-warning” policy, and China may deploy many more warheads than it otherwise would have.

Russia. Only cooperation can reduce the risk of accidental, erroneous, or unauthorized launch of Russian missiles. Accidental launch cannot be deterred. US security is inextricably linked to the proper management of Russia’s nuclear forces. US-Russian cooperative programs are needed to prevent unintended launches, and to reduce the risk that Russian nuclear weapons, weapon materials or weapon know-how might be stolen or sold. However, US NMD deployment is likely to make such cooperation much more difficult.

The risk of accidental, erroneous, or unauthorized launch of Russian missiles could be reduced through a variety of cooperative measures to reduce the size and launch-readiness of missile forces. The current situation, in which both countries stand ready to launch thousands of nuclear warheads in a few minutes, is exceedingly dangerous. Deterrence requires the ability to retaliate, not the ability to retaliate instantaneously. To reduce the risk of accidental, unauthorized and erroneous attack, both countries could take their vulnerable forces (silo-based missiles, garrisoned mobile missiles, and pier-side sub-launched missiles), or all their nuclear missile forces, off rapid-launch alert status.

In the case of the United States, which has a large number of invulnerable sea-based warheads, nuclear deterrence would be robust even if all of its nuclear weapons were incapable of immediate launch. This is less clearly so for Russia, which has a smaller number of warheads survivably deployed at any given time. Thus, even more so than for the United States, Russian willingness to take weapons off rapid-launch status would depend on the state of relations between the two countries. The US deployment of an NMD system would not only damage such relations, but would likely be viewed as a threat to the utility of Russia’s survivable nuclear forces. Its deployment may, therefore, lead Russia to increase the fraction of its forces ready for immediate launch.

Another cooperative approach for dealing with accidental, erroneous, or unauthorized launches would be to install postlaunch nuclear-warhead destruction devices on all ballistic missiles.¹⁰ Such destruction devices are used in tests of US missiles for safety purposes. In this case the devices would be installed on the warheads rather than the missiles so that they could be used even after the warhead was released from the missile.

China. As with Russia, the only practical way to deal with the Chinese missile threat is through a combination of deterrence and cooperation.

Cooperative measures can reduce the Chinese missile threat. China has at times in the past been reluctant to engage in arms control negotiations because its nuclear force is much smaller than those of the United States and Russia and less capable than those of France and Britain. But China joined the other nuclear-weapon states in signing the Comprehensive Test Ban Treaty and submitted it to the National People’s Congress for ratification even after the US Senate voted the treaty down in October 1999.¹¹ China also joined the four other nuclear-weapon states in an informal freeze on the production of fissile material for weapons, pending the negotiation of a formal convention. China may also be willing to join in other arrangements that the other four original nuclear-weapon states found mutually agreeable.

¹⁰ Sherman Frankel, “Aborting Unauthorized Launches of Nuclear-Armed Missiles Through Postlaunch Destruction,” *Science and Global Security*, Vol. 2 (1990), pp. 1–20.

¹¹ “China Submits N-Test Ban Treaty to Parliament,” Reuters, 1 March 2000.

Appendix A

The Thermal Behavior of Objects in Space

“Due to their extended time above the earth’s atmosphere, strategic RVs [reentry vehicles] are much colder (emit less IR [infrared] signal) than the TBMs [theater ballistic missiles]...”

—General Malcolm O’Neill, then Director of the Ballistic Missile Defense Organization, in a hearing before the Military Acquisition Subcommittee of the House Armed Services Committee, 1993

It is a common misperception that—because space is cold—an object initially at room temperature will cool in space. However, this is true only at night (that is, when the object is in the Earth’s shadow). Only then will the equilibrium temperature of any object in space be well below room temperature. During the daytime, the equilibrium temperature can be either above or below room temperature.

One of the physical observables that the NMD system will use to try to discriminate the warhead from other objects in space is temperature. This appendix provides background information on the thermal behavior of objects in space and their equilibrium temperatures.

It is convenient to discuss the thermal behavior of objects in space by first considering a theoretical object that absorbs all radiation incident upon it. Such an object, known as a “blackbody,” is also a perfect emitter of radiation.

The Physics of a Blackbody

The emission of radiation from a blackbody is described by a number of well-known physical relationships. For a blackbody at a temperature T (all temperatures are given in Kelvin, K), the spectral radiant exitance $M_\lambda(T)$ (the amount of energy per second emitted by a unit area of the object’s surface with wavelength in a unit bandwidth centered at wavelength λ) is given by Planck’s formula:

$$M_\lambda(T) = \frac{2\pi hc^2}{\lambda^5 \left[e^{\frac{hc}{\lambda kT}} - 1 \right]} \quad (\text{A-1})$$

where h is Planck’s constant (6.6×10^{-34} J-s), c is the speed of light (3×10^8 m/s), and k is Boltzmann’s constant (1.38×10^{-23} J/K). M_λ is also sometimes called the “emittance.” Figure A-1 shows the spectral radiant exitance of a 300 K blackbody as a function of wavelength.

The wavelength at which the spectral radiant exitance is a maximum depends on the temperature of the blackbody and is given by the Wien Displacement Law:

$$\lambda_{\text{MAX}} = 2898/T \quad (\text{A-2})$$

where λ is given in microns (μm), if T is in Kelvin.

The sun, with a surface temperature of about 6,000 K, thus has its peak in the visible at a wavelength of about 0.5 μm , while a 300 K room temperature object has its peak in the long-wave infrared at a wavelength of about 10 μm . Thus for an infrared sensor searching for or observing room temperature objects, it is desirable for it to have a peak sensitivity near 10 μm .

The total radiant exitance $M(T)$ emitted by an object at temperature T can be obtained by integrating the spectral radiant exitance over all wavelengths. It is given by the Stefan-Boltzmann formula:

$$M(T) = \sigma T^4 \quad (\text{A-3})$$

where σ is the Stefan-Boltzmann constant (5.67×10^{-12} W/cm²-K⁴). For a 300 K blackbody, this gives $M = 0.046$ W/cm².¹ If the blackbody were a missile warhead with a surface area of 4 m², the total power

¹ It is customary in infrared engineering to use units of W/cm², and we follow that convention here.

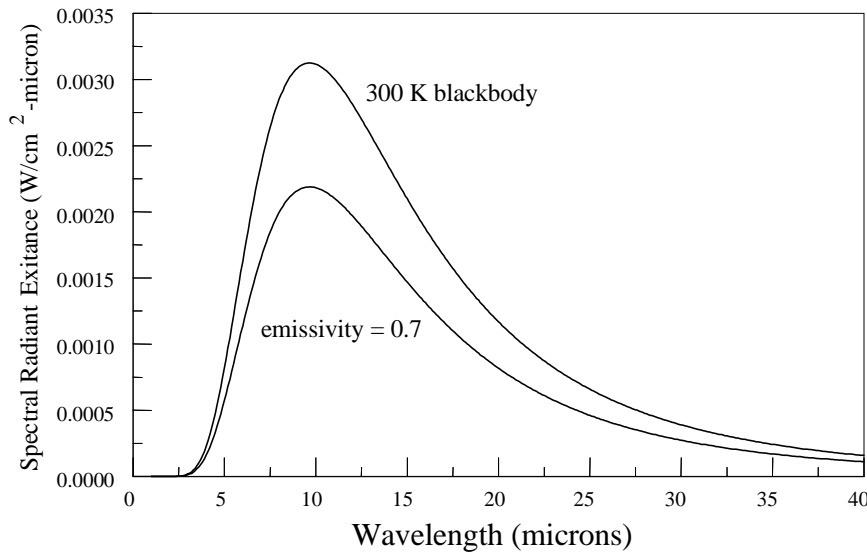

Figure A-1. The spectral radiant exitance of two objects as a function of wavelength: a 300 K blackbody, and a 300 K graybody with an emissivity of 0.7.

emitted by the warhead would be 1,840 watts (or about 146 W/steradian).

To obtain the power emitted in a spectral band, M_λ is integrated over that wavelength band. For example, the power emitted by a 300 K blackbody in the long-wave infrared band from 8 to 12 μm is 0.0124 W/cm^2 . The power emitted in this wavelength band by a warhead with a surface area of 4 m^2 is about 500 watts.

The Physics of a Graybody

A blackbody is a perfect absorber and emitter of radiation. Actual targets, of course, will not be perfect absorbers and emitters. At a given temperature and wavelength, the ratio of the spectral radiant exitance, M_λ , of an object to that of a blackbody is known as the emissivity ϵ of the object:

$$\epsilon(\lambda, T) = \frac{M_\lambda(T)_{\text{object}}}{M_\lambda(T)_{\text{blackbody}}} \quad (\text{A-4})$$

If the emissivity of an object is constant as a function of wavelength and temperature, then it is known as a graybody (a blackbody is thus a graybody with $\epsilon = 1$). For a graybody, all the relationships (A-1) through (A-3) presented above still apply, but with the emissivity as an additional multiplicative factor. Thus for a graybody, the Stefan-Boltzmann relationship is

$$M(T) = \epsilon \sigma T^4 \quad (\text{A-5})$$

Figure A-1 also shows the spectral radiant exitance for a 300 K graybody with $\epsilon = 0.7$. Note that the curves are identical except that the radiant exitance of the graybody is reduced by a factor of 0.7 relative to that of the blackbody.

If the warhead discussed above, with a surface area of 4 m^2 , had an emissivity of 0.8, then it would emit a total power of about 1,470 watts and about 400 watts in the 8 to 12 μm band.

While a blackbody is a perfect absorber of radiation, a graybody is not. At a given temperature and wavelength, the ratio of the radiation absorbed by a graybody to that absorbed by a blackbody is

given by the absorptivity α .

For objects in thermal equilibrium,

$$\alpha = \epsilon \quad (\text{A-6})$$

For an opaque object, energy not absorbed must be reflected, and so the reflectivity ρ is given by:

$$\rho = (1 - \alpha) = (1 - \epsilon) \quad (\text{A-7})$$

where the second equality assumes thermal equilibrium.

The Physics of Real Targets

A real target, although it may behave like a graybody over a limited range of wavelengths (for example, over the visible or the long-wave infrared part of the spectrum), will have an emissivity that varies with wavelength. Thus, although at any given wavelength

$$\epsilon(\lambda_1) = \alpha(\lambda_1) \quad (\text{A-8})$$

in general

$$\epsilon(\lambda_1) \neq \epsilon(\lambda_2) \quad (\text{A-9})$$

and therefore

$$\epsilon(\lambda_1) \neq \alpha(\lambda_2) \quad (\text{A-10})$$

In particular, the absorptivity at visible wavelengths, which largely determines how much radiation a target in space in daylight will absorb, can be very different from the emissivity at long-wave infrared (LWIR) wavelengths, which largely determines how much radiation the target will emit. Materials with different

visible absorptivities and LWIR emissivities make possible a wide range of target equilibrium temperatures in space.

Equilibrium Temperatures in Space. For an object in thermal equilibrium in space,

$$P_E = P_A + P_I \quad (\text{A-11})$$

where P_E is the power emitted by the object, P_A is the power absorbed by the object, and P_I is any power generated internally by the object (for example, by a warhead inside a balloon). For the discussion here we will neglect P_I (although we will consider this term when we discuss balloon decoys in Appendix H, which is on the thermal effect of a warhead in a balloon), so that $P_E = P_A$.

Objects in daylight. For a balloon illuminated by the sun and in equilibrium at a temperature T_{eq} ,

$$P_E = A_S \epsilon_{IR} \sigma T_{eq}^4 \quad (\text{A-12})$$

and

$$P_A = A_C [(S + S_R)\alpha_V + \alpha_{IR}E] \quad (\text{A-13})$$

where A_S and A_C are the surface area and average cross-sectional area of the balloon, ϵ_{IR} is the emissivity averaged over the infrared (IR) band, σ is the Stefan-Boltzmann constant ($5.67 \times 10^{-12} \text{ W/cm}^2\text{-K}^4$), S is the solar flux (1360 W/m^2), S_R is the solar flux reflected from the Earth (known as the albedo flux and typically taken to be equal to $0.3S$), E is the Earth infrared flux (about 240 W/m^2), α_V is the balloon absorptivity averaged over the visible and near infrared band, and α_{IR} is the balloon absorptivity averaged over the infrared band.² (Note that equation (A-12) assumes that the balloon is rotating so that all of its surface is equally exposed to the sun and its temperature is constant over the surface; this obviously can be only approximately true.)

Using the fact that $\alpha_{IR} = \epsilon_{IR}$ for an object in thermal equilibrium, equation (A-13) can be rewritten as

$$P_A = A_C [(S + S_R)\alpha_V + \epsilon_{IR}E] \quad (\text{A-14})$$

² The values of the albedo flux and the Earth IR flux are those appropriate for an object at altitudes of several hundred kilometers (that is, in low Earth orbit). At higher altitudes, these fluxes will be lower. Both fluxes are proportional to $[1 - (1 - k^2)^{0.5}]$, where $k = R_E/(R_E + h)$, R_E is the radius of the Earth, and h is the warhead altitude. See George P. Wood and Arlen F. Carter, *Predicted Characteristics of an Inflatable Aluminized-Plastic Spherical Earth Satellite with Regard to Temperature, Visibility, Reflection of Radar Waves, and Protection from Ultraviolet Radiation*, NASA Technical Note D-115, July 1959.

By combining equations (A-11), (A-12), and (A-14) we obtain an equation for the equilibrium temperature T_{eq} , under the condition that $P_I = 0$:

$$T_{eq} = \left[\frac{(A_C / A_S) [(S + S_R)\alpha_V + E]}{\epsilon_{IR} \sigma} \right]^{1/4} \quad (\text{A-15})$$

For a spherical balloon, the ratio (A_C / A_S) is $1/4$, and equation (15) becomes

$$T_{eq} = \left[\frac{(S + S_R)\alpha_V + E}{4\sigma \epsilon_{IR}} \right]^{1/4} \quad (\text{A-16})$$

Note that T_{eq} is independent of the radius of the balloon.

Table A-1 lists visible absorptivities and infrared emissivities for a range of materials. Using the values listed for a sphere coated with white epoxy paint ($\alpha_V = 0.248$ and $\epsilon_{IR} = 0.924$), equation (A-16) yields an equilibrium temperature of 237 K. Thus, assuming the sphere coated with white epoxy paint is at room temperature (300 K) before deployment, the sphere will cool to an equilibrium temperature of 237 K if deployed during the daytime. However, if the sphere was instead painted with aluminum silicone paint ($\alpha_V = 0.25$ and $\epsilon_{IR} = 0.28$), the equilibrium temperature would be 299 K, which is near room temperature. On the other hand, a sphere covered with shiny aluminum foil ($\alpha_V = 0.192$ and $\epsilon_{IR} = 0.036$) would have an equilibrium temperature of 454 K. Table A-1 also lists the equilibrium temperatures for spheres with different surface coverings.

The temperatures in Table A-1 are computed using a solar flux of 1360 W/m^2 , an albedo flux equal to exactly 0.3 the solar flux, and an Earth infrared flux of 240 W/m^2 . In practice, each of these fluxes will vary slightly with factors such as the time of the year and time of day, so the temperatures in Table A-1 will vary, typically by several degrees, as these factors change.

Thus, depending on the surface coating used, targets in space during the daytime can have widely varying equilibrium temperatures—both above and below room temperature. In fact, one can obtain any equilibrium temperature for a sphere between 227 K and 540 K by using more than one surface coating; for example, by painting part of the surface with different paints.

Table A-1. The visible absorptivities, infrared emissivities, and their ratio, for several materials.

If a sphere (or spherical shell) is in sunlight, its surface coating will determine the equilibrium temperature. This equilibrium temperature is listed for a sphere coated with each material. If the sphere is in the earth's shadow, its equilibrium temperature will be independent of its surface coating and will be 180 K.

Surface Coating	α_V	ϵ_{IR}	α_V/ϵ_{IR}	Equilibrium Temperature of Sphere in Sunlight (K)
White TiO ₂ paint	0.19	0.94	0.20	227
White epoxy paint	0.248	0.924	0.27	237
White enamel paint	0.252	0.853	0.30	241
Mylar	0.17	0.5	0.34	247
Aluminum silicone paint	0.25	0.28	0.89	299
Grey TiO ₂ paint	0.87	0.87	1.00	307
Black paint	0.975	0.874	1.12	314
Aluminum paint	0.54	0.45	1.20	320
Aquadag paint	0.782	0.49	1.60	341
Aluminum foil (shiny side)	0.192	0.036	5.33	454
Polished gold plate	0.301	0.028	10.8	540

Sources: Absorptivities and emissivities from George J. Zissis, ed., Sources of Radiation, Vol. 1 of The Infrared and Electro-Optical Handbook (copublished by Infrared Information Analysis Center, Ann Arbor, Michigan and the SPIE Optical Engineering Press, Bellingham, Washington, 1993), p. 113; James R. Wertz and Wiley J. Larson, eds., Space Mission Analysis and Design (Norwell, Massachusetts: Kluwer Academic Press, 1991), p. 382; P.R.K. Chetty, Satellite Technology and its Applications (Blue Ridge Summit, Pennsylvania: TAB Books, 1988), p. 250; Charles V. Woerner and Gerald M. Keating, Temperature Control of the Explorer IX Satellite, NASA Technical Note D-1369, 26 April 1962, p. 25; and Robert Siegel and John R. Howell, Thermal Radiation Heat Transfer, 3rd ed. (Washington D.C.: Hemisphere Publishing, 1992), p. 1044. Values for mylar are for mylar film laminated on aluminum foil.

From equation (A-15) we see that, for an object of given shape, the equilibrium temperature is determined by the ratio of the object's solar absorptivity averaged over visible wavelengths (α_V) to its emissivity averaged over IR wavelengths (ϵ_{IR}). The larger the ratio α_V/ϵ_{IR} , the higher the equilibrium temperature T_{eq} of an object will be.

For an object that is not spherical in shape, the equilibrium temperature for a given surface composition will generally be lower than that for a sphere, since a sphere has the largest average ratio of cross-sectional

area to surface area, A_c/A_s . If a nonspherical object is rotating in such a way that an average value of A_c/A_s can be used, then its equilibrium temperature can be easily calculated from equation (A-15). For example, consider a cylinder that is 3 meters long and has a base diameter of 3 meters. For this cylinder, depending on its orientation, the ratio of its cross-sectional area to its surface area can vary between 0.167 and 0.212. If we assume an average of 0.2, equation (A-15) gives a balloon temperature of 283.7 K for a balloon surface composition that would give a temperature of 300 K for a

sphere. If the object has a shape and orientation such that an average value of A_C/A_S cannot be used, then the calculation of the equilibrium temperature is more complex (because A_C can be different for the solar and Earth radiation fluxes).

Objects at night. For an object in space in the Earth's shadow, the situation is considerably different. Since both the solar flux S and the Earth's albedo S_R are zero, in this case equation (A-15) for the equilibrium temperature reduces to

$$T_{eq} = \left[\frac{(A_C / A_S) E}{\sigma} \right]^{1/4} \quad (\text{A-17})$$

For a spherical object, equation (A-17) simplifies to

$$T_{eq} = \left[\frac{E}{4\sigma} \right]^{1/4} \quad (\text{A-18})$$

Thus, any spherical shell in low Earth orbit in the Earth's shadow will have an equilibrium temperature of about 180 K. The cylindrical object discussed above (with a length and base diameter of 3 meters) will have an equilibrium temperature of about 170 K.

Time Required to Reach Equilibrium Temperature. In actual practice, an object on a ballistic trajectory in space may or may not reach its equilibrium temperature. How quickly it does so will depend on the difference between its initial temperature at release and its equilibrium temperature, on its emissivity, and on its thermal mass. For a heavy object, such as a warhead, the time to reach equilibrium will be many hours, much longer than the time it will be in space. On the other hand, for very light objects such as balloon decoys, equilibrium could be reached in a matter of minutes.

To illustrate both the range of temperatures that can be achieved for balloons and the equilibration time, we use a simple model. Our baseline balloon model is a sphere with a 3-meter diameter and is made from a two-ply laminate consisting of a layer of 0.0001-inch-thick aluminum foil and a layer of 0.00025-inch-thick

mylar, with the aluminum on the outside (with the shiny side of the aluminum foil facing out). With an inflation pressure of 70 Pa (0.01 pounds per square inch), 12 grams of nitrogen gas would be required to inflate the balloon. This baseline balloon has a mass of about 0.5 kg and has a heat capacity of about 460 joules/K at 300 K.³

The balloon is assumed to be at a temperature of 300 K (80° F) when deployed, and for now we will assume that although the balloon's average temperature will change, the balloon's temperature is uniform over its surface. We neglect the mass and heat capacity of any paint and the inflating gas.⁴

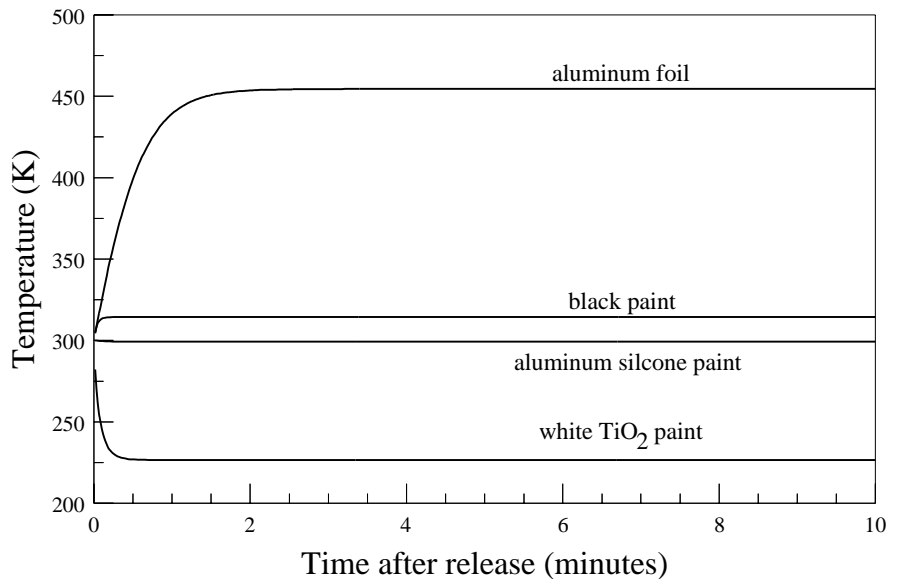

Figure A-2. The temperature of four empty balloons with different surfaces as a function of time following their release, assuming they are initially at room temperature (300 K).

The balloon with an outside surface of shiny-side aluminum foil has an equilibrium temperature of 454 K; the same balloon covered with black paint, with aluminum silicone paint, and with white TiO₂ paint has an equilibrium temperature of 314 K, 299 K, and 227 K, respectively. Our calculations assume the balloons are spherical; have a diameter of 3 meters; are made of aluminum-mylar laminate, with a 0.0001-inch-thick aluminum layer on the outside and a 0.00025-inch-thick mylar layer on the inside; and have a mass of approximately 0.5 kg. For these calculations, we also assume that although the balloon's average temperature will change, the balloon's temperature is uniform over its surface.

³ The aluminum contributes 0.19 kg and the mylar 0.25 kg (the densities of aluminum and mylar are 2.70 and 1.39 g/cm³ respectively). Their room temperature specific heats are 0.904 J/g-K for aluminum and 1.15 J/g-K for mylar. The calculations here use these room temperature values; the variation of specific heat with temperature is neglected.

⁴ For these very lightweight balloons, the mass of the paint could be a significant fraction of the balloon's total weight. However, as Figure A-3 shows for heavier balloons, this would not change the fundamental conclusion that equilibrium is reached in a few minutes.

Figure A-2 shows the temperature variation following deployment for four empty balloons with different paint finishes, with equilibrium temperatures covering a range of over 200 K: the unmodified baseline balloon with an outside surface of shiny-side aluminum foil (with an equilibrium temperature of 454 K), and the same balloon covered with a thin layer of black paint (314 K), of aluminum silicone paint (299 K), and of white TiO_2 paint (227 K). All the balloons reach their equilibrium temperatures within a minute or two.

Figure A-3 shows the thermal behavior of four spherical balloons that are the same size as those in Figure A-2, but are made of a thicker laminate, with a 0.001-inch-thick aluminum layer on the outside and a 0.001-inch-thick mylar layer on the inside. Each of these balloons has a mass of about 3 kg, or about 6.5 times that of the balloons shown in Figure A-2. Figure A-3 shows that balloons with equilibrium temperatures near room temperature still reach equilibrium within a few minutes, but the balloon with its equilibrium temperature furthest from room temperature (the aluminum foil one) takes over ten minutes to reach equilibrium.

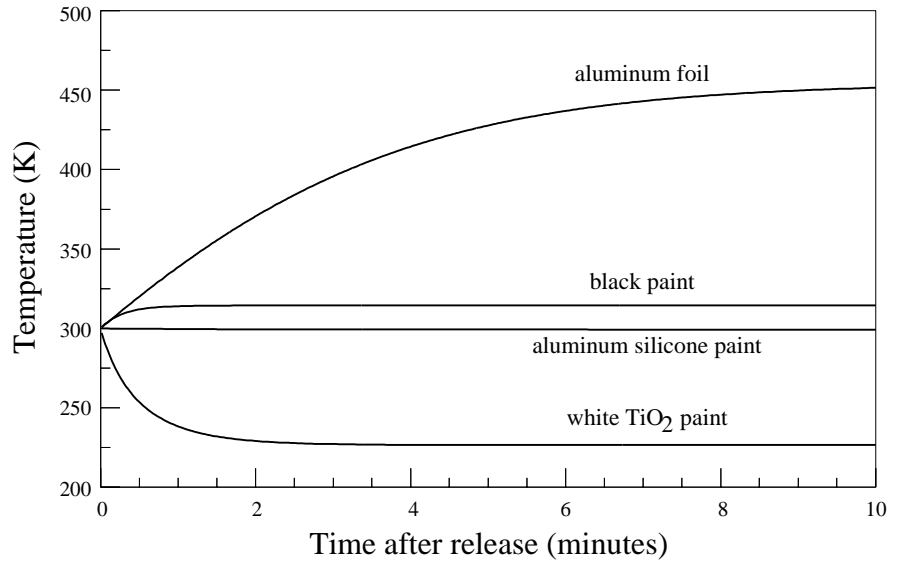

Figure A-3. The temperature of four empty balloons with different surfaces as a function of time following their release, assuming they are initially at room temperature (300 K).

The balloon with an outside surface of shiny-side aluminum foil has an equilibrium temperature of 454 K; the same balloon covered with black paint, aluminum silicone paint, and white TiO_2 paint has an equilibrium temperature of 314 K, 299 K, and 227 K, respectively. Our calculations assume the balloons are spherical; have a diameter of 3 meters; are made of aluminum-mylar laminate, with a 0.001-inch-thick aluminum layer on the outside and a 0.001-inch-thick mylar layer on the inside; and has a mass of approximately 3 kg. For these calculations, we also assume that although the balloon's average temperature will change, the balloon's temperature is uniform over its surface.

Appendix B

The Measurement and Discrimination Capabilities of SBIRS-Low

As currently planned, SBIRS-low (Space-Based Infrared System, low Earth orbit) will consist of approximately 24 satellites deployed in low-Earth orbits at an altitude of about 1,600 km. SBIRS-low will use visible and short-, medium-, and long-wave infrared sensors to track ballistic missiles throughout all phases of their flight and to discriminate the warhead from other objects. The final design of the SBIRS-low satellites is not yet set, so there could be some changes relative to the description given here.

Each satellite will have two sensors that can be aimed independently: a wide field of view acquisition sensor and a narrow field of view tracking sensor. The acquisition sensor will be a short-wave infrared sensor, which can detect a missile during its boost phase by observing its bright plume against the background of the Earth (when the missile is below the horizon), generally with the assistance of cueing information from an early warning satellite. This acquisition sensor will then hand over the targets to the tracking sensor, which can also track cooler objects by viewing them above the Earth's horizon. Our interest here is in the tracking sensor, since this is the one that would provide data for target tracking and discrimination during midcourse. The tracking sensor will be a staring sensor that will use multiple focal planes and wavelength filters to operate in different wavelength bands. The precise wavelength bands to be used by this sensor are not publicly available, but the sensor will operate in several bands spanning the following frequency ranges: visible (0.3–0.7 μm), short-wave infrared (1–3 μm), medium-wave infrared (3–6 μm), and long-wave infrared (6–16 μm).

The different spectral bands will be useful not just for observing any one object at multiple wavelengths, but also for determining an object's temperature, since

the relative amount of energy radiated by the object at different wavelengths depends on the object's temperature. The NMD system hopes to use the observed temperature of the objects it sees to distinguish the warhead from the decoys. Recall (from Appendix A) that the wavelength at which the spectral radiant exitance is a maximum, λ_{MAX} , depends on the temperature T , of a blackbody and is given by the Wien Displacement Law:

$$\lambda_{MAX} = 2,898 \mu\text{m} / T \quad (\text{B-1})$$

A room-temperature object with a temperature of 300 K thus has its peak in the long-wave infrared at a wavelength of about 10 μm . The values of λ_{MAX} and the radiation band that it falls in are given in Table B-1 for objects at various temperatures.

Table B-1. Peak radiation emitted by objects at different temperatures.

Temperature of Object (K)	λ_{MAX} (μm)	Radiation Band Used to Track Object
1000	2.9	short-wave infrared
675	4.3	medium-wave infrared
450	6.4	medium- to long-wave infrared
300	10	long-wave infrared
180	16	long-wave infrared

The short-wave infrared band can be used to track the missile during boost phase (once the acquisition sensor hands it over) as well as during reentry, once the warhead has been sufficiently heated by its atmospheric reentry. The medium- to long-wave and the long-wave infrared sensors will be of most use for tracking and discrimination in midcourse. Recall (from Appendix A) that the equilibrium temperature for an object in sunlight in space can range from roughly 240 K to over 500 K, whereas the equilibrium temperature of an object in the Earth's shadow is 180 K (although heavy objects such as warheads may not vary much from room temperature during the limited time they are in space).

The visible sensor would not detect radiation emitted from the object, but reflected sunlight. The surface temperature of the sun is about 6,000 K, corresponding to a wavelength λ_{MAX} of 0.5 μm .

Only limited public information is available about the sensitivity and resolution of the SBIRS-low sensors. However, additional insight into their likely characteristics can be obtained from looking at the Midcourse Space Experiment (MSX), which is operated by universities and about which detailed technical information is available. MSX is a BMDO-sponsored satellite intended to support the development of space-based infrared satellites such as SBIRS-low. Because MSX is a state-of-the-art system intended to measure target and background signatures and this information will be fed directly into the SBIRS-low program, it is reasonable to assume that the angular resolution and sensitivity of SBIRS-low sensors will be similar to those of the MSX sensors.¹

It is also possible to determine some properties of the SBIRS-low sensors using basic physical principles. Below we discuss and analyze the available information to assess the capability of SBIRS-low to make thermal and visible measurements on objects in space during midcourse and to use this data to discriminate warheads from other objects.

¹ According to then-director of BMDO General Malcolm O'Neill, "MSX will collect infrared, visible, and ultraviolet data on exoatmospheric targets and backgrounds to validate models and sensor designs. MSX will also demonstrate target acquisition and tracking, verify the sensor's ability to track targets against stressing backgrounds, and demonstrate state-of-the-art sensor and spacecraft technologies. MSX data will be used to determine how an infrared tracking sensor in space hands off state vectors to an exoatmospheric kill vehicle (EKV) so that the EKV can best guide itself to the target." BMDO Director General Malcolm O'Neill, written response to a question, House Department of Defense Appropriations for 1995, 15 March 1994, p. 224.

Medium- to Long-Wave Infrared and Long-Wave Infrared Sensors

Sensor Resolution. According to the laws of physics, the diffraction-limited angular resolution of a sensor is given by λ/d , where λ is the wavelength of the radiation the sensor detects and d is the diameter of the sensor aperture. For a medium-wave infrared sensor with an aperture diameter of 0.5 meters, the diffraction-limited angular resolution would therefore be roughly $4\mu\text{m}/0.5\text{m} = 8 \mu\text{rad}$.² At a target range of 1,000 km, its resolution would be about 8 meters.³ For a long-wave infrared sensor with the same aperture diameter, the diffraction-limited angular resolution would instead be roughly $10\mu\text{m}/0.5\text{m} = 20 \mu\text{rad}$. At a target range of 1,000 km, its resolution would be about 20 meters.

Thus the spatial resolution of the medium- to long-wave and long-wave infrared sensors will be too poor to allow any imaging of a warhead-sized object (with dimensions of roughly 2 meters); instead these sensors will see all midcourse objects as point emitters. The sensors will also be unable to resolve closely spaced objects and will therefore not be able to observe the deployment of countermeasures (such as balloons) in any detail.

We can compare these numbers with information about the MSX Spatial Infrared Imaging Telescope III (SPIRIT III). SPIRIT III is a mid- through long-wave infrared sensor, detecting radiation with wavelengths from 4.2 to 26.0 μm .⁴ Its primary components are an imaging telescope, a six-color radiometer, and a six-channel interferometer/spectrometer. It is cooled by

² We use an aperture of 0.5 meter for several reasons. The MSX sensor, which we assume will be similar to the SBIRS-low sensor, has an aperture of about 0.39 m. Assuming a larger sensor is a conservative estimate since it will underestimate the diffraction effects. BMDO drawings of SBIRS-low satellites show small apertures, so this appears to be a reasonable estimate. Moreover, our analysis does not depend sensitively on this value, since the aperture would have to be roughly an order of magnitude larger to be able to image any structural details of targets.

³ If we assume SBIRS-low has 24 satellites that are evenly distributed and deployed at an altitude of 1,600 kilometers, then the average spacing between satellites would be about 6,500 kilometers.

⁴ Brent Y. Barschi, David E. Morse, and Tom L. Woolston, "The Spatial Imaging Telescope III," *Johns Hopkins APL Technical Digest*, Vol. 17, No. 2 (1996), pp. 215–224; A.T. Stair, Jr., "MSX Design Parameters Driven by Target and Backgrounds," *Johns Hopkins APL Technical Digest*, Vol. 17, No. 1 (1996), pp. 11–17.

solid hydrogen to temperatures between 10 and 20 K. Its primary collection mirror has a diameter of 38.63 cm. The radiometer has an angular resolution of 90 μrad , which is somewhat larger than the diffraction limit of 67 μrad for its longest wavelength of 26 μm . The corresponding spatial resolution is 90 meters at a range of 1,000 kilometers.

Detection Range. Published data on the expected performance of the SBIRS-low long-wave infrared sensor indicates that it can detect an asteroid emitting about 6×10^8 W/steradians at a range of 100 million kilometers.⁵ This corresponds to a flux density at the sensor aperture of 6×10^{-18} W/cm². The article does not specify the signal-to-noise ratio (S/N) used, but indicates it gives a high probability of detection (P_d). The nominal integration time was also not specified; however, the single-look probability of false alarm (P_{fa}) was said to be under 2 percent. For $P_{fa} = 0.01$,⁶

$$\begin{aligned} P_d = 90\% & \text{ requires } S/N = 5.4 \\ P_d = 95\% & \text{ requires } S/N = 10.2 \\ P_d = 97\% & \text{ requires } S/N = 16 \end{aligned}$$

If we assume that the probability of detection is at least 95 percent, then a signal-to-noise ratio of at least 10 is required. Under this assumption, we can determine the Noise Equivalent Flux Density (NEFD) of the sensor, which is a measure of its sensitivity and is defined as the incoming infrared power per unit area at the aperture that would give a signal-to-noise ratio of 1 at the sensor. Thus, the NEFD at the aperture would be approximately 6×10^{-19} W/cm².

We can now compare this value of the NEFD based on data about the SBIRS-low long-wave infrared sensor with the values for the MSX sensors. Information about the six different MSX Spirit III sensor bands is given in Table B-2.

Since the SBIRS-low long-wave infrared sensor detects radiation in the 6–16 μm band, the MSX sensor bands of interest are A, C, and D. Note that the Band A sensor has a noise-equivalent flux density of 6.0×10^{-19} W/cm², which is the same value as we estimated above based on the asteroid detection capabilities of SBIRS-

Table B-2. The six different MSX sensor bands.

Name of Band	Wavelength of radiation detected (μm)	Noise Equivalent Flux Density (W/cm ²)
A	6.0–10.9	6.0×10^{-19}
B1	4.22–4.36	6.6×10^{-18}
B2	4.24–4.45	5.7×10^{-18}
C	11.1–13.2	1.6×10^{-18}
D	13.5–16.0	2.0×10^{-18}
E	18.3–26.0	11×10^{-18}

Data taken from A.T. Stairs, Jr., "MSX Design Parameters Driven by Targets and Backgrounds," John Hopkins APL Technical Digest, Vol. 17, No. 6 (1996), pp. 11–17.

low. However, the NEFD for Bands C and D are somewhat higher, by a factor of three to four. Because a smaller value of the NEFD indicates a greater sensor sensitivity, we will make the assumption that the NEFD of the SBIRS-low sensor is the smallest of these values, 6.0×10^{-19} W/cm².

Now that we have a value for the NEFD of the sensor, we can calculate the range R at which the sensor would detect an object that emits a total amount of power P in the 6–16 μm band:

$$R = \sqrt{\frac{P}{4\pi(\text{NEFD})(S/N)}} \quad (\text{B-2})$$

where S/N is the required signal-to-noise ratio. From numerical integration of Planck's formula, we find that a room temperature (300 K) warhead with a surface area of 4 m² and an infrared emissivity of 0.9 emits about 950 watts in the 6–16 μm band. If we require the S/N to be 10, then equation (B-2) yields a detection range of about 35,000 kilometers.

In general, against a cold space background, the sensitivity of the SBIRS-low sensor appears to permit the detection of room temperature, high- to middle-emissivity, warhead-size objects at ranges of several tens of thousands of kilometers.

⁵ Robert P. Wright and Charles P. Hoult, "The Space and Missile Tracking System Contribution to Planetary Defense: Detection of Asteroids and Comets with Earth-Crossing Orbits," *Proceedings of the 1996 IEEE Aerospace Applications Conference*, Vol. 4 (1996), pp. 193–203. Note that Space and Missile Tracking System is the previous name of SBIRS-low.

⁶ See chart in S.A. Hovanessian, *Introduction to Sensor Systems* (Norwood, Mass.: Artech House, 1988), p. 182.

Visible Light Sensor

SBIRS-low will also have a visible light sensor that would detect the sunlight reflected by an object. Thus, this sensor is basically sensitive to the quantity

$$\rho_v A = (1 - \epsilon_v) A \quad (\text{B-3})$$

where A is the target cross-sectional area, ρ_v is its reflectivity in the visible band, and ϵ_v is its emissivity in the visible band.

Sensor Resolution. For an aperture with a diameter of 0.5 meters, the diffraction-limited angular resolution of the visible sensor (λ/d) would be 1 μrad , corresponding to a spatial resolution of 1 meter at a range of 1,000 kilometers. This would be insufficient to make out any structural details of a warhead-sized target, although it might provide some rough information on its overall shape. However, there is reason to believe the resolution of the visible sensor is likely to be much larger than 1 μrad . The MSX visible light sensor—the Space-Based Visible (SBV) Sensor—has an angular resolution of 60 μrad . This corresponds to a spatial resolution of 60 meters at a range of 1,000 kilometers, although it may be able to interpolate positions to about one-third of the resolution. Another factor to consider is the jitter stability of MSX sensors during a typical integration period, which is $\pm 9 \mu\text{m}$, corresponding to a resolution of 18 m at a range of 1,000 km.

Thus, unless both the angular resolution and the jitter stability of the SBIRS-low visible sensor are two orders of magnitude better than those of the MSX Space-Based Visible Sensor, SBIRS-low will be unable to measure any structural details of a warhead-sized target. And it is very unlikely that the SBIRS-low visible sensor would differ significantly from the MSX visible sensor; MSX is an important part of the risk-reduction process for SBIRS-low, so it would not make sense for MSX to measure backgrounds on a scale so different from that of the SBIRS-low sensor.

Detection Range. The MSX Space-Based Visible Sensor is expected to be able to detect low-altitude targets (with a tangent altitude of 100 kilometers) at a range of 6,000 kilometers, if their reflectivity-area product, $\rho_v A$, is from 0.1 to 0.35 m^2 (corresponding to a warhead-sized target with a relatively low reflectivity).⁷ For targets viewed against deep space, the detection ranges would be several times greater.

⁷ David C. Harrison and Joseph C. Chow, "The Space-Based Visible Sensor," *Johns Hopkins APL Technical Digest*, Vol. 17, No. 2 (1996), pp. 226–235.

SBIRS-Low Measurements of Targets in Space

Detection of Targets. As we noted above, a room temperature (300 K) warhead with a surface area of 4 m^2 and an infrared emissivity of 0.9 emits about 950 watts in the 6–16 μm band. The total power received by the sensor, P_s , is:

$$P_s = (\pi d^2/4)(1/R^2)P_T \quad (\text{B-4})$$

where d is the diameter of the sensor optics, R is the range to the warhead, and P_T is the power emitted by the target warhead in the radiation band being used. If we assume that the SBIRS-low long-wave infrared sensor is observing the warhead at a range of 2,000 kilometers, then for a value of $d = 0.5 \text{ m}$, we get $P_s = 3.7 \times 10^{-12}$ watts, corresponding to a flux density of about $1.9 \times 10^{-15} \text{ W/cm}^2$.

Assuming that the target is being observed against a black space background, such signals are easily detectable by modern cooled infrared sensors. If we use the value for the noise-effective flux density that we determined above, $6 \times 10^{-19} \text{ W/cm}^2$, we would obtain a signal-to-noise ratio of better than 3,000.

Temperature Measurements. Because SBIRS-low will use several different infrared wavelength bands, it will be possible for the NMD system to estimate the temperature of an object. By comparing the power of the target signal in several infrared wavelength bands, SBIRS-low will be able to perform a fit to the Planck blackbody curve to obtain an estimate of the target temperature (a temperature obtained this way is known as a color or distribution temperature). The accuracy of this measurement will depend not only on the signal-to-noise ratio, but also on how much variation there is in the emissivity of the target over the spectral ranges being used (that is, how closely the target resembles a graybody) and the amount of temperature variation over the target.

Measurements of Emissivity-Area Product. Once the NMD system estimates the temperature of an object, it is also possible to estimate $\epsilon_{IR} A$, the product of the target's infrared emissivity ϵ_{IR} and its surface area A . Using equation (B-4) above, we can estimate the power emitted by the target, P_T ,

$$P_T = (4R^2 / \pi d^2) P_s \quad (\text{B-5})$$

where P_s is the infrared signal strength measured by the sensor, R is the distance to the target (which is measured either by the ground-based radars or by triangulation between several SBIRS-low satellites), and d is

the diameter of the infrared sensor optics. The power emitted by the target is also given by

$$P_T = \sigma \epsilon_{IR} A T^4 \quad (\text{B-6})$$

where σ is the Stefan-Boltzmann constant (5.67×10^{-12} W/cm²-K⁴), and ϵ_{IR} , A , and T are the infrared emissivity, surface area, and temperature of the target, respectively. Equating equations (B-5) and (B-6), we obtain an equation for the emissivity-area product of the target as a function of measured or estimated values:

$$\epsilon_{IR} A = 4 R^2 P_S / \sigma \pi d^2 T^4 \quad (\text{B-7})$$

In the warhead example we use above, the SBIRS-low data, combined with range information, would reveal that the target was at a temperature of 300 K and was radiating 950 watts in the 6 to 16 μm band. Since a 300 K blackbody radiates 0.026 W/cm² in this band, $\epsilon_{IR} A = 3.6 \text{ m}^2$. This could be a relatively small warhead (roughly 2 meters long with a base diameter of 1 meter) with $\epsilon_{IR} = 0.9$. However, it could also be a much larger shiny aluminum sphere (for which $\epsilon_{IR} = 0.04$) with a diameter of 5.3 meters, or anything in between.

Other Measurements. By observing how the target signal varies with time, SBIRS-low could determine whether a target was tumbling and perhaps some very rough information on its shape. By observing the

target over time, SBIRS-low could also measure how the target temperature changes over time. The direction of this change would provide some information on the ratio of the visible absorptance to the infrared emissivity α_V/ϵ_{IR} , as would the rate of change (see Appendix A). The rate of temperature change may also reveal information about the heat capacity of the target or of its outer layer. For example, a light balloon decoy (with a low heat capacity) would be expected to change temperature much more rapidly than a heavy warhead.

SBIRS-low will also be able to observe the target in the visible by detecting reflected sunlight. The average intensity of this signal could provide some information on the reflectivity-area product, $\rho_V A = (1 - \alpha_V) A$, where ρ_V and α_V are the visible reflectance and absorptance of the target and A is the surface area of the target. The visible sensor might also be able to provide some information on the color of the object, and on α_V . Combining this information with the emissivity-area product ϵ_{IR} may also allow a better estimate of the size of the target.

In practice, SBIRS-low would not be the only sensor observing a target. The X-band radars would generally be able to provide good estimates of a target's size, which could then be used in conjunction with the SBIRS-low measurements.

Appendix C

The Radar Cross Section of Warheads and Other Objects

A key characteristic of any missile defense target is its radar cross section (RCS), which is a measure of the amount of energy the target will reflect back to the radar. The larger the radar cross section of an object, the more energy the object will reflect back to the radar and the greater the range at which the radar can detect it. The RCS, usually represented by the symbol σ , has dimensions of area (usually square meters). However, its value is not necessarily comparable to an object's physical dimensions. The RCS depends not only on the target characteristics and orientation but also on the radar frequency (and generally on the radar polarization).

For a given radar, the behavior of most objects' RCS will depend on which of three broad regimes the object falls in:

- (1) the high-frequency regime (where all dimensions of the object are large relative to the wavelength of the radar)
- (2) the resonance regime (where all its dimensions are comparable to the wavelength)
- (3) the low-frequency regime (where all its dimensions are small compared with the wavelength)

In addition, if one dimension of an object is very different from its other dimensions, the object might not fall into any of these categories. In that case, it would have to be treated as a special case. In this appendix we focus on the radar cross section of simple shapes that might be relevant for warheads and decoys, i.e., spheres and cones.

High-Frequency Regime

In the high-frequency regime, the radar cross section of an object tends to be dominated by specular reflections and by reflections due to edges and surface discontinuities. This will generally be the regime of interest when warheads and other objects of similar size or larger are observed by the NMD X-band radars, which operate at a wavelength of about 3 cm.

A sphere's RCS, in this regime, is independent of frequency and is given by $\sigma = \pi r^2$. For a sphere with a diameter of one meter, this gives $\sigma = 0.8 \text{ m}^2$, while for a spherical submunition with a 10-cm radius, $\sigma = 0.03 \text{ m}^2$.

However, a warhead may not be spherical in shape. A more typical conical warhead shape can result in a greatly reduced radar cross section over a wide range of viewing angles. For a flat-backed cone with a smooth metallic surface (one without discontinuities such as seams or bolt heads) viewed near nose-on, the primary sources of radar reflections are its nose and the discontinuity where the cone meets the flat back. These reflections can be greatly reduced by bringing the nose to a sharp point (with a radius small compared with the radar's wavelength) and by rounding the back end of the cone to remove the discontinuity. For example, a sharply pointed cone-sphere (a cone with its flat back replaced with a hemisphere that blends smoothly into the cone) will have a nose-on RCS given by $\sigma \approx 0.1\lambda^2$, which is about 0.00009 m^2 for an X-band radar. (In contrast, the flat-backed cone would have a nose-on radar cross section almost 10,000 times greater.) Moreover, as Figure C-1 illustrates, its RCS would not increase significantly as the radar observation angle

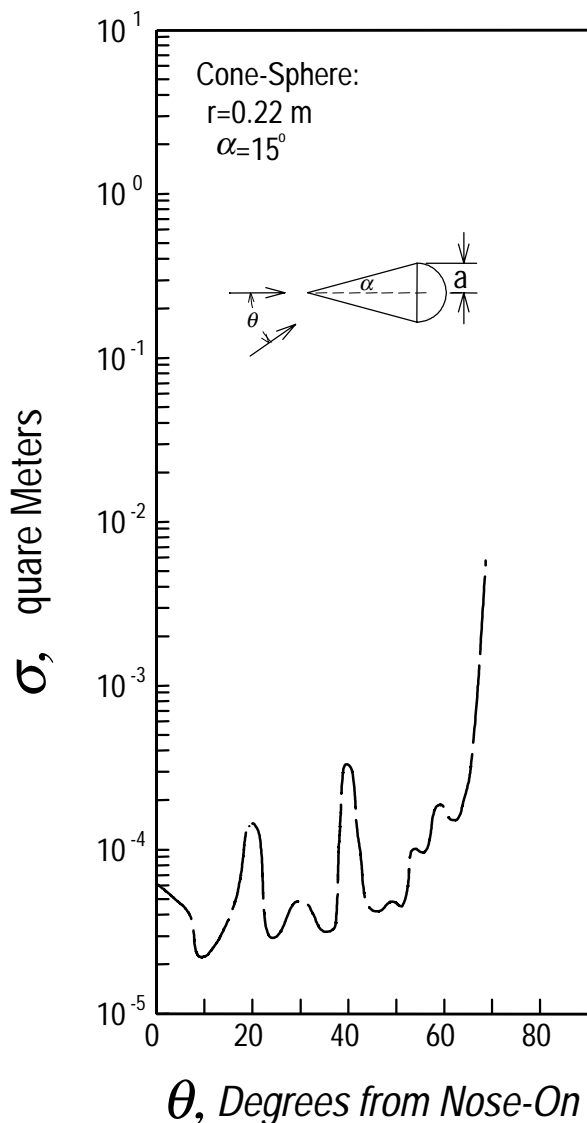

Figure C-1. Experimental measurements of the radar cross section of a cone-sphere as a function of aspect (viewing) angle θ .

The cone-sphere has a base radius of $a = 0.22$ m and a cone half-angle α of 15 degrees, and the radar wavelength is 3.1 cm (corresponding to a frequency of 9.6 GHz). The viewing angle θ is measured from a nose-on orientation. As the figure shows, the cone-sphere RCS remains small up to an angle of more than 60 degrees from nose on. The measurements are said to be accurate to $\pm 3^\circ$ in angle and $\pm 10\%$ in radar cross section. Adapted from Figure 6-30 in William D. Stuart, "Cones, Rings, and Wedges," in George T. Ruck, ed., *Radar Cross Section Handbook, Vol. 1* (New York: Plenum Press, 1970), p. 409.

changes from nose-on until it approaches an orientation nearly perpendicular to the surface of the cone. (For example, the RCS of a cone with a half angle of 15 degrees would not increase significantly until the viewing angle was more than 60 degrees from nose-on.) Thus the RCS of a warhead (or a shroud covering a warhead) could be greatly reduced by this approach, although some degree of orientation control would be required to make sure that the point of the cone was facing the radar. (The 1999 National Intelligence Estimate specifically mentions orientation control as one of the technologies expected to be available to emerging missile states for use in countermeasures.¹)

At the other extreme, relatively small objects can have relatively large radar cross sections in the high-frequency regime. A trihedral corner reflector (formed by the perpendicular intersection of three square sheets) has a maximum RCS given by $12\pi a^4/\lambda^2$, where a is the length of each side. As observed by an X-band radar, such a corner reflector with sides of length 15 centimeters can have an RCS as high as 21 m².

Thus, in the high-frequency regime, the radar cross section of an object is not necessarily comparable to its actual physical dimensions.

Resonance Regime

As the radar frequency is reduced and its wavelength increases, the details of a target's structure become less important and its RCS is increasingly determined by its overall shape and orientation. Figure C-2 shows the nose-on RCS of the cone-sphere as the radar frequency is varied.

In the resonance regime, the dimensions of the target are comparable to the radar wavelength, and its RCS will tend to oscillate as the frequency is varied due to resonant scattering effects. Missile warheads, which might typically have characteristic dimensions of 1 to 3 meters, could fall into the resonance regime when observed by US early warning radars, which operate at a wavelength of about 70 centimeters. Decoys and other missile components could also fall into this regime for those radars.

In the resonance regime, a target's RCS will be a complex function of its orientation with respect to the radar and the radar frequency. Figure C-3 shows the RCS for several objects in the resonance regime: a sphere with a one-meter diameter, a flat-backed cone

¹ National Intelligence Council, "National Intelligence Estimate (NIE): Foreign Missile Developments and the Ballistic Missile Threat to the United States Through 2015," September 1999, p. 16.

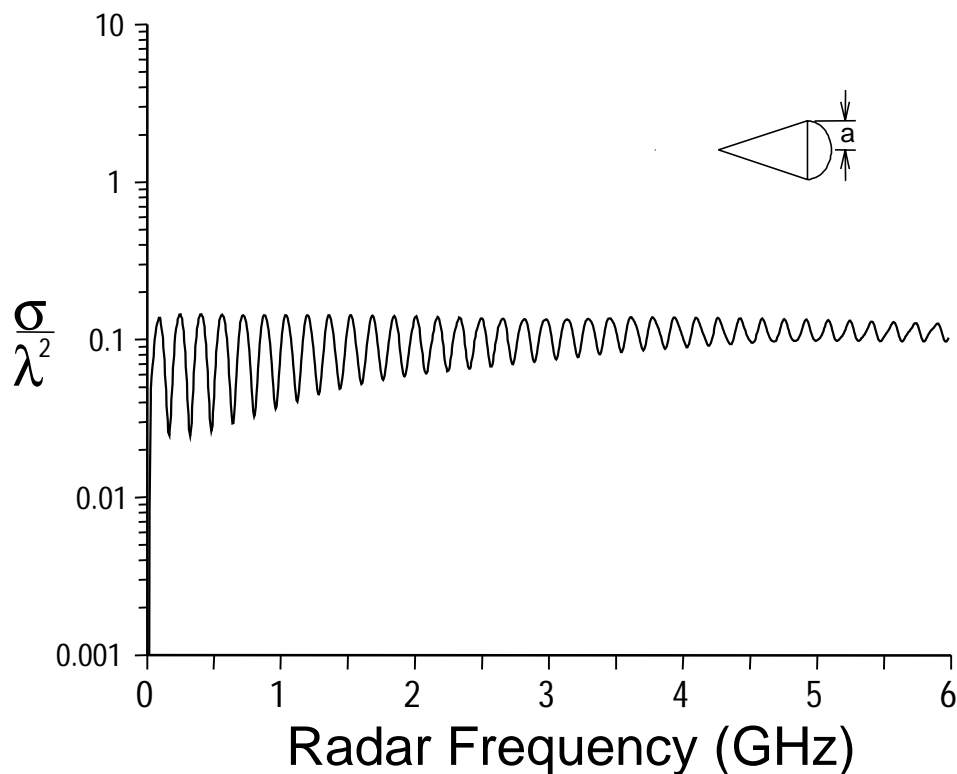

Figure C-2. Radar cross section of a sharply pointed cone-sphere as a function of radar frequency. The cone-sphere has a base radius of 0.5 m and a cone half-angle of 15 degrees as viewed nose-on by the radar. The RCS is given in terms of λ^2 where λ is the radar wavelength. At high frequencies, its nose-on RCS converges to the expected value for a sharply pointed cone-sphere of about $0.1 \lambda^2$. As the frequency is decreased, resonant scattering effects begin to produce significant variations in the cone-sphere's RCS. Curve calculated based on discussion in William D. Stuart, "Cones, Rings, and Wedges," in George T. Ruck, ed., *Radar Cross Section Handbook, Vol. 1* (New York: Plenum Press, 1970), pp. 416–420.

with a half-angle of 15 degrees and a one-meter base diameter, and a cone-sphere with the same half-angle and base diameter viewed nose-on. As the figure shows, at the frequencies used by US early warning radars, between 420 and 450 MHz, both the sphere and the flat-backed cone will have a RCS equal to about twice the square of the radar wavelength, or about 1.0 m^2 .

In the resonance regime, the RCS of a target can also be reduced by shaping, although not by as large a factor as in the high frequency regime. For example, the nose-on radar cross section of the cone can be reduced by a factor of roughly ten by making it into a cone-sphere, as shown in Figure C-3. Against the US early warning radars, the cone-sphere would have a nose-on radar cross section of roughly 0.1 m^2 —which is ten times less than that of the flat-back cone.

Moreover, a relatively small change in the diameter of the base of this cone-sphere could further reduce its RCS to about 0.02 m^2 by shifting the object from a resonance peak to a trough.

The radar cross section of the sphere obviously has no orientation dependence. However, the radar cross section of the cone-sphere and the flat-backed cone will vary with viewing angle. However, as in the high frequency case, the RCS of the cone sphere will remain relatively low for a broad range of angles around the nose-on orientation.²

²For example, see figures 6-51 and 6-52 in William D. Stuart, "Cones, Rings, and Wedges," in George T. Ruck, ed., *Radar Cross Section Handbook, Vol. 1* (New York: Plenum Press, 1970), p. 431.

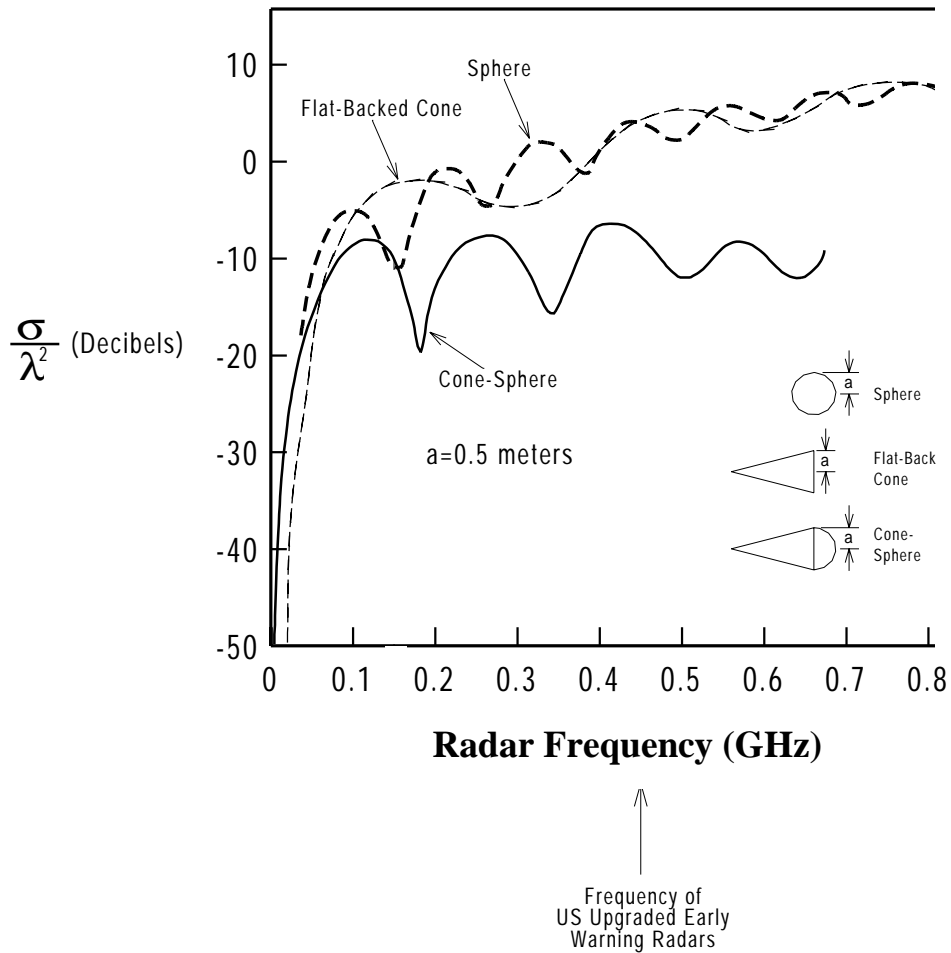

Figure C-3. RCS in resonance regime as a function of radar frequency.

The radar cross section σ as a function of frequency of a sphere, a flat-backed cone and a cone-sphere viewed nose-on. The RCS is given in terms of λ^2 , where λ is the radar wavelength. The half-angle of the flat-backed cone and cone-sphere is 15 degrees, and the radius of the sphere and base radius of the cone is 0.5 meters. Adapted from Figure 6-55 in William D. Stuart, "Cones, Rings, and Wedges," in George T. Ruck, ed., Radar Cross Section Handbook, Vol. 1 (New York: Plenum Press, 1970), p. 433.

Low-Frequency Regime

If an object falls into the low-frequency regime (sometimes referred to as the Rayleigh scattering regime) its radar cross section is generally small and falls off as the fourth power of the radar frequency. This falling-off of the RCS can be seen at the low frequency end of Figure C-3. For the early-warning radars currently used

by the United States, which have wavelengths of about 66 centimeters, objects with all dimensions (e.g., diameters) smaller than about 20 centimeters will fall into this regime. Because warheads and decoys would generally be larger than this, this regime is not of primary interest to us here.

Appendix D

The Measurement and Discrimination Capabilities of the NMD Ground-Based Radars

General Discussion

A radar operates by emitting a beam of radio-frequency radiation via an antenna. If this radar beam encounters an object, some of its energy will be reflected back towards the radar. If enough of this reflected energy reaches the radar's antenna, the radar will be able to detect the object and may also be able to measure its location, radial speed, and other characteristics.

Detection Range. For a radar that searches an area of sky in order to detect an object, its performance can be estimated using the surveillance radar equation:¹

$$R_D = \left(\frac{P_{av} A t_s \sigma}{4\pi N_f k_B T_0 L_S (S/N) \Omega_S} \right)^{\frac{1}{4}} \quad (\text{D-1})$$

where

- R_D = detection range
- P_{av} = average power of the radar
- A = area of the radar antenna
- t_s = search time (time it takes to scan the search area once)
- σ = radar cross section of the object
- N_f = system noise figure
- k_B = Boltzmann's constant (1.38×10^{-23} J/K)
- T_0 = reference temperature = 290 K
- L_S = radar system losses
- S/N = signal-to-noise ratio required for detection
- Ω_S = angular search area

The signal-to-noise ratio (S/N) that is required is set by two factors: the probability of detection (P_D) the system operator wants and the probability of false alarm

(P_{FA}) the system operator will tolerate.² The higher the desired detection probability and the lower the desired false alarm probability, the higher will be the required signal-to-noise ratio. For example, against a target with a non fluctuating radar cross section, a S/N ratio of 25.1 (14 dB) would give a P_D of 0.96 with a P_{FA} of 10^{-6} .³ If, however, a lower probability of false alarm was required, then choosing $P_{FA} = 10^{-10}$ for the same S/N would decrease the probability of detection P_D to about 0.62. With this lower P_{FA} , regaining a P_D of 0.96 would require increasing the signal-to-noise ratio to about 37 (15.7 dB).

Thus, for a given probability of detection and false alarm probability, equation (D-1) gives the relationship between the range at which the radar will detect the object (R_D), properties intrinsic to the radar (P_{av} , A , N_f , and L_S), radar parameters that are chosen by the operator (T_s and Ω_S), and the radar cross section of the object (σ).

The radar cross section of an object, σ , is a measure of the amount of energy the object will reflect back to the radar. The larger the radar cross section, the more energy the object will reflect back to the radar and the greater the range at which the radar can detect it. Although the radar cross section has dimensions of area (usually square meters), its value is not necessarily comparable to an object's physical dimensions. In fact, the

² The P_{FA} is the probability that a noise pulse will cross the detection threshold during a time period approximately equal to the reciprocal of the bandwidth. Since radar bandwidths are typically megahertz or greater, the P_{FA} for a radar is generally very small (Skolnik, *Introduction to Radar Systems*, p. 25).

³ Skolnik, *Introduction to Radar Systems*, p. 28. Tables or figures relating S/N , P_D , and P_{FA} can be found in many standard radar textbooks.

¹ See, for example, Merrill I. Skolnik, *Introduction to Radar Systems*, 2nd ed. (New York: McGraw-Hill, 1980), p. 64.

radar cross section depends not only on the object's size and shape and its orientation with respect to the radar, but also on the radar frequency (and in many cases the radar polarization). For more details on radar cross sections, see Appendix C. Although the radar cross section of an object will in general vary with its orientation and the viewing angle of the radar (unless the object is a sphere), equation (D-1) above assumes that σ is a constant.⁴

Equation (D-1) shows that the ability of a radar to search a given area in a given time depends primarily on the product of its average power and antenna area, $P_{av} A$, known as its power-aperture product. To maximize the detection range, a radar with the largest possible value of $P_{av} A$ is desired. Other parameters that depend on the radar design are the system noise figure (N_f), which is typically about 2, and the radar system losses (L_s), which are typically in the range of 5 to 10.

The surveillance radar equation also shows that a key parameter in determining the detection range for a given object is the size of the area in the sky the radar must search, Ω_s . The size of the required search area will be determined by the quality of the information about the object's trajectory that is provided to the radar by other sensors, such as early warning satellites. Such cueing data can greatly reduce the area in the sky the radar needs to search and thereby significantly increase the detection range.

Finally, equation (D-1) shows that if all other parameters are fixed, the detection range is proportional to the fourth root of the object's radar cross section.⁵

Once a radar has detected a target, it can change its operating mode to begin tracking the target by making repeated observations of it. For a radar designed primarily for a tracking role, as is likely the case for the NMD system's X-band radars, a large power-aperture

product may not be the primary concern of the radar designer, since the radar will not generally be expected to search large angular areas for potential targets.⁶ Instead, the radar design may be driven by a desire to get a narrow beamwidth to give better angular tracking capabilities which may push the radar design towards higher frequencies and larger apertures. For a ballistic target, such as a missile warhead in space, such tracking data allows the target's position, velocity, future trajectory, and other characteristics to be determined. We discuss below the measurements that a radar can make.

Radar Cross Section Measurements. A radar observing a target can measure the amount of energy returned to the radar from the target and, by using the measured target range and the known parameters of the radar, can estimate the radar cross section of the target. As discussed in Appendix C, however, this does not necessarily reveal much about the physical dimensions of the target.

Perhaps more importantly, the radar can observe how the target's radar cross section varies with time. If the target has a radar cross section that is orientation-dependent, then target motion such as tumbling or nutating about a spin axis can produce variations in radar cross section that the radar can measure. These variations may be used to deduce information about the target's shape or its dynamical behavior.

Measurement of Angular Location and Resolution. The angular width, θ_{BW} , of a radar beam is approximately given by

$$\theta_{BW} \approx \frac{\lambda}{D} \quad (\text{D-2})$$

where λ is the radar wavelength and D is the antenna diameter. Thus, the planned X-band radar, which has a wavelength of 3 centimeters and an antenna diameter of about 12.5 meters, will have an angular beamwidth of about 0.0024 radians, or 0.14 degrees. At a range of 2,000 kilometers, the beamwidth will be $(0.0024) \times (2,000 \text{ km}) = 4.8$ kilometers.

However, by observing the variation of the signal amplitude with beam position, the angular location of a target can be determined to a much greater accuracy than a beamwidth (see the box on measurement

⁴ Time variations in a target's radar cross section will generally increase the required S/N for detection if the required P_D is greater than about 0.4. There are standard models available to account for this effect. See Skolnik, *Introduction to Radar Systems*, pp. 46–52.

⁵ For a long-range surveillance radar looking for a warhead that could be approaching from anywhere in a significant angular area in the sky and that will not impact at great distance from the radar (so the warhead is approaching the radar approximately radially), the maximum detection range is obtained by taking a search time proportional to the required detection range. Thus, in this case the detection range is proportional to the cube root of the object's radar cross section. See J. C. Toomay, *Radar Principles for the Non-Specialist* (Mendham, New Jersey: Scitech Publishing, 1998), pp. 9–10.

⁶ The NMD system's upgraded early warning radars and SBIRS-low satellites will provide missile track data to the X-band radars, so these radars will not need to search large areas of the sky for targets.

accuracy and resolution). For a single pulse, the accuracy with which a target's angular position can be measured can be greater than the beamwidth by a factor of up to about $2(S/N)^{1/2}$. For typical cases, $S/N = 20\text{--}30$, resulting in an angular position measurement accuracy

roughly 10 times greater than the beamwidth. For a radar that tracks a target using many observations over a period of time, the accuracy of the angular position can be improved by—very roughly—another factor of ten. Thus, the accuracy with which a radar can measure an

Measurement Accuracy and Resolution

Measurement accuracy is determined by the precision with which a radar can determine the angular position (or range or Doppler shift) of a single target. Resolution, on the other hand, is determined by the ability of the radar to separate (resolve) two or more objects that are closely spaced in angle (or range or Doppler shift). It is sometimes surprising to those unfamiliar with radars that a radar's measurement accuracy is generally much better than its resolution. The reason this is so can be illustrated with a simple example.

The first curve in Figure D-1 shows the amplitude of the radar signal reflected off a target as a function of azimuthal angle. At $x = 0$, the radar beam is centered on the target, and at $x = \pm \theta_{BW}$, the center of the beam is offset from the target by one full beamwidth. The radar beamwidth is generally determined by the angle at which the beam power falls to one-half (3dB) its maximum at the center of the beam (and thus is known as the 3dB beamwidth). Accordingly, at $x = \pm 1/2 \theta_{BW}$, the reflected signal amplitude in the first curve in Figure D-1 is half of its peak value.

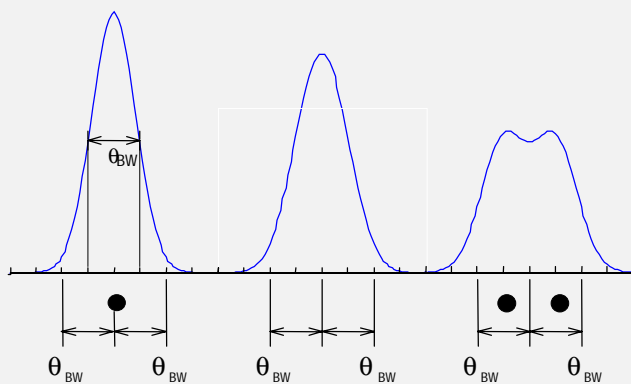

Figure D-1. The radar energy reflected off two identical targets as a function of the angular position of the center of the radar beam.

The first curve is for the two targets at the same angular position. The second curve shows the situation with the same two targets separated by one-half the 3dB beamwidth (θ_{BW}). The third curve is for the two targets separated by one full beamwidth, and shows that the radar can now determine that there is more than one target present.

However, since the radar return from a point target will vary symmetrically about its maximum value, the radar can measure the target's angular position more accurately than its beamwidth by estimating the angular position of the peak received signal. There are a number of standard techniques for doing this. The stronger the radar return signal is relative to the receiver noise, the more accurately the radar can determine the angular position of the signal's peak. Thus, the angular measurement accuracy is dependent on the signal-to-noise ratio (S/N). Provided that the S/N is high enough, a radar can measure the angular position of a target to a small fraction of its 3dB beamwidth.

Now assume the first curve in Figure D-1 represents two identical radar targets at the same angular position. Clearly, just from the shape of the curve, the radar cannot tell that more than one target is present. The second curve in Figure D-1 shows the same two targets, but now separated by one-half the 3dB beamwidth (θ_{BW}). The return signal still appears to be that of a single target. No increase in the radar S/N will help to separate these two targets, and thus the resolution is essentially independent of the S/N ratio. Finally, the third curve in Figure D-1 shows the two targets, now separated by one full 3dB beamwidth. There is now a split in the peak return signal, allowing the radar to determine that there is more than one target present. This split will become more evident as the two targets become further separated. In actual practice, the separation between two targets becomes apparent when they are separated by one 3dB beamwidth (or about λ/D), leading to equation (D-4).

Similar considerations apply to the measurement accuracy and resolution of ranges and Doppler shifts. However, it is important to remember that targets that are not resolvable in one dimension may be resolvable in another. Thus even if two objects are not resolvable based on their angular locations, a radar could determine that two targets are present if they were separated in range by more than the radar's range resolution.

object's angular position, $\delta\theta$, in a tracking mode is roughly

$$\delta\theta \approx \lambda/(100D) \quad (\text{D-3})$$

Thus, if the X-band radar in the example above, were tracking an object at a range of 3,000 kilometers a reasonable estimate is that it could determine the angular position of the object to within roughly 70 meters.

Of possibly greater interest for a discussion of countermeasures is the angular resolution of the radar, that is, the minimum angular separation between two objects that is required for the radar to resolve them as separate objects. The transverse resolution of radars is generally poor. In standard operating modes, radars cannot make measurements of the transverse dimensions of objects, nor can they distinguish separate objects at the same range unless these objects have large transverse separation distances (of at least several kilometers at ranges of thousands of kilometers).

The angular resolution of a radar, $\Delta\theta$, will be approximately equal to its beamwidth. Using equation (D-2) above, we find $\Delta\theta = \theta_{BW} = \lambda/D$. It is often more useful to express this as the resolution of the cross-range distance, ΔX , between two objects at the same range R :

$$\Delta X = (\Delta\theta) R = \theta_{BW} R = \lambda R / D \quad (\text{D-4})$$

Thus for the X-band radar above, two objects both at a range of 2,000 kilometers would have to be separated by roughly 5 kilometers or more in a cross-range direction to the beam (that is, in azimuth or elevation) for the radar to be able to distinguish them as separate objects.

Range Measurement and Resolution. In general a radar can measure the range of an object much more accurately than its angular position. By measuring the time t from when a pulse is emitted until the reflected pulse is received, the radar can measure the range R to an object by

$$R = ct/2 \quad (\text{D-5})$$

where c is the speed of light (3×10^8 m/sec).

The key parameter that determines how accurately this measurement can be made is the radar's bandwidth, β , which is basically equal to the frequency range over which the radar is able to operate. For a radar emitting a single pulse (or a series of coherently integrated pulses) of length τ , the bandwidth is given by $\beta = 1/\tau$. However, a variety of techniques, such as pulse compression, can be used to increase the pulse length while maintaining a large bandwidth. A radar can measure

the range of an object with an accuracy, δR , which is approximately given by⁷

$$\delta R \approx \frac{c}{4\beta\sqrt{S/N}} \quad (\text{D-6})$$

The X-band radar will operate at 10 GHz; if we assume its instantaneous bandwidth will be equal to 10 percent of its operating frequency, it will have a bandwidth of 1 GHz. For a typical value of S/N (say 25), equation (D-6) gives a range measurement accuracy, δR , of about 1.5 cm. Thus, such a radar could measure the range of an object (or its leading edge) to an accuracy of about 1.5 cm. By subtracting the range of the target's trailing edge, it could measure a target's radial length with a similar accuracy.

For discrimination purposes, however, the range resolution of the radar is likely to be just as or more important than its range measurement accuracy. The range resolution, ΔR , is approximately given by⁸

$$\Delta R \approx \frac{c}{2\beta} \quad (\text{D-7})$$

For a radar with a bandwidth of 1 GHz, equation (D-7) gives a range resolution of 15 cm. Thus, this radar could distinguish between two objects separated by 15 cm or more in range, or it could observe variations in the radar cross section of an object along the radial direction with a resolution of about 15 cm. Measurements of this type could potentially be important in attempting to discriminate between missile warheads and decoys, which is why radars with large bandwidths are desired for target discrimination.

Radial Velocity (Doppler) Measurement and Resolution. Although a radar could measure the radial velocity of an object (relative to the radar) by observing how its range varies with time, radial velocity can often be measured more accurately by measuring the Doppler shift of the frequency of the radar reflections due to the target motion. The size of the Doppler shift, f_D , is given by

$$f_D = 2V_R/\lambda \quad (\text{D-8})$$

where V_R is the radial velocity of the object relative to the radar and λ is the wavelength of the radar. The accuracy with which a Doppler frequency can be measured, δf_D , is given by⁹

⁷ Toomay, *Radar Principles*, p. 87.

⁸ Toomay, *Radar Principles*, p. 93.

⁹ Toomay, *Radar Principles*, p. 90.

$$\delta f_D \approx \frac{1}{2\tau\sqrt{S/N}} \quad (\text{D-9})$$

where τ is the pulse length (or the integration time for a sequence of coherently integrated pulses) and S/N is the signal-to-noise ratio. The accuracy with which the radar can measure the radial velocity of an object, δV , is thus

$$\delta V \approx \frac{\lambda}{4\tau\sqrt{S/N}} \quad (\text{D-10})$$

For example, for an X-band radar with a signal-to-noise ratio, S/N , of 25 and an integration time t of 100 milliseconds, equation (D-10) gives a radial velocity measurement accuracy of 1.5 cm/s.

The Doppler resolution, Δf , is given by

$$\Delta f \approx 1/\tau \quad (\text{D-11})$$

and the corresponding velocity resolution, ΔV , is given by

$$\Delta V \approx \lambda/(2\tau) \quad (\text{D-12})$$

where τ is the integration time. For the X-band radar example above, with $\tau = 0.1$ seconds, equation (D-12) gives a radial velocity resolution of 15 cm/s. By using a longer integration time, the radar operator could achieve an even smaller radial velocity resolution.

The Doppler resolution can be used to resolve objects that would otherwise be too closely spaced in range and azimuth to be resolvable. In practice, however, it is unclear if such a situation will occur for the situations of interest here.

Imaging Using Doppler Measurements. If a radar target, for example a warhead flying through space, is rotating, a radar can use the Doppler shifts produced by this rotation to obtain an angular resolution $\Delta\theta$ much finer than the resolution of about one beamwidth that is obtained by measuring the strength of the returned signal as function of angle. Combined with a small range resolution, this technique can be used to produce images of even warhead-size targets.

The Doppler resolution Δf is given by equation (D-11). For an object that rotates (towards or away from the radar) through an angle of $\Delta\phi$ during the integration time τ , the corresponding resolution in the cross-range direction ΔX is given by¹⁰

$$\Delta X = \lambda/(2 \Delta\phi) \quad (\text{D-13})$$

Equivalently, one can regard the rotation of the target as creating a synthetic antenna aperture on the ground of length $R\Delta\phi$, where R is the range to the target, and this technique is thus often referred as inverse synthetic aperture radar (ISAR). This synthetic aperture has a beamwidth given by $\lambda/(2R\Delta\phi)$, and the corresponding cross-range resolution is¹¹

$$\Delta X = [\lambda/(2R\Delta\phi)] R = \lambda/(2 \Delta\phi) \quad (\text{D-14})$$

which agrees with equation (D-13).

For tumbling objects, this technique can yield small cross-range resolutions. Consider a target tumbling slowly, at a rate of one revolution per ten seconds. If the radar coherent integration time τ is 160 milliseconds, then $\Delta\phi = 0.1$ radians, and the cross-range resolution is about 15 cm.¹²

If the radar making such cross-range measurements also has a small range resolution, then these range and cross-range measurements can be combined to produce a two-dimensional map or image of the target. Depending on the motion of the target, it may be possible to obtain a three-dimensional map of the target by observing it over an extended period of time.

Even if a target has a completely stable orientation in space, fine cross-range resolution can be obtained if the integration time is long enough, because its orientation will change slightly with respect to the radar. Consider a target with stable orientation and a speed of 7 km/second passing over a radar at a range of 2,000 km. In 10 seconds, it will move 70 km, and its orientation will change by an angle $\Delta\phi$ of roughly $\tan^{-1}(70/2000) = 0.035$ radians (2 degrees). For an X-band radar with a wavelength of 3 cm, using equation (D-14), we then find that the cross-range resolution is 0.43 meters.

The Measurement and Discrimination Capabilities of the NMD Radars

The planned NMD system will include up to 15 large phased-array radars: up to six early warning radars operating at 420–450 MHz, and up to nine X-band radars operating at about 10 GHz.¹³ These radars would be

¹¹ Because the synthetic aperture involves two-way propagation, the beamwidth of a synthetic aperture is half that of an actual aperture of the same length.

¹² For a warhead-sized target, going to longer integration times will not significantly improve the cross-range resolution because the Doppler shift of any given point on the object will begin to vary significantly as the orientation of the object changes.

¹³ Michael C. Sirak, "BMDO: NMD 'C3' Architecture Could Feature Up To Nine X-Band Radars," *Inside Missile Defense*, 19 May 1999, pp. 13–14.

¹⁰ Skolnik, *Introduction to Radar Systems*, pp. 528–529.

Table D-1. Characteristics and Measurement Capabilities of Current and Planned Radars

	Current PAVE PAWS (in California and Massachusetts)	Current BMEWS (in Alaska, Greenland, and Britain)	Upgraded Early-Warning Radars	X-Band Radars
Frequency (f)	420–450 MHz	420–450 MHz	Unchanged	10 GHz
Wavelength (λ)	0.67–0.71 m	0.67–0.71 m	Unchanged	~3 cm
Antenna Diameter (D)	22.1 m	25.6 m	Unchanged	12.5 m
Average Power (per face)	150 kW	255 kW	Unchanged	170 kW*
Detection Range (R_D)**	5,000 km in search mode (for object with $\sigma = 10 \text{ m}^2$)	5,000+ km in search mode (for object with $\sigma = 10 \text{ m}^2$)	5,000+ km in search mode (for object with $\sigma = 10 \text{ m}^2$)	4,000 km (target RCS not specified)
Bandwidth (β)	100 kHz (search mode); 1 MHz (track mode)	300–600 kHz (search mode); 5–10 MHz (track mode)	$\leq 30 \text{ MHz}$	1 GHz*
Range Resolution (ΔR)	1,500 m (search mode); 150 m (track mode)	250–500 m (search mode); 15–30 m (track mode)	$\geq 5 \text{ m}$	15 cm*
Angular Beamwidth (θ_{BW})	0.038 radians $= 2.2^\circ$	$\approx 2.0^\circ$	Unchanged?	$\approx 0.0024 \text{ radians}$ $= 0.14^\circ$ *
Cross-Range Resolution (ΔX) (for objects at a range of 2,000 kilometers)	75 km*	70 km*	Unchanged?	5 km

*Estimated.

**"Pave Paws, BMEWS Radar Site Updates," and Stanley Kandebo, "NMD System Integrates New and Updated Components," Aviation Week and Space Technology, 3 March 1997, pp. 47–51.

spread over a very large geographic range, possibly spanning a range from South Korea to Britain. In this section we describe the technical characteristics of these radars and assess their ability to measure and resolve the angular position, range, and velocity of objects released by a ballistic missile. A summary of this information is provided in Table D-1.

The United States currently operates a network of early warning radars located on the periphery of the United States and on foreign territory. As part of the NMD deployment, the United States plans to upgrade these radars (the PAVE PAWS and BMEWS radars described below) to enhance their capabilities.

PAVE PAWS Radars. Two PAVE PAWS early warning radars are currently operational at Otis Air Force Base on Cape Cod, Massachusetts and at Beale Air Force Base in California. These radars were completed in 1979 and 1980, respectively. Two south-facing PAVE PAWS radars, in Georgia and Texas, were subsequently built but have been deactivated and disassembled (parts from these radars are being used in the upgrade of the Clear, Alaska BMEWS radar). In addition to early warning, these radars have attack-assessment roles (counting incoming objects and predicting impact points) and are also used for space surveillance.

Each PAVE PAWS radar has two faces, each covering 120 degrees of azimuth, for a total coverage of 240 degrees.¹⁴ The PAVE PAWS radars operate in the UHF, using 24 1.2 MHz-wide frequency bands between 420 and 450 MHz (corresponding to wavelengths of 0.67 to 0.71 m). Each antenna face has a diameter of 31.1 m, although each face is only populated with active transmit/receive modules in an area with a diameter of 22.1 m. Each face contains 1,792 active modules (out of a possible total of 5,376). The noise figure for the transceivers powering the modules is 2.9 dB. The average power per face is about 150 kW, giving a power-aperture product per face of about 5.8×10^7 W-m². These radars are said to be capable of detecting a target with a radar cross section of 10 m² at a range of 5,000 km.

In the 1980s, the power-aperture product of the PAVE PAWS radars was said to be inadequate for detecting some of the longer-range Soviet SLBMs, and a

6-dB power-aperture upgrade was proposed for the Massachusetts and California radars. This upgrade would have doubled the number of modules to 3,584 and filled the entire face, thereby increasing the power-aperture product by a factor of four. A 10-dB upgrade was planned for the Georgia radar that would have allowed it to take over the mission of the FPS-85 space-tracking radar in Florida.¹⁵ This upgrade would have activated all 5,376 modules. However, none of these upgrades apparently took place. The Massachusetts and California radars underwent upgrades from 1988–1991, but publicly available information indicates that the upgrades were limited to replacing “computers, peripherals, signal processors, display consoles, and software,” and that following the upgrades, all four PAVE PAWS had identical configurations.¹⁶ Thus, the power-aperture product of the Massachusetts and California PAVE PAWS remains at its original value— 5.8×10^7 W-m².

The PAVE PAWS radars reportedly have a beamwidth of about 2.2 degrees, somewhat larger than the beamwidth of $\lambda/D = 0.031 = 1.8^\circ$ given by equation (D-2).¹⁷ (This may be due to the use of tapering to reduce sidelobes, which would broaden the main beam.) Using equation (D-4), this beamwidth gives a cross-range resolution of about 75 km at a range of 2,000 km.

The PAVE PAWS radars have a bandwidth of 100 kHz in search mode and 1.0 MHz in tracking mode.¹⁸ Thus, using equation (D-7) we find that these radars have at best a range resolution of 150 m. This poor resolution greatly limits the ability of these radars to discriminate targets from decoys. Even with upgrades to its signal processors, the greatest bandwidth achievable would be 30 MHz, since the frequency range of the radar is only from 450 to 420 MHz. From equation (D-7), we see that this imposes a fundamental range resolution limit of 5 meters, still too poor to be useful in discriminating warhead-size objects.

According to the Pentagon, the PAVE PAWS radars are currently not able to track targets with sufficient

¹⁴ Details in this paragraph are from “PAVE PAWS, BMEWS Radar Site Updates Will Broaden Missile Threat Coverage,” *Aviation Week and Space Technology*, 9 December 1985, pp. 52–54 and Michael T. Borkowski, “Solid State Transmitters,” in Merrill Skolnik, ed., *Radar Handbook, 2nd edition* (New York: McGraw-Hill), pp. 5-3, 5-25, and 5-26.

¹⁵ “PAVE PAWS, BMEWS Radar Site Updates”; Borkowski, “Solid State Transmitters,” pp. 47–51.

¹⁶ “Electronic Intelligence,” *Aviation Week and Space Technology*, 24 June 1991, p. 61.

¹⁷ Eli Brookner, “Trends in Radar Systems and Technology to the Year 2000 and Beyond,” in Eli Brookner, ed., *Aspects of Modern Radar* (Norwood, Mass.: Artech House, 1988), p. 198.

¹⁸ Marvin N. Cohen, “Pulse Compression in Radar Systems,” in Jerry L. Eaves and Edward K. Reedy, eds., *Principles of Modern Radar* (New York: Van Nostrand Reinhold, 1987), p. 475.

accuracy to guide interceptors directly. "In their current configurations, these radars can detect and develop approximate impact-location data for objects associated with a missile launch, such as the last missile stage. This information is insufficient for use by a ballistic missile defense system, for two reasons: it does not track each missile long enough before returning to the search mode, and it does not permit the derivation of sufficiently accurate trajectory parameters to support intercepts. Upgrades to the system's software, and modest changes to the hardware, are needed to address these shortfalls and to make the data so obtained available to the National Missile Defense Battle Management, Command, Control, and Communications system."¹⁹

BMEWS (Ballistic Missile Early Warning System) Radars. The United States deploys three BMEWS early warning radars: at Clear in central Alaska; at Thule, Greenland; and at Fylingdales, England. These were originally non-phased-array radars that have been replaced by phased-array radars (the Thule and Fylingdales replacements have been completed, the one for Clear is under way and is scheduled to be completed in 2001). The radars at Clear and Thule will have two faces covering 240 degrees and the Fylingdales radar has three faces covering 360 degrees. The missions of these radars are similar to those of the PAVE PAWS radars.

The new phased-array radars use the same transmit/receive modules as the PAVE PAWS radars and thus operate over the same frequency range of 420–450 MHz. The radar under reconstruction at Clear will use parts, including the transmit/receive modules, from the dismantled PAVE PAWS radars in Georgia and Texas.

Each face of the Thule BMEWS radar is 25.6 m in diameter and has 2,560 active modules.²⁰ Each face has an average power of 255 kW,²¹ yielding a per-face power-aperture product of 1.3×10^8 W-m², which is roughly twice that of PAVE PAWS. The faces of

the other BMEWS radars apparently have the same configuration.

The angular resolution of these radars is similar to that of the PAVE PAWS radars. Their range resolution is considerably better, however, since they have bandwidths of between 5 and 10 MHz in the track mode, corresponding to a range resolution of 15–30 m. However, this range resolution is still far too poor to allow any structural details of warhead-sized targets to be determined.

Upgraded Early Warning Radars. As part of NMD deployment, the BMEWS and PAVE PAWS radars will be upgraded, after which they will be referred to as Upgraded Early Warning Radars (UEWRs). These upgrades are said to involve new computers and signal processors and additional software.²² The upgrades would not involve any change to the radar's maximum power output.²³ Demonstrations showing how these radars' "detection range, sensitivity, and accuracy" could be increased have been carried out over the last several years.²⁴ In addition, the deployment of a new early warning radar in South Korea is apparently under consideration.²⁵

X-Band Radars. The X-band radars to be deployed for the NMD system will be based on the same technology used in the THAAD theater missile defense radar. In particular, these radars will use the same transmit/receive modules, which are assumed here to have a peak power of 10 watts and an average power of 2.1 watts.²⁶

The United States has built a prototype NMD X-band radar at the US missile test range on the Kwajalein Atoll. The prototype has an antenna with an area of 123 m² (and thus a diameter of about 12.5 meters). Its antenna has 16,896 transmit/receive

¹⁹ "National Missile Defense Deployment Readiness Program—'3+3'," enclosure in letter from Deputy Secretary of Defense John White to Representative John Spratt, 5 June 1995, available online at www.fas.org/spp/starwars/offdocs/w960605e.htm.

²⁰ "PAVE PAWS, BMEWS Radar Site Updates."

²¹ Part of the increase in average power relative to that of the PAVE PAWS radars comes from increasing the duty cycle of the transmitters from the 25 percent used in PAVE PAWS to 30 percent (Skolnik, *Radar Handbook*, p. 5-3).

²² Kandebo, "NMD System Integrates."

²³ Ballistic Missile Defense Organization, "Early Warning System," Fact Sheet, November 1998.

²⁴ Statement of General Lester L. Lyles, Director of the Ballistic Missile Defense Organization, Subcommittee on Research and Development, Committee on National Security, US House of Representatives, 6 March 1997.

²⁵ This radar is shown in a BMDO viewgraph: "C1/C2/C3 Architecture (U)—Preliminary," Ballistic Missile Defense Organization, 3 March 1999.

²⁶ According to a 1991 MITRE briefing, the theater missile defense version of the GBR uses 10 watt transmit/receive modules and has a duty factor of -6.7 dB = 0.21, giving an average power of 2.1 watts (Richard Davis, Bruce Deresh, Warren Fenster, and William Yoder, "Comparison of the Surveillance Capabilities of the LFA and the GBR," MITRE Briefing Slides, 4 June 1991).

modules and is reported to have a detection range of 2,000 km (although the radar cross section of the target was not specified).²⁷ However, the antenna array has fewer modules than an operational radar and reportedly has an effective aperture area of only 105 m². Assuming an average power of 2.1 watts per module, the prototype X-band radar has an average power of about 35 kW.²⁸ (It can be upgraded to the same number of modules as the X-band radars to be deployed as part of the NMD system.)

The planned operational X-band radar reportedly will have its 123 m² antenna populated with 81,000 transmit/receive modules and reportedly will have a detection range of about 4,000 km, again against a target with an unspecified radar cross section.²⁹ The X-band radars will thus have an average power of about 170 kW. Reportedly, some of the X-band radars may

initially be deployed with less than the full complement of transmit/receive modules and subsequently upgraded.³⁰ It is unclear if this means that some radars will initially be deployed with less than 81,000 modules and subsequently be brought up to this number, or if radars will subsequently be upgraded to have more than 81,000 modules.

Each X-band radar will have a single face that can be rotated ± 178 degrees in azimuth and 0 to 90 degrees in elevation, but its electronic field of view is limited to 50 degrees in both azimuth and elevation.³¹

The radar will use linear-frequency-modulated waveforms in narrow, medium, and wide bandwidths.³² There appears to be no publicly available data on the bandwidth of the X-band radars. For illustration purposes, we assume the bandwidth will be 10 percent of its operating frequency, or 1 GHz.³³

²⁷ US Ballistic Missile Defense Organization, 1997 Report to Congress, p. 3–9; Kandebo, “NMD System Integrates.”

²⁸ Both the prototype and operational X-band radars have antennas that appear to be “thinned,” that is, the antennas are not fully populated by modules. The antenna of the operational X-band radar appears to have about five times fewer modules than would a fully populated antenna. This thinning allows a larger antenna aperture for a given number of modules, giving a narrower beamwidth, which is desirable in a tracking radar. However, it also decreases the radar’s search capability by about the factor by which it has been thinned (in this case about 5). As discussed above, this loss of search capability may not be an important concern for a radar intended primarily for tracking and discrimination. Note that for a thinned radar, obtaining a power-aperture product simply by multiplying the average power times the physical antenna area will overstate the radar’s search capability.

²⁹ Kandebo, “NMD System Integrates.”

³⁰ Michael C. Sirak, “A C1 to C2 Move Is NMD System’s Most Stressing Upgrade, Says NMD Head,” *Inside Missile Defense*, 3 November 1999, pp. 10–11.

³¹ Kandebo, “NMD System Integrates.”

³² Bassem Mahafza, Stephen Welstead, Dale Champagne, Raj Manadhar, Todd Worthington, and Susan Campbell, “Real-Time Radar Signal Simulation for the Ground Based Radar for National Missile Defense,” in *Proceedings of the IEEE Radar Conference, 1998* (New York: Institute of Electrical and Electronic Engineers, 1998), pp. 62–65.

³³ An extreme upper limit on its bandwidth might be about 2.2 GHz, which is the width of the spectral band assigned to X-band radars by the International Telecommunications Union (ITU) (the precise range is from 8.50 to 10.68 GHz). For example, the ITU lower UHF band for radars is from 420–450 MHz, which corresponds exactly to the range of frequencies used by US early warning radars.

Appendix E

Countermeasures to Ballistic Missile Defenses: Past and Current Programs in the United States, France, and Britain

In this appendix we briefly describe what is publicly known about the past and current US, French, and British programs to develop and deploy countermeasures to ballistic missile defenses.

United States

Although most information about missile defense countermeasures remains classified, it is clear that US work on countermeasures dates back to the early stages of ICBM development.¹ The first US ICBM, the Atlas, flew to intercontinental range for the first time in late 1958, and by that time NASA memoranda indicate that countermeasure work was already under way.²

By early 1964, the United States was reportedly spending \$300–400 million (equivalent to \$1.8–2.4 billion in 1999 dollars) annually in research, development, and production of countermeasures.³ These efforts focused on defeating missile defenses that used nuclear-armed interceptors capable of intercepting warheads both above and inside the atmosphere, rather than the exoatmospheric, hit-to-kill interceptors the planned NMD system will use.

At that time, US countermeasures that were publicly known to be under development or investigation included⁴

- decoys
- chaff
- reduced reentry vehicle (RV) observability
- controlled orientation
- RV maneuvering
- suppression of the RV infrared signature during reentry
- plasma sheath suppression and wake quenching
- active electronic countermeasures
- radar-homing RVs (for attacking defenses)
- hardening of RVs
- nuclear burst jamming
- deployment and salvo tactics
- use of multiple warheads

Countermeasures for ICBMs. In the 1960s, the US Air Force flight-tested reentry vehicles with low radar cross sections and terminal reentry decoy techniques. It was also developing a chaff countermeasure, and the US Army was working on a decoy for its Pershing intermediate-range ballistic missiles. In 1966, it was reported that the Philco-Ford Corporation was investigating two types of replica decoys designed for use outside the atmosphere. One had a wire-grid structure, while the other (known as “Dixie Cup”) was described as being “all metal.” The company was also working on an exoatmospheric jamming decoy.⁵

Countermeasure work was not limited to just research and development: the United States produced decoys for deployment on the Atlas F and Titan 2 ICBMs. A decoy that could be carried on the MIRV

¹ Much of the public information available on countermeasures is for early missile systems that are now retired.

² See for example, James W. Youngblood and Eugene D. Schult, “An Investigation of Possible Decoy Configurations for Intercontinental Ballistic Missiles,” NASA Memorandum 10-4-58L, October 1958.

³ “Penetration Aids: A Space/Aeronautics Staff Report,” *Space/Aeronautics*, February 1964, pp. 47–48.

⁴ Barry Miller, “Studies of Penetration Aids Broadening,” *Aviation Week and Space Technology*, 20 January 1964, pp. 73–93.

⁵ “Filter Center,” *Aviation Week and Space Technology*, 28 November 1966, p. 94.

bus of both the Minuteman ICBM and the Navy's Poseidon SLBM was also developed.⁶

Although little is publicly known about the countermeasures for current US ICBMs, all current US ICBMs are reportedly capable of using countermeasures.⁷

Countermeasures for SLBMs. More specific information is available on the early countermeasure work the US Navy performed for its submarine-launched ballistic missiles (SLBMs), and a review of this history gives at least some idea of the scope of past US countermeasure efforts.⁸ In November 1961, development began of the PX-1 countermeasure system for the Navy's Polaris A-2 SLBM, which carried one large nuclear warhead. Each PX-1 system included six reentry-vehicle decoys, three chaff packages, and two electronic countermeasure packages (jammers). The PX-1 system proceeded into development, with flight testing beginning in July 1962, followed by production. PX-1 systems were deployed on the SLBMs of one submarine, but were removed when the anticipated Soviet missile defenses did not appear.

The follow-on Polaris A-3 missile carried three smaller warheads that were released in a fixed pattern (not independently targeted), giving it a greater capability to overwhelm a defense system. Development of the PX-2 countermeasures system for this missile began in April 1962. Each PX-2 system included six decoys and six chaff packages. Jammers were considered for PX-2 but were ultimately not included. The PX-2 system went into production in May 1965, but shortly thereafter production was suspended until a missile defense threat justifying deployment appeared (a capability to produce PX-2 systems in 18 months was maintained).

The PX-1 and PX-2 countermeasures systems were designed to counter a defense with relatively short-range

interceptors that operated in the upper atmosphere, similar to the US Nike-Zeus system then under development. In fact, the United States was confident that these countermeasures would be effective against this type of defense. According to then-Director of Defense Research and Engineering Harold Brown, "The United States decided...not to deploy the Nike-Zeus because its effectiveness was considered inadequate against US countermeasures programmed for entry into the US inventory before a Nike-Zeus system could be deployed..."⁹

However, when the Soviet Union began deployment of its missile defense system around Moscow, the United States realized that it was considerably different from the US Nike-Zeus defense. The Moscow system including a large long-range interceptor that operated outside the atmosphere (the Galosh interceptor) and a radar with a longer wavelength (which meant that the PX-1 and PX-2 chaff would not work against it¹⁰). Moreover, the Galosh interceptor used a very large nuclear warhead, which the United States believed would enable one interceptor to destroy all three warheads deployed by a Polaris A-3 SLBM.

Thus in 1965, the United States initiated a series of programs, which were eventually combined under the name Antelope, to ensure that Polaris A-3 could defeat defenses of the type under construction at Moscow. A countermeasures carrier was developed that replaced one of the missile's three warheads. This carrier dispensed, using small solid-fuel rockets, countermeasure packages into seven sectors transverse to the missile's velocity vector. Each sector, including the one with the two warheads, contained both decoys and chaff dispensers. In addition, under the Impala program (which was eventually incorporated into Antelope) both large and small endoatmospheric terminal decoys were developed and tested for use on Polaris A-3. Antelope

⁶ Ted Greenwood, "Qualitative Improvements in Offense Strategic Arms: The Case of MIRV," Ph.D. Dissertation, Massachusetts Institute of Technology, August 1973, p. 168.

⁷ Table 4-31 of Chuck Hansen's *Swords of Armageddon*, states that both the Minuteman II and III and MX missiles have countermeasures. Hansen, *Swords of Armageddon*, CD-Rom (Sunnyvale, Calif.: Chukelea Publications, undated) Vol. 7, pp. 490-491.

⁸ The discussion here of the US SLBM program is based on J. P. McManus, *A History of the FBM System*, Lockheed Missiles and Space Company, 1988 and Graham Spinardi, *From Polaris to Trident: The Development of US Fleet Ballistic Missile Technology* (Cambridge, England: Cambridge University Press, 1994).

⁹ Dr. Harold Brown in "Military Aspects and Implications of Nuclear Test Ban Proposals and Related Matters," part 2, Hearings before the Preparedness Investigating Subcommittee, Committee on Armed Services, US Senate, 89th Congress, first session, 1965, p. 860. (Cited in Ted Greenwood, Ph.D. Dissertation, p. 153.)

¹⁰ To be effective against a radar, chaff strands should be cut to a length equal to half the radar wavelength. Thus, the PX-1 and PX-2 chaff, which was designed against a radar with a different wavelength, was not cut to the correct length for the Moscow radar. Although in principle the use of longer chaff should have been straightforward, it would have required a redesign and new tooling, since both the PX-1 and PX-2 systems had already been in production.

also included programs to harden both the Polaris missile and its warheads against nuclear effects. Ultimately, however, none of the countermeasures developed under Antelope were deployed (although the missiles were hardened against radiation), in part because it became apparent that the Moscow ABM system would remain limited in scale (and the task of defeating it was assigned to the Minuteman ICBMs and their countermeasures) and because the US Navy decided to emphasize the development of its next SLBM, the Poseidon.

The Poseidon SLBM, first deployed in 1971, was capable of carrying up to 14 independently targeted reentry vehicles, and was thus considered inherently resistant to missile defenses such as that deployed around Moscow. Moreover, with the 1972 signing of the ABM Treaty (and its 1974 protocol), the Soviet Union was limited to deploying only 100 interceptors around Moscow. Various countermeasure concepts were studied for Poseidon, including one that would have replaced a reentry vehicle with a module containing either seven decoys or twelve “clutter clumps.” With the limited nature of the Soviet ABM threat, it appears that none of these was actually deployed.

A countermeasure system was also developed for the successor to Poseidon, the Trident I SLBM. This system was built around a maneuvering reentry vehicle, the Mk-500 (known as the Evader). The system also involved the use of chaff and decoys. After a development program that included a number of test flights in the mid-1970s, the program was put into maintenance status, which provided the ability to deploy within three years of a decision to do so. Although work on countermeasures for the follow-on Trident II SLBM is known to have taken place, little information is available about these programs.

France¹¹

France has deployed two types of long-range ballistic missiles: land-based intermediate-range ballistic missiles (IRBMs), which have now been retired, and SLBMs, which are now the only ballistic missiles France deploys.

France began deployment of its second-generation IRBM, the single-warhead S-3 missile, in 1980. These missiles were reportedly deployed with a system of countermeasures, including decoys.

The third-generation French SLBM, the single-warhead M-20, which entered service in 1977 and was retired in 1991, was deployed with a system of countermeasures, including decoys, specifically designed to penetrate the ABM system around Moscow. Its replacement, the M-4 series of SLBMs (including the most recent M-45) added considerable anti-defense capability by introducing MIRVs, with each missile carrying up to six warheads. These SLBMs reportedly also include new countermeasures and warheads that emphasize nuclear hardening and reduced radar cross sections. The planned replacement for the M-4 SLBMs, the M-5, which is expected to be deployed in the 2010–2015 timeframe, will reportedly employ a variety of countermeasures, including decoys.¹²

Britain

With the exception of 60 Thor intermediate-range missiles provided by the United States and deployed in Britain under a dual-key arrangement from 1958 to 1963, Britain’s long-range missile force has been composed only of SLBMs. No information is publicly available about countermeasures on Britain’s current Trident-II SLBMs. However, the Polaris SLBMs they replaced beginning in 1995 deployed a complex countermeasures system known as Chevaline.¹³

Chevaline began development in 1973 and deployment in 1982. The system was complex because Britain designed Chevaline to defeat the Soviet missile defense deployed around Moscow, which used nuclear-tipped interceptors, and because Britain assumed correctly that the Soviet defense would deploy both endoatmospheric and exoatmospheric interceptors.

In place of one of the three Polaris warheads, Chevaline employed a countermeasure that used a maneuvering bus. It was described by the British Ministry of Defence as “a sophisticated space craft, which after separation from the second stage of the missile, maneuvers itself in space so its payload can be correctly deployed,” the “payload of which consists of a large number of countermeasures designed to confuse the Anti-Ballistic Missile radars.”¹⁴

In addition to the two real warheads, Chevaline deployed four decoy warheads that were lighter than

¹¹ The information in this section is from Robert S. Norris, Andrew S. Burrows, and Richard W. Fieldhouse, *Nuclear Weapons Databook, Volume 5: British, French, and Chinese Nuclear Weapons* (Boulder, Colo.: Westview Press, 1994).

¹² Norris, et al., *Nuclear Weapons Databook*, Vol. 5, p. 260, and “Nuclear Notebook: French and British Nuclear Forces, 1999,” *Bulletin of the Atomic Scientists*, July/August 1999, p. 77–79.

¹³ The information about Chevaline is from Norris, et al., *Nuclear Weapons Databook*, Vol. 5, pp. 105–113.

¹⁴ Norris, et al., *Nuclear Weapons Databook*, Vol. 5, p. 112.

the real warheads. According to some sources, all six objects used anti-simulation—they were enclosed in gas-filled metal-coated balloons to make all the warheads look like decoys. Chevaline also released a large number of other balloon decoys with nothing inside.¹⁵ Outside the atmosphere, all the balloons—empty or not—would behave the same and the large number of balloons would overwhelm the exoatmospheric interceptors.

To defeat any endoatmospheric interceptors, Chevaline employed several additional measures. First, the reentry vehicles reportedly conducted preplanned maneuvers on reentry. The four decoy warheads were also fitted with small liquid-fueled rocket motors to allow them to compensate for the fact that atmospheric drag would have different effects on reentering objects of different weights. The British submarines carried 16 SLBMs, and Chevaline was also designed to permit all the real and decoy warheads fired from one submarine to arrive over the target simultaneously.

Britain apparently encountered technical difficulties in developing the Chevaline countermeasure package, and this fact has been used to argue that building countermeasures is inherently difficult.¹⁶ However, this argument is specious for two reasons. First, because Chevaline was designed to defeat Russian nuclear-

armed exoatmospheric and endoatmospheric interceptors it was very complex. It is much more difficult to design countermeasures against these types of interceptors than against the hit-to-kill exoatmospheric interceptors the planned US NMD system would use. Second, most of Britain's difficulties apparently centered on developing the maneuvering bus, which was the most technically complex component of the system (and which Britain eventually hired US contractors to build). The maneuvering bus was designed to release the various warheads and decoys with enough precision so that all the objects released by all the SLBMs that were fired from one submarine would arrive on different trajectories over the target area at the same time. Britain had little experience developing such buses because it did not develop its own SLBMs, but rather purchased them from the United States. According to the British Ministry of Defense, the Chevaline system required "pushing the state of the art beyond limits already explored in the UK."¹⁷ The package of exoatmospheric countermeasures was apparently similar to that developed by the United States for the Antelope system in the mid-1960s. There is no indication that these countermeasures, which are the type relevant to the current NMD system, were problematic for Britain to develop.

¹⁵Norris, et al., *Nuclear Weapons Databook*, Vol. 5, p. 112 and John Barry, personal communication, December 1999.

¹⁶ Stanley Orman, "Defeat of Missile Defenses Not as Simple as Portrayed," *Defense News*, 13 September 1999, p. 15.

¹⁷Norris, et al., *Nuclear Weapons Databook*, Vol. 5, p. 111.

Appendix F

The Reentry Heating of Submunitions

In this study we consider two configurations of bomblets. The first is a sphere with a total mass of 10 kilograms and a diameter of 20 centimeters. The second is a conical bomblet with a length of 20 centimeters, and also with a mass of about 10 kilograms. We show that heatshield requirements for both of these bomblets on intercontinental-range trajectories can easily be met using materials that were developed over 30 years ago.

We assume the bomblets follow a 10,000 kilometer-range minimum-energy trajectory, and have a speed of 7 km/s and a reentry angle of 24 degrees (with respect to the local horizontal) at an altitude of 150 kilometers as they begin to reenter the atmosphere.¹

We calculate the trajectory of the bomblet by integrating the equations of motion under the influence of gravity and atmospheric drag.² The key parameter governing the behavior of the bomblets as they reenter through the atmosphere is their ballistic coefficient (β), which is given by

$$\beta = W/C_D A \quad (\text{F-1})$$

where W is the weight of the bomblet, A is the cross-sectional area perpendicular to the direction of motion, and C_D is its drag coefficient. The higher the value of β , the less the object is slowed by air resistance and the faster it falls through the atmosphere. Early reentry bodies were made to have small ballistic coefficients so that they would slow down relatively high in the atmosphere where a smaller fraction of the heat generated during reentry is transferred to the body. As heatshields

improved and could withstand higher heating rates, the United States and the Soviet Union increased β by shaping the ballistic missile reentry vehicles as narrow cones. Faster reentry increases the accuracy of a reentry vehicle since it spends less time in the atmosphere being subjected to winds and other forces. Modern warheads have values of β in the range of 100,000–150,000 N/m² (2,000–3,000 lb/ft²).

The trajectory is then used to calculate the heat transferred to the bomblet by using empirically derived equations for the heat transfer to bodies in hypersonic flow.³ These equations give the heat absorbed per area per unit time for the stagnation point (the point at the front of the reentry vehicle, where the air flow is brought to rest), for laminar boundary layer flow across a flat plate, and for turbulent flow across a flat plate.

Stagnation point:

$$\left(\frac{dq}{dt}\right)_{SP} = \frac{1.83 \times 10^{-4}}{\sqrt{R}} \left(1 - \frac{h_w}{h_0}\right) \rho^{0.5} V^3 \quad (\text{F-2})$$

Laminar flow:

$$\left(\frac{dq}{dt}\right)_L = 2.53 \times 10^{-5} \frac{(\cos \phi)^{0.5} \sin \phi}{x^{0.5}} \left(1 - \frac{h_w}{h_0}\right) \rho^{0.5} V^{3.2} \quad (\text{F-3})$$

Turbulent flow (for $V \leq 4$ km/s):

$$\left(\frac{dq}{dt}\right)_{T<} = 3.89 \times 10^{-4} \frac{(\cos \phi)^{1.78} (\sin \phi)^{1.6}}{x^{0.2}} \times \left(1 - 1.11 \frac{h_w}{h_0}\right) \left(\frac{556}{T_w}\right)^{0.25} \rho^{0.8} V^{3.37} \quad (\text{F-4})$$

¹ We begin our heating calculation at 150 km altitude since heating is negligible at (and above) this altitude.

² The program that calculates the trajectory is described in Lisbeth Gronlund and David Wright "Depressed Trajectory SLBMs," *Science and Global Security*, Vol. 3 (1992), pp. 101–159.

³ John Anderson, *Hypersonic and High Temperature Gas Dynamics* (New York: McGraw-Hill, 1989), p. 291.

Turbulent flow (for $V > 4$ km/s):

$$\left(\frac{dq}{dt}\right)_{T>} = 2.2 \times 10^{-5} \frac{(\cos \phi)^{2.08} (\sin \phi)^{1.6}}{x^{0.2}} \times \left(1 - 1.11 \frac{h_w}{h_0}\right) \rho^{0.8} V^{3.7} \quad (\text{F-5})$$

Here dq/dt is the heat flux (in $\text{J/m}^2\text{s}$), ρ is the atmospheric density (in kg/m^3), V is the speed of the body relative to the air (in m/s), x is the distance along the surface of the body measured from the nose (in m), ϕ is the angle between the surface of the body and the freestream airflow, R is the radius of the nose (in m), T_w is the wall temperature (in K), h_0 is the stagnation enthalpy per unit mass (in J/kg), and h_w is the surface or “wall” enthalpy per unit mass.

Notice that the stagnation heating rate varies inversely with the square root of the radius of curvature of the nosetip.

The factor in these equations containing the ratio of the wall enthalpy and the stagnation enthalpy can be interpreted as modifying the equations to give the “hot-wall heating rate,” that is, it takes into account the fact that the heat transfer to the body depends on the temperature difference between the surface of the body and the surrounding air.⁴ We set this factor equal to zero when it becomes negative, thus ignoring radiation of heat by the body to the air surrounding it.

The stagnation enthalpy is given by

$$h_0 = \frac{V^2}{2} + h_\infty \quad (\text{F-6})$$

where h_∞ is approximately 2.3×10^5 J/kg for all altitudes of interest here.⁵ The wall enthalpy h_w is taken to be the enthalpy of air evaluated at the wall temperature, and is given approximately by

$$h_w = 1000T_w \quad (\text{F-7})$$

(in J/kg) where T_w is taken as the ablation temperature (in Kelvin).⁶

⁴ C.J. Katiskas, G.K. Castle, and J.S. Higgins, *Ablation Handbook*, AVCO Corporation Technical Report AFML-TR-66-262, September 1966, p. 58.

⁵ John J. Martin, *Atmospheric Reentry* (Englewood Cliffs, New Jersey: Prentice-Hall, 1966), p. 16; Katiskas, *Ablation Handbook*, p. 242.

⁶ Martin, *Atmospheric Reentry*, p. 114; Katiskas, *Ablation Handbook*, p. 84.

Initially, when a reentering body is at high altitudes, the boundary layer flow of air around the body will be laminar. At lower altitudes, the flow will eventually become turbulent. One commonly hears that the transition from laminar to turbulent boundary layer flow occurs at a Reynolds number of about 5×10^5 . This number is for incompressible flow over a flat plate and assumes lower speeds than those considered here early in the reentry phase. Hypersonic speeds tend to stabilize the flow and the transition can occur at Reynolds numbers several orders of magnitude higher. On the other hand, nose bluntness, surface roughness, and material injected into the boundary layer can lower the transition number.⁷ The altitude at which this transition occurs is important since considerably more heat is transferred through a turbulent layer than a laminar layer. For modern reentry vehicles, a typical value for the transition altitude appears to be 20–30 kilometers.⁸ We discuss below what assumptions we make about this transition in calculating the heating of the two bomblets.

Heatshield Calculations

Once the heating rate on reentry is known and a heatshield material has been chosen, we can estimate two quantities: the thickness of material ablated from the surface of the heatshield and the amount of insulation required to keep the temperature of the inside surface of the heatshield (the “backface temperature”) below some specified level.

The physical processes that take place at the surface of an ablating heatshield are complex and analyzing them in detail is beyond the scope of this study.⁹ Therefore, to estimate the amount of heatshield material ablated, we use an approximate technique that involves an “effective heat of ablation,” q^* (in J/kg), which has been empirically determined for a number of materials, and describes the heatshield material’s ability to block heat from entering the body.¹⁰ This

⁷ Anderson, *Hypersonic and High Temperature Gas Dynamics*, p. 274.

⁸ Gronlund and Wright, “Depressed Trajectory SLBMs,” p. 148.

⁹ See, for example, Michael Ladacki, “Chemical Aspects of Ablation,” in R. Landel and A. Rembaum, ed., *Chemistry in Space* (New York: American Elsevier, 1972), pp. 253–318.

¹⁰ Ladacki, “Chemical Aspects,” 260–262; Martin, *Atmospheric Reentry*, pp. 106–114; Katiskas, *Ablation Handbook*, pp. 80, 107–108; H. Hurwicz, “Aerothermochemistry Studies in Ablation,” in R.P. Hagerty et al., ed., *Combustion and Propulsion*, 5th Agard Colloquium on High-Temperature Phenomena, Braunschweig, Germany, 9–13 April 1962

approximate method is reported typically to estimate the amount of material ablated to within 10 percent or less of the results of a more rigorous analysis that explicitly includes charring of the heatshield material and other physical processes.

For our calculations, we use the thermochemical heat of ablation, defined as¹¹

$$q^* = \frac{dq/dt - (dq/dt)_{rad}}{\rho_{hs}(ds/dt)} \quad (\text{F-8})$$

where dq/dt is given by equations (F-2) through (F-5), $(dq/dt)_{rad}$ is the heat flux radiated from the body, ρ_{hs} is the density of the heatshield material, and ds/dt is the recession rate of the heatshield surface. The denominator is simply the rate of ablation of mass per area from the heatshield. This quantity can also be defined as

$$q^* = C_p(T_w - T_0) + H_V + \eta(h_0 - h_w) \quad (\text{F-9})$$

where the first term is the heat absorbed by the heatshield in raising the temperature to the ablation temperature, the second term is the heat of vaporization of the heatshield material, and the final term is the heat that is blocked from being absorbed by the body. Here C_p is the specific heat of the heatshield, T_0 and T_w are the initial and ablation temperature of the heatshield, and η is called the blowing or transpiration coefficient. This last contribution arises because the emission of ablation products into the boundary layer is found to reduce the amount of heat absorbed by the body compared with what one would expect in the absence of these emissions.¹²

Using equation (F-8), the effective heat of ablation can then be used to calculate the rate of mass loss per area due to a heat flux of dq/dt at the surface:

$$\frac{dm}{dt} = \frac{dq/dt}{q^*} \quad (\text{F-10})$$

where dm/dt is given in units of $\text{kg}/\text{m}^2\text{s}$. Here we have neglected the radiation term in equation (F-8), which

(New York: MacMillan, 1963), pp. 403–452; L.M. Herold and E.S. Diamant, "Thermal Performance of Cork Insulation on Minuteman Missiles," *J. Spacecraft*, Vol. 3, May 1966, pp. 679–684.

¹¹ Ladacki, "Chemical Aspects," p. 262; Katiskas, *Ablation Handbook*, p. 80, 107.

¹² Ladacki, "Chemical Aspects," pp. 258–262; Hurwicz, "Aerothermochemistry," pp. 431–432; Katiskas, *Ablation Handbook*, pp. 68–69.

is only a few percent of the other heating term for the conditions we are considering. Neglecting reradiated heat will overestimate the amount of material that is ablated.

The total mass δm ablated per area is then found by integrating dm/dt over the trajectory, and the total thickness of material ablated is found by dividing δm by the density of the heatshield material.

The insulation requirements are determined using a heat-conduction program that was written for this purpose.¹³ This program takes as input the surface heating rate as a function of time during reentry, which is calculated from equations (F-2) to (F-5) on the trajectory of the bomblet. The program then calculates the temperature increase of the heatshield surface and the conduction of heat into the heatshield by numerically integrating standard heat conduction equations. (The program assumes spherical symmetry, so that the problem reduces to one dimension.) When the surface temperature becomes sufficiently high, the program calculates the ablation of material at the surface using an effective heat of ablation.¹⁴ Since we are only interested in approximate results, the program uses average values of the heatshield material properties over the temperature range of interest, although it could be modified to use material properties as a function of temperature if desired.

Analysis for the Spherical Bomblet. The spherical bomblet is taken to be a sphere with a radius of 10 centimeters and a mass of 10 kilograms. Using experimental data for the drag coefficients of spheres,¹⁵ one finds that the drag coefficient C_D has a value of roughly 0.5 for speeds less than Mach 1 (0.3 km/sec) and roughly 0.9 for speeds greater than Mach 1.

Thus, the bomblets will have $\beta = 3400 \text{ N}/\text{m}^2$ ($70 \text{ lb}/\text{ft}^2$) for high speeds (as they reenter the

¹³ This program was written by Dr. Jeremy Broughton in June 1999.

¹⁴ The program calculates the mass of ablated material slightly differently than the method described above since it only considers ablation to occur when the surface temperature is above an effective ablation temperature, whereas in the method described above the mass ablation rate is calculated over the entire trajectory. Since in this part of the calculation we are only interested in calculating the heat conduction in the body and not the ablated mass, we therefore choose the value of the effective heat of ablation used in the program to give the same amount of ablated material as the method above.

¹⁵ Sighard, F. Hoerner, *Fluid Dynamic Drag* (Albuquerque: Hoerner Fluid Dynamics, 1965), p. 16.

atmosphere) and $\beta = 6200 \text{ N/m}^2$ (130 lb/ft²) for speeds less than Mach 1. For the bomblet and trajectory considered here, this transition occurs when the bomblet reaches an altitude of roughly 12 kilometers (see Figure F-1).

We assume that the bomblet is spinning on reentry, which causes the heat transferred to the body to be averaged over the bomblet's surface. This averaging reduces the heat loading on any particular part of the heatshield, and simplifies the calculation by making the problem spherically symmetric. One could cause the bomblet to spin by putting sets of asymmetric ridges on the surface of the heatshield to create a torque in the upper atmosphere. These ridges would burn off at lower altitudes, but not until they had already done their job.

With this assumption, we calculate an average local heating rate at a given time by integrating the heating rate over the surface of the sphere and dividing by the surface area. We use the heating equations (F-2) through (F-5) to calculate the heating along the trajectory in two parts: (1) we assume the heating rate is given by the stagnation point formula over an area on the front of the sphere that reaches from θ equals zero to 20 degrees from the velocity vector, and (2) we apply the flat-plate equations to rings of width $r \times d\theta$ (where r is the sphere radius) and having constant angle with respect to the bomblet velocity, and then integrate the heating over such rings from θ equals 20 to 90 degrees (see Figure F-2). We assume the boundary-layer flow separates from the body and the heating is zero over the rear hemisphere (for θ between 90 and 180 degrees).

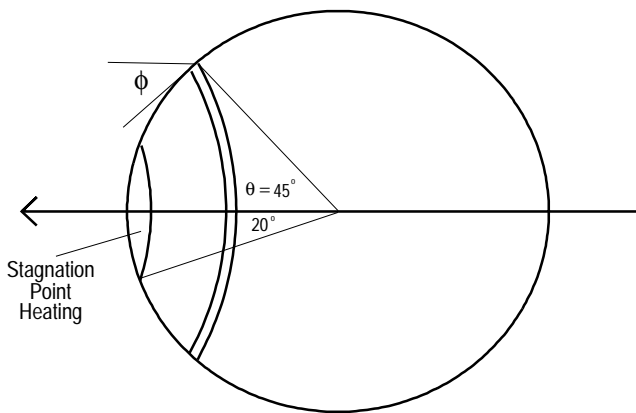

Figure F-2. This figure shows how the heating equations are applied to the sphere in this analysis. The arrow indicates the direction of the bomblet's velocity. The stagnation point heating value is applied over a region out to $\theta = 20$ degrees from the velocity. The flat-plate equations are applied to rings around the velocity vector, each having a surface with a constant angle $\phi = 90 - \theta$ with respect to the velocity.

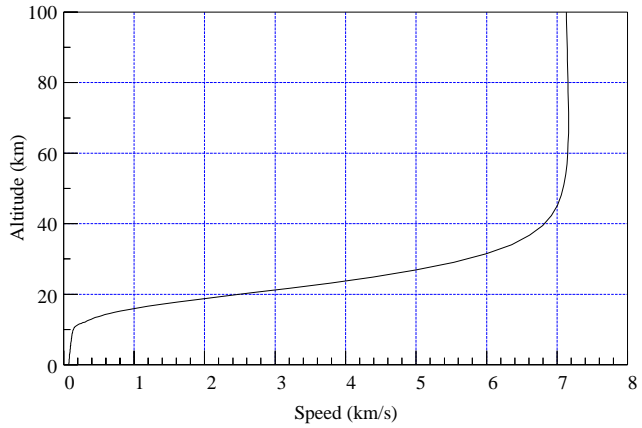

Figure F-1. Speed as a function of altitude for the spherical bomblet on the reentry trajectory described in the text.

To be conservative in our analysis, we calculate the heating of the bomblet using the turbulent boundary layer equations for all altitudes. This assumption leads to an overestimate of the heat transfer to the bomblet.

Figure F-3 shows the local heating rates at the stagnation point and at a point 45 degrees around the sphere from the stagnation point, as well as the heating rate averaged over the surface; the latter is used as input to the heat conduction program. (These curves, and those in Figures F-5 and F-6 below, are calculated assuming a wall temperature of 2,700 K, which is appropriate for silica phenolic, as discussed below.)

We calculate that the total heat transferred to the bomblet is roughly 8×10^6 J. This figure is about

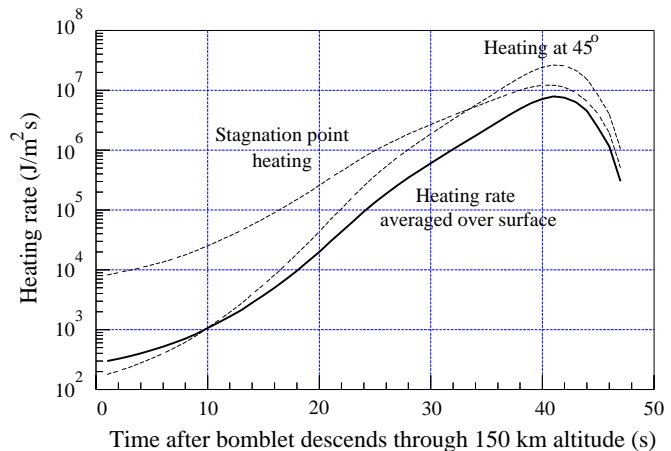

Figure F-3. The dashed curves show the local heating rate for the spherical bomblet calculated at the stagnation point and at a point 45 degrees around the sphere from the velocity vector. The solid curve shows the heating rate averaged over the surface of the sphere, where the bomblet is assumed to be spinning. The origin of time is taken when the bomblet is at 150 kilometers altitude.

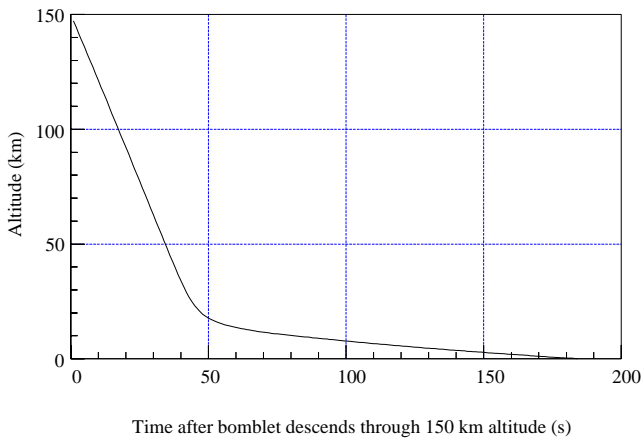

Figure F-4. Altitude as a function of time for the spherical bomblet.

3 percent of the total kinetic energy of the bomblet at the start of reentry.

The low ballistic coefficient of this bomblet causes it to slow rapidly during reentry. The peak deceleration takes place at 25 kilometers altitude, and the bomblet has a speed of 75 meters per second at ground level (see Figures F-1 and F-4). The time to reach the ground from 150 kilometers altitude is 185 seconds.

By comparison, the Mark 21 reentry vehicle developed by the United States for the Peacekeeper (MX) missile has a ballistic coefficient of about 144,000 N/m² (3000 lb/ft²).¹⁶ On a trajectory having the same reentry speed and angle at 150 kilometers altitude as the bomblet considered here, it would reach the ground in 54 seconds and would impact at 3.4 km/s. Peak deceleration would occur at 6 kilometers altitude—less than 4 seconds before impact. Thus while Figures F-5

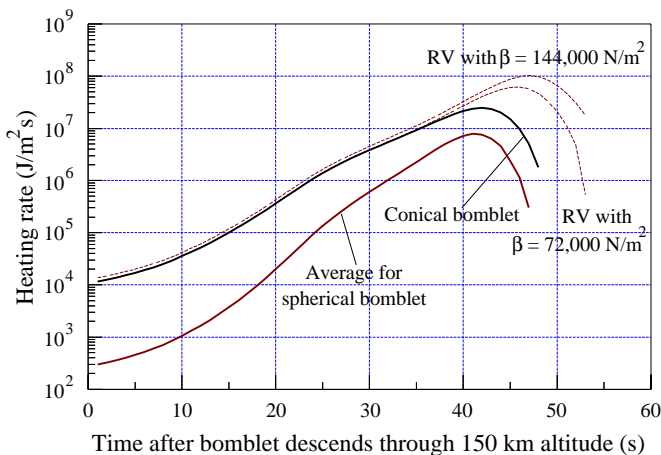

Figure F-5. The average heating rates of the spherical bomblet compared with the stagnation point heating rate of the conical bomblet and two reentry vehicles having much higher ballistic coefficients: $\beta = 144,000 \text{ N/m}^2$ (3,000 lb/ft²) and $\beta = 72,000 \text{ N/m}^2$ (1,500 lb/ft²).

and F-6 show that the peak heating rate of the spherical bomblet is 5 to 10 times lower than that of the Mark 21 reentry vehicle, the longer flight time for the bomblet means that the absorbed heat has a much longer time to diffuse toward the interior of the body.¹⁷

These figures also show the heating rate of a reentry vehicle with a ballistic coefficient of 72,000 N/m² (1500 lb/ft²). This reentry vehicle is assumed to have a nose radius of 5 centimeters and a cone half-angle of 15 degrees, and the transition to turbulent boundary layer flow is assumed to occur at 50 kilometers altitude. This reentry vehicle would reach the ground from 150 km altitude in 58 seconds. Peak deceleration occurs at 10 kilometers altitude, 8 to 9 seconds before impact.

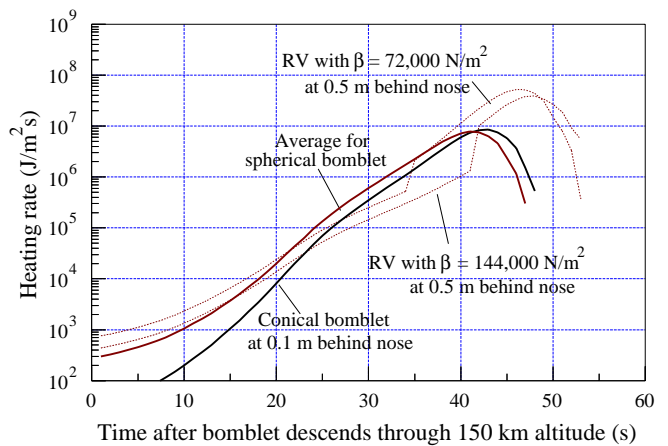

Figure F-6. The surface-averaged heating rate of the spherical bomblet compared with the heating rates on the walls of the conical bomblet (at a point 0.1 m behind the nose) and the two reentry vehicles described in Figure F-5 (at a point 0.5 m behind the nose). The jumps in the dashed curves are caused by the transition from laminar to turbulent boundary-layer flow.

Now that we have calculated the heating rate as a function of time for the trajectory of interest, we can analyze the performance of a heatshield made of a particular material.¹⁸ The first we consider is silica

¹⁶ Chuck Hansen, *US Nuclear Weapons: The Secret History* (Arlington, Tex.: Aerofax, 1988), p. 202. Ballistic coefficients can be calculated from the shape of the reentry vehicle using equations in Frank J. Regan, *Re-Entry Vehicle Dynamics* (New York: American Institute of Aeronautics and Astronautics, 1984), p. 230.

¹⁷ The Mark 21 heating curves assume the transition to turbulent boundary-layer flow occurs at 30 kilometers altitude.

¹⁸ There is considerable information on material properties available in the open literature. See, for example, S.D. Williams and Donald M. Curry, "Thermal Protection

phenolic, also called reffrasil phenolic, which is a composite that uses high-purity silica fibers in a cloth that is impregnated with phenolic resin. This material was developed during the 1960s. The values for the material properties we use in our analysis for reffrasil phenolic are a density of $1,632 \text{ kg/m}^3$, a specific heat of $1,174 \text{ J/kg-K}$, and a thermal conductivity of 0.5 J/m-s-K . We use an ablation temperature of $2,700 \text{ K}$ and a wall enthalpy of $3.3 \times 10^6 \text{ J/kg}$.¹⁹

We estimate the mass ablated from the surface of the bomblet using the effective heat of ablation, which is shown in Figure F-7 for this material. For the heating rate calculated on the trajectory discussed above, we calculate a total ablated mass of 0.6 kg , or an average depth of ablation of less than 3 millimeters over the surface of the sphere.

We also calculate temperature profiles within the heatshield using the program described above, which numerically integrates the heat conduction equations for the bomblet. The bomblet is assumed to have an initial, uniform temperature of 300 K .²⁰ The reentry heating of the bomblet's surface raises the surface temperature and the heat begins to diffuse inward. When the temperature of the outer surface reaches the ablation temperature, the temperature stops increasing and the heatshield begins to ablate. The program calculates temperature profiles within the heatshield at five times during reentry, with the final one being the time at which the bomblet hits the ground.

Figure F-8 shows the temperature profile at 37 seconds ($t = 0$ is taken to be when the bomblet is at 150 kilometers altitude). The surface is at the ablation temperature and the ablation has caused the outer radius of the bomblet to recede slightly from the original surface at a radius of 10 centimeters. Subsequent profiles are shown in Figure F-9. By 74 seconds, ablation

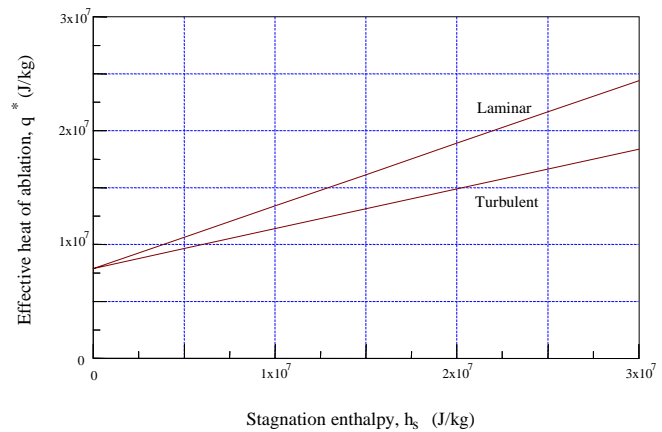

Figure F-7. Value of the effective heat of ablation used in the calculations for reffrasil phenolic heatshield material. (Katiskas, "Ablation Handbook," p. 81; Hurwicz, *Aerothermochemistry*. pp. 431–433.)

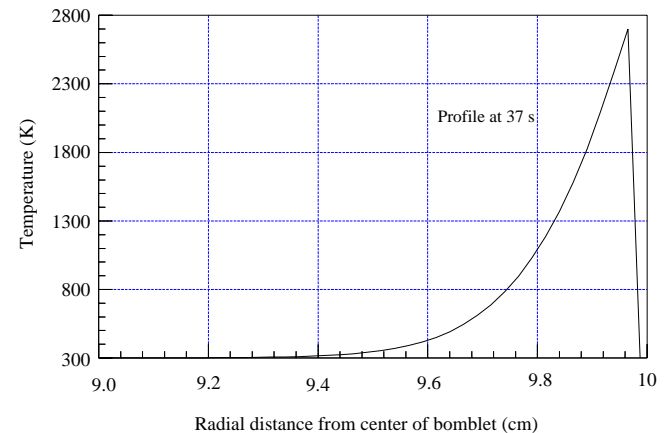

Figure F-8. Temperature profile in the outer centimeter of heatshield for the spherical bomblet when it is 37 seconds below 150 km altitude.

The original surface of the heatshield is at the right side of the graph. Ablation of material has caused the surface to recede slightly from the original surface at 10 cm. At this time, the surface is at the ablation temperature of 2700 K . (The surface does not appear as a vertical line because of the finite step size used in the calculation.) The heatshield material is reffrasil phenolic.

has stopped after the surface has receded about 3 millimeters. The temperature profile at 185 seconds, when the bomblet hits the ground, shows that the temperature would rise only to 350 K at the inner surface of a 2-centimeter-thick heatshield, or to less than 320 K at the inner surface of a 2.5-centimeter heatshield.²¹

Materials: Thermophysical Property Data," NASA Reference Publication #1289, 1992; S.C. Gonzales, "Aerodynamic Heating on a Blunt-Cone Reentry Vehicle," Sandia National Laboratories Report SAND80-2794C, 1 January 1981; C.D. Pears and E.D. Smyly, "Properties of Ablation and Insulation Materials, Volumes 1, 2, 3," NASA-CR-111917, 1 June 1971.

¹⁹ Katiskas, *Ablation Handbook*, p. 251. Some sources give an ablation temperature of $2,500 \text{ K}$. Using this temperature in the calculations increases the mass ablated by less than 3 percent.

²⁰ The temperature of the bomblet could increase or decrease during flight, depending on a number of factors (see Appendix A). Since the heat required to bring the outer layer of the heatshield to the ablation temperature is small compared to the heat dissipated by ablation, this assumption will not affect our results.

²¹ The curves in Figure F-9 were calculated for a heatshield thickness of 4 centimeters. The temperatures noted for the 2- and 2.5-centimeter-thick heatshield ignore the small amount of heat that flows into the interior parts of the heatshield. This approximation only changes the calculated

A shell of this material with an outer radius of 10 centimeters and a thickness of 2 to 2.5 centimeters would have a mass of 3.3 to 4.0 kilograms. In practice, to optimize the design and reduce mass, a thinner shell of ablating material would be used, backed with an insulating layer made of low-density material with low thermal conductivity. In addition, if the bomblet had a metallic shell for structure inside the heatshield, the metal would act as a heat sink and could reduce the amount of heatshield required.

There are also other standard heatshield materials that can be considered. For example, to reduce the mass of the shell, low-density nylon phenolic might be used, since a 2-centimeter-thick shell of this material with an outer radius of 10 centimeters would have a mass of only 1.2 kilograms. Using this material would result in a greater volume of material being ablated than for silica phenolic (the surface recession is about 9 millimeters). However, temperature profiles calculated for nylon phenolic show that at 185 seconds, the inner surface of a heatshield with an original thickness of 2 centimeters would only increase by about 20 K.

Analysis for the Conical Bomblet. Another option that we consider is the conical bomblet. The conical shape will result in a higher ballistic coefficient, which will reduce the reentry time and thus the time for heat to diffuse into the bomblet. In addition, this shape can be designed to fall nose first. A contact fuse can then set off an explosive charge that disperses the agent upward out the back of the bomblet.

To calculate the heating and the behavior of the heatshield, we consider the model shown in Figure 7-2 of Chapter 7 and again assume a total mass of 10 kilograms. There is nothing special about this specific configuration—the size and shape could be varied if desired, e.g., to ensure aerodynamic stability during reentry. What we show here is that the heatshield requirements for this type of body can easily be met with simple materials and with a size and mass consistent with the assumed size and mass of the bomblet.

From its shape, one can estimate a ballistic coefficient for this bomblet of about $12,000 \text{ N/m}^2$ (250 lb/ft^2),²² which we assume is constant throughout reentry.

For this case we calculate the heating rate at two points on the body: at the nosetip (using the stagnation

temperature increases by a few percent, which is within the accuracy of the calculation.

²² Regan, *Reentry Vehicle Dynamics*, p. 230.

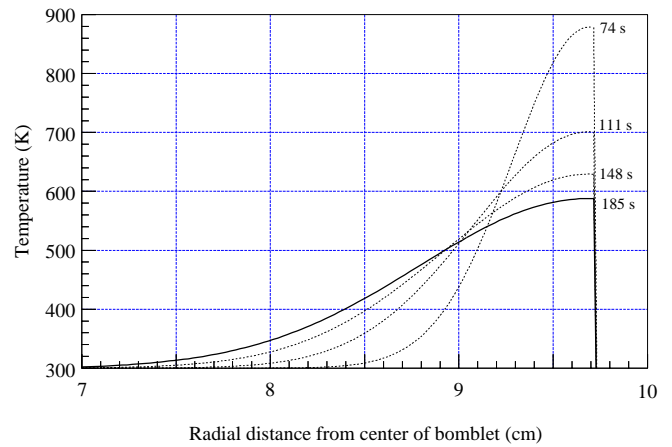

Figure F-9. Evolution of the temperature profile in the heatshield of the spherical bomblet at times later than Figure F-8.

By 74 seconds, the heating rate has decreased due to the slowing of the bomblet and the surface is no longer ablating. Roughly 3 mm of material has ablated from the surface. The solid curve at 185 seconds shows the temperature profile at the time the bomblet would hit the ground. The heatshield material is refracil phenolic.

point heating equation (F-2) above), and at a point on the wall 10 centimeters back from the nose. Again, to be conservative in our heating estimates, we use the turbulent heating equations at all altitudes, since these give more severe heating than the laminar equation.

The peak deceleration of this bomblet occurs at 20 kilometers altitude, and the bomblet would have a speed of 150 meters per second at ground level (see Figures F-10 and F-11). The time to reach the ground from 150 kilometers altitude is 115 seconds.

Figure F-12 shows the heating rates during reentry at the two points we consider. We again consider a heat-

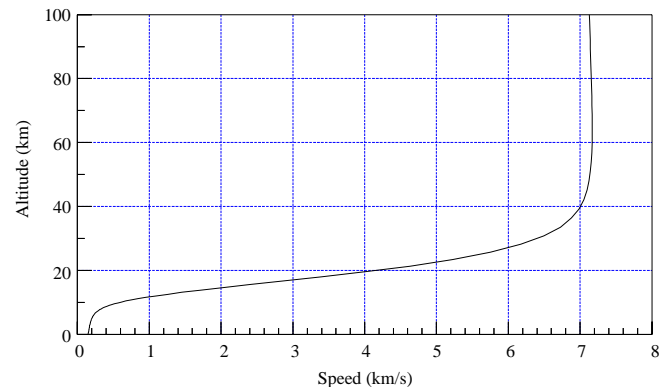

Figure F-10. Speed as a function of altitude for the conical bomblet on the trajectory described in the text.

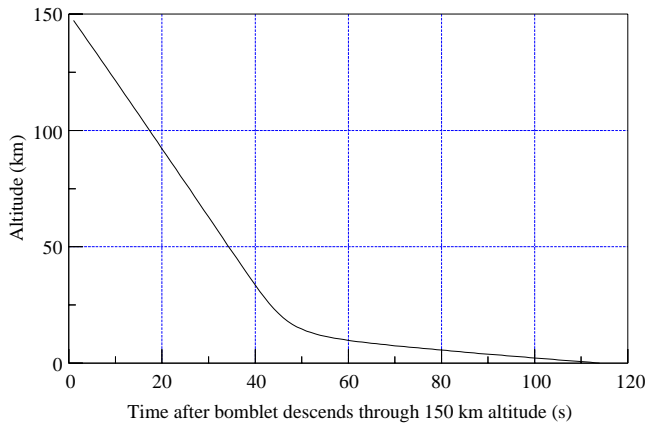

Figure F-11. Altitude as a function of time for the conical bomblet.

shield made of reffrasil phenolic. We find that the heatshield is ablated a distance of 1.1 centimeters at the nosetip and about 3 millimeters at the location being considered on the wall.

Figure F-13 shows the temperature profile in the heatshield at the nosetip of the cone when it reaches the ground. Recall that the nose is assumed to have a 5-centimeter radius of curvature. These figures show that an original thickness of 2.5 centimeters of heatshield at the nose would keep the backface temperature at less than 330 K at impact.

Figure F-14 shows the temperature profile in the heatshield at impact at the point on the wall 10 cm back

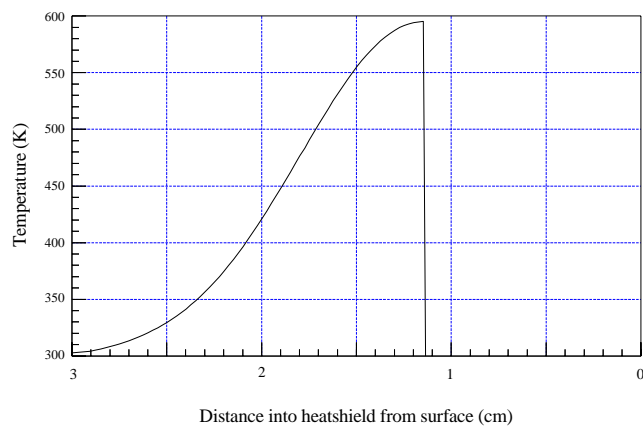

Figure F-13. Temperature profile in the heatshield at the nose of the conical bomblet when the bomblet hits the ground.

The original surface of the heatshield is at the right side of the graph and the x-axis gives the distance into the heatshield. The figure shows that 1.1 cm of heatshield have ablated from the nose at the stagnation point. The surface temperature is about 600 K but drops to less than 305K at a distance 3 cm in from the original heatshield surface. The heatshield material is reffrasil phenolic.

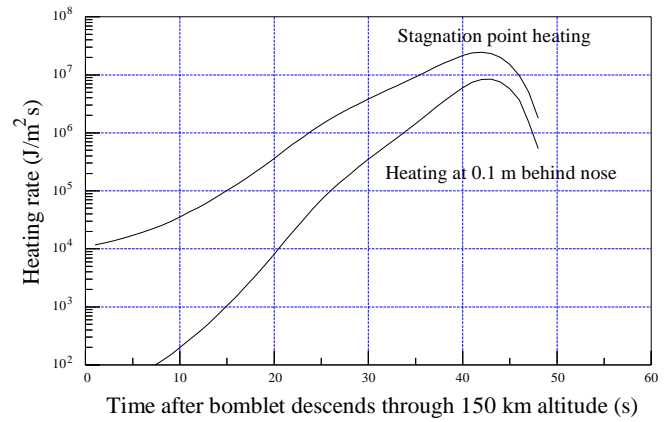

Figure F-12. Local heating rates for the conical bomblet at the stagnation point and at a point on the wall 10 cm behind the nose.

(See also Figures F-5 and F-6, which compare these curves to those of two reentry vehicles with high ballistic coefficients).

from the nose. These figures show that at impact a 2-centimeter-thick heatshield would give only about a 10 K temperature rise at the inner surface of the heatshield, and a 1.5-centimeter-thick heatshield would give about a 60 K rise.

If one considers a 5-centimeter-radius hemisphere of heatshield material at the nose, and 2 centimeters of material on the side walls, the total mass of this heatshield would be about 2 kilograms.

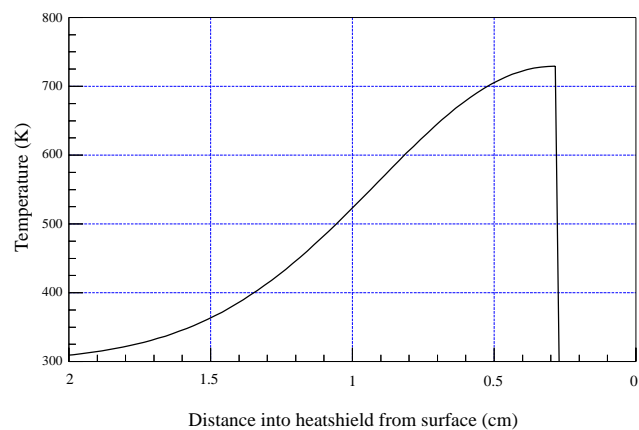

Figure F-14. Temperature profile in the heatshield at a point on the wall of the conical bomblet 10 cm behind the nose, at the time the bomblet would hit the ground.

The original surface of the heatshield is at the right side of the graph and the x-axis gives the distance into the heatshield. The figure shows that less than 3 mm of heatshield have ablated and the temperature has dropped to about 310 K at a distance 2 cm in from the original surface. The heatshield material is reffrasil phenolic.

Cooling of the Spherical Bomblet During Midcourse. We show here that the temperature of a bomblet would decrease only slightly during the roughly 30 minutes between its release from the missile and the beginning of atmospheric reentry if it were in darkness during that time. Appendix A notes that a spherical shell in low-earth orbit in the earth's shadow would have an equilibrium temperature of about 180 K. However, the heat capacity of the bomblets we consider here is large enough that they would remain far from thermal equilibrium after 30 minutes.

We consider the 10-cm-radius spherical bomblet with a 2-cm-thick heatshield of reffrasil phenolic and an initial temperature of 300 K. Assuming it radiates like a blackbody, it will radiate 460 W/m^2 from its full surface area. At the same time, it will absorb infrared radiation from the earth of 240 W/m^2 , which will be absorbed over an effective area of the cross-sectional area of the bomblet. The bomblet assumed here will

therefore radiate a net power of about 50 W, or about $9 \times 10^4 \text{ J}$ over 30 minutes.

If we assume the thermal conductivity of the heatshield is very high, so that the entire heatshield is at the same temperature, then the average change in temperature ΔT of the heatshield due to this loss of heat can be calculated from its heat capacity by

$$\Delta T = 9 \times 10^4 / (c\rho V) = 19 \text{ K} \quad (\text{F-11})$$

where $c = 1174 \text{ J/kg-K}$ is the specific heat of reffrasil phenolic, $\rho = 1632 \text{ kg/m}^3$ is the density, and $V = 0.0025 \text{ m}^3$ is the volume of the heatshield.

Since the actual thermal conductivity of the heatshield is low, there will in reality be a temperature gradient across the heatshield, with the outside surface being cooler than the average and the inside surface being warmer. As a result, the temperature change at the inside surface of the heatshield will be less than the value calculated above.

Appendix G

NASA Air Density Explorer Series Inflatable Balloon Satellites

In the 1960s the United States launched seven small balloon satellites, the last four of which were successfully put in orbit.¹ These satellites, in the Explorer series, were developed during 1956 and 1957 at NASA's Langley Research Center. They were used to make measurements of the Earth's atmospheric density by measuring the effect of atmospheric drag on the balloon's orbit. The first three attempts to put such balloons into orbit, beginning in October 1958, failed due to malfunctions of their rocket boosters. However, the subsequent four balloon launches were all successful. The first balloon successfully put into orbit was Explorer 9, which was launched on 16 February 1961, and the last was Explorer 39, launched in August 1968.

The balloons had a diameter of 3.7 meters. They were constructed of a laminate made from commercially obtained mylar plastic and aluminum foil.² Two different laminate compositions were used. The first three balloons used a three-layer laminate, consisting of two 0.00045-inch-thick aluminum foil sheets bonded to a center layer of 0.001-inch-thick mylar. The last four balloons used a four-layer laminate consisting of alternating layers of 0.0005-inch-thick aluminum and mylar, with the additional inner layer of mylar added to control the temperature of a radio beacon placed inside the balloon.

The materials used to make the laminate were bought commercially in rolls.³ The laminate was cut

into 40 flat gores (a gore is a piece of material that is wider in the middle than at the ends). These pieces were then fabricated into a beach-ball type structure by assembling them over a 3.7-meter-diameter hemisphere. The gores were bonded together using a 3/8-inch overlap between the gores. Two different commercially obtained adhesives were used in bonding the gores together (Goodyear Pliobond and GT-301, a thermosetting plastic made by the G.T. Schjeldahl company).⁴

Starting with the fourth balloon (Explorer 9), a center strip composed of a single layer of mylar was used to divide the balloon into two electrically isolated hemispheres, so the balloon could be used as the antenna for a tracking beacon to be carried inside the balloon (in the case of Explorer 9, this tracking beacon failed shortly after deployment).

Each of the balloons weighed about 10 pounds (4.5 kg), although the deployed weight was greater because of the weight of the radio tracking beacon and its associated batteries and solar cell panels. The deployed weight of Explorer 9 was 6.7 kg.

The radio beacon, which was inside the balloon, had to be kept below a temperature of 333 K (60°C). To reduce the average temperature of the satellite when in sunlight, 3,600 white circles, typically with a diameter of 5.1 cm, were painted on its outer aluminum surface (covering about 17 percent of the surface on Explorer 9 and 25 percent on Explorer 19).⁵ A fourth

¹ Walter Bressette, "Air Density Explorers," in Frank N. Magill and Russell R. Tobias, eds., *USA in Space*, Vol. 1 (Pasadena, Calif.: Salem Press, 1996), pp. 159–162.

² Claude W. Coffee, Jr., Walter E. Bressette, and Gerald M. Keating, "Design of the NASA Lightweight Inflatable Satellites for the Determination of Atmospheric Density at Extreme Altitudes," NASA Technical Note D-1243, January 1962.

³ Edwin J. Kirschner, *Aerospace Balloons* (Fallbrook, Calif.: Aero Publishers, 1985), p. 85.

⁴ Coffee, *et al.*, "Design of Lightweight Satellites," p. 4.

⁵ On Explorer 9, near the location of the beacon, the size and spacing of the white dots was reduced to obtain a more uniform temperature distribution. In addition, an area of about 160 cm² directly over the location of the beacon was painted solid white. See Charles V. Woerner and Gerald M.

inner layer of mylar was also added starting with the fourth balloon. The higher emissivity of mylar relative to aluminum resulted in greater heat transfer due to radiation on the inside of the balloon and thus moderated hot and cold spots on the balloon. These two steps reduced the predicted temperature of the hottest spot on the balloon from about 423 K to 330 K and the temperature difference between the hottest and coldest spots on the balloon from about 116 K to about 53 K.⁶

In order for the balloon to be useful in making drag measurements, it was essential that it retain its spherical shape. Ground tests showed that in order to obtain the strongest sphere it was necessary during inflation to stress the aluminum foil beyond its yield point, which required an inflation pressure of about 0.1 pounds per square inch. With this initial inflation pressure (the gas was allowed to vent out after inflation), ground tests indicated that the balloon should retain its spherical shape down to an altitude of about 75 miles (121 km).⁷

The balloon was folded into a cylindrical package with a diameter of 21.6 cm and a length of 28.0 cm. The greatest difficulty in doing this was removing the air from the folds during the folding process. When deployed in space, it was inflated to a pressure of 0.1 pounds per square inch using a small bottle of nitrogen gas. The deployed balloons were spinning at a rate variously reported to be either 30 or 220 revolutions per minute. Prior to deployment, many tests were performed in a vacuum chamber to ensure the balloon deployment and inflation would work reliably.

The balloons were not designed to hold gas for any period of time, and it was calculated that the gas pressure would fall to 10^{-4} mm of mercury at about 18 hours after deployment (at this pressure it was estimated that the heat transfer via the gas would become negligible).⁸

Keating, "Temperature Control of the Explorer IX Satellite," NASA Technical Note D-1369, April 1962, p. 5.

⁶ These figures assume a balloon altitude of 400 miles (644 km). Coffee, et al., "Design of Lightweight Satellites," p. 50 (figure 17).

⁷ Coffee, et al., "Design of Lightweight Satellites," p. 8.

⁸ Woerner and Keating, "Temperature Control," p. 15.

Appendix H

The Thermal Effects of a Warhead Inside a Balloon

In this appendix we discuss how the presence of a warhead inside a balloon would affect the thermal behavior of the balloon.

If the warhead and balloon are at different temperatures, the warhead will transfer heat to (or from) the balloon in several ways:

- radiation
- conduction through any spacers used to position the warhead within the balloon
- conduction through the gas in the balloon
- motion-driven convection of the gas

Below we discuss the different means of heat transfer, then calculate the effect of the warhead on the balloon's thermal behavior.

Radiation

Since we are only making rough estimates, we will model the warhead as a sphere with a surface area of 4 square meters and a diameter of 1.12 meters. We assume the warhead is concentric with the spherical balloon, which has a diameter of 3 meters.

The power transferred by radiation, P_R , to (or from) the balloon by the warhead is given by¹

$$P_R = \frac{A_W \sigma (T_W^4 - T_B^4)}{\frac{1}{\epsilon_W} + \frac{A_W}{A_B} \left[\frac{1}{\epsilon_{BI}} - 1 \right]} \quad (\text{H-1})$$

where A_W and A_B are the surface areas of the warhead and balloon, ϵ_W and ϵ_{BI} are the infrared emissivities of the warhead's surface and the inside surface of the balloon, T_W and T_B are the temperatures of the warhead and balloon, and σ is the Stefan-Boltzmann constant ($5.67 \times 10^{-12} \text{ W/cm}^2\text{K}^4$).

If we assume that the inside surface of the balloon is a blackbody ($\epsilon_{BI} = 1$),² this equation simplifies to

$$P_R = A_W \epsilon_W \sigma (T_W^4 - T_B^4) \quad (\text{H-2})$$

We assume that the outer surface of the warhead has been given a low emissivity finish (or covered with a thin layer of superinsulation) to reduce the heat transfer. (See Table A-1 in Appendix A for a list of emissivities for different materials.) If we take $\epsilon_W = 0.036$ (corresponding to shiny aluminum) and consider a case in which there is a temperature difference of 10 K between the warhead and balloon ($T_B = 300 \text{ K}$ and $T_W = 310 \text{ K}$), then using equation (H-2) we find that

$$P_R = 9.3 \text{ watts} \quad (\text{H-3})$$

¹ This assumes that the surfaces of the warhead and balloon are diffuse scatterers. If they were specular reflectors instead, the heat transfer would be somewhat less—the denominator in this equation would be replaced by $(1/\epsilon_W + 1/\epsilon_{BI} - 1)$. See Robert Siegel and John R. Howell, *Thermal Radiation Heat Transfer*, 2nd ed. (Washington, D.C.: McGraw Hill, 1981), chapters 8 and 9.

² By making this assumption, we will overestimate the power transferred by radiation. However, since the surface area of the balloon is much larger than that of the warhead, the effect of this assumption is small, unless the emissivity of the inside of the balloon is small. For example, if the emissivity of mylar ($\epsilon = 0.5$, see Table A-1 in Appendix A) was used instead of assuming the inside of the balloon was a blackbody, the power transferred would only be decreased by about 12 percent.

Conduction Through Spacers

The power transfer due to spacers, P_s , can be made negligible by using spacers with low thermal conductivity. The power transfer through a spacer of cross-sectional area A and length L and with thermal conductivity κ is given by

$$P_s = \kappa A(T_w - T_B)/L \quad (\text{H-4})$$

The warhead might be positioned within the balloon using a set of strings that would have very low thermal conductivities. However, to demonstrate that the thermal conductivity can easily be made negligible, we will consider here a set of relatively short and thick spacers: 10 spacers each with a cross-sectional area of 1 cm² and a length of 10 cm. Assuming these spacers are made of commonly available low-conductivity materials such as phenolic or polystyrene, they would have a thermal conductivity of about $\kappa = 0.03$ W/m-K. With the same 10 K temperature difference between the warhead and balloon used above, we find from equation (H-4) that

$$P_s = 0.03 \text{ watts} \quad (\text{H-5})$$

which is a factor of 300 less than that due to radiation. So the heat transfer through spacers can be neglected.

Conduction Through the Gas Used to Inflate the Balloon

What about heat transfer due to conduction through the gas used to inflate the balloon? We assume that the gas used is nitrogen and that a pressure of 69 Pa (0.01 pounds per square inch, or 7×10^{-4} atmospheres) is used to inflate the balloon. As above, we model the warhead as a sphere with a surface area of 4 square meters (and diameter of 1.12 meters), and assume it is concentric with the balloon with a diameter of 3 meters.

The heat transfer between two concentric spheres is given by³

$$P_G = \frac{4\pi\kappa(T_2 - T_1)}{\left(\frac{1}{R_1} - \frac{1}{R_2}\right)} \quad (\text{H-6})$$

where R_1 and R_2 are the radii of the spheres, T_1 and T_2 are the temperatures of the spheres, and κ is the thermal conductivity of the medium between them. The thermal conductivity of nitrogen (at 300 K and one

atmosphere) is 0.0258 W/m-K.⁴ Since the thermal conductivity of a gas is essentially independent of pressure until the mean free path of the gas molecules becomes equal to the size of the enclosure, this will also be the value of κ at a pressure of 69 Pa (7×10^{-4} atmospheres). Assuming the same 10 K temperature difference, equation (H-6) yields

$$P_G = 2.9 \text{ watts} \quad (\text{H-7})$$

Thus, the power conducted through the gas, while smaller than that due to radiation, is not entirely negligible.

However, the attacker could eliminate this means of heat transfer by venting the gas after the balloon was inflated. How rapidly could this be done? The simplest way would be to open a hole in the balloon skin and let the gas vent directly to space. In this situation, a hole with an area of one square centimeter will act as a pump with a speed of 11,700 cm³/sec.⁵ The gas pressure in the balloon, P , will then be given by

$$P = P_0 e^{-\frac{St}{V}} \quad (\text{H-8})$$

where P_0 is the initial pressure, S is the pump speed, V is the volume of the balloon, and t is the time since the hole was opened. If we use a pair of circular holes 7.6 cm (3 inches) in diameter and assume an initial pressure of 69 Pa, we get⁶

$$P = 69 e^{-0.0754t} \text{ Pa} \quad (\text{H-9})$$

As noted above, the thermal conductivity will not decrease until the mean free path of the gas molecules becomes equal to the size of the enclosure. For our balloon, with a diameter of 3 meters, this transition will occur at a pressure of about 0.0027 Pa. From equation (H-9), we find that reaching this pressure would take about 135 seconds, after which the thermal conductivity of the gas would decrease rapidly. If we assume the conductivity decreases in direct proportion to the pressure after the mean free path exceeds the balloon size, then the conductivity would be reduced by a factor of more than 1,000 four minutes after venting begins.⁷

⁴ Yeram S. Touloukian, "Thermophysics," in Herbert L. Anderson, ed. *Physics Vade Mecum* (New York: American Institute of Physics, 1981), p. 323.

⁵ Strong, *Procedures in Experimental Physics*, p. 97.

⁶ A pair of oppositely placed holes is used here to prevent the escaping gas from propelling the balloon.

⁷ As shown in Appendix A and also later in this appendix, empty lightweight balloons will generally reach thermal

³ John Strong, *Procedures in Experimental Physics* (Englewood Cliffs, New Jersey: Prentice Hall, 1938), p. 495.

Convection of the Gas

When a gas heats up, it expands and becomes less dense. In the earth's gravitational field, the heated, less dense air then rises, resulting in convection. However, since the balloon is in free fall in space, there will be no convection driven by temperature difference. However, it is likely that there will be at least some gas motion. In particular, rotation of either the balloon or the warhead would generate gas motion that could be a significant source of heat transfer.

To minimize the heat transfer by gas convection, the balloon and warhead could be attached to each other (by spacers or sets of strings, for example) to minimize the relative motion between them, and the balloon and warhead could be deployed so that they rotate or tumble only slowly. In such a rotating environment, heated gas would tend to flow inward if the warhead at the center of the balloon is colder than the balloon, because of the equivalence of centrifugal force and gravity. But gas heated by a warm warhead at the center would tend to remain near the warhead, so heat transfer by gas convection would not be significant if the warhead were warmer than the balloon.

Alternatively, as discussed above, the gas could be vented after it was used to inflate the balloon. Thus, the attacker has the option of eliminating the heat transfer via both conduction through the gas and convection of the gas by rapidly venting the gas out of the balloon.

Effect of Warhead on Balloon Temperature

The above discussion indicates that, if the gas is vented out of the balloon, radiation will be the dominant mechanism for transferring heat from the warhead to the balloon. If the gas is retained, thermal conduction through the inflating gas will have an effect, but one smaller than radiation. The effects of convection are more difficult to estimate numerically, but can be minimized by fixing the warhead relative to the balloon, keeping

equilibrium in less than four minutes. The power conducted from the warhead to the balloon (or vice versa) will have the effect of preventing the balloon from reaching the equilibrium temperature it would otherwise attain. Once the gas is vented, the balloon would reach this equilibrium temperature. However, as discussed below, the resulting shift in temperature can be made very small by using balloons with equilibrium temperatures close to the warhead temperature. Moreover, during the first few minutes of deployment the balloons would be (or could be, if the attacker desired) spaced closely enough so that they could not be individually resolved by the infrared sensors on SBIRS-low, so that even this small effect would not be observable.

the balloon temperature below that of the warhead, not spinning the balloon, or by venting out the gas.

To illustrate the effect of the warhead on the balloon temperature, we consider two cases. In one case we assume that the total power transferred is equal to that due to radiation, as would be the case if the gas is vented.⁸ In the second case, we assume that motion-driven gas convection is the primary heat transfer mechanism: for this case we take the heat transfer to be five times that due to radiation alone. The key point here is that the precise size of the convective heat transfer does not matter: as can be seen from the discussion below, even large variations in the heat transfer from the warhead to the balloon produce results that are qualitatively similar and that are easily hidden from the defense's sensors.

Figure H-1 compares the thermal behavior following deployment of three lightweight balloons with shiny aluminum foil outer surfaces, masses of 0.5 kg, and initial temperatures of 300 K. The balloons are assumed to be in daylight and tumbling so that all of their surfaces are equally exposed to the sun. One balloon is empty and quickly reaches the expected equilibrium temperature of 454 K. The second balloon contains a warhead with an emissivity of 0.036 and an initial temperature of 300 K, and the heat transfer is assumed to be only due to radiation. As the figure shows, ten minutes after deployment, the temperature of this balloon is reduced by about 11 K, from 454 K to 443 K, relative to the empty balloon. The third balloon also contains a warhead with an emissivity of 0.036; however, here the heat transfer is taken to be five times that due to radiation. After ten minutes, this balloon has a temperature of 410 K.

If the defense knew that the equilibrium temperature of the empty balloon should be 454 K, then these temperature differences could be used to deduce the presence of the warhead. However, the defense will not know the precise surface composition of each of the balloons, so the attacker can easily deny the defense the ability to identify the balloon containing the warhead by using balloons designed to equilibrate over a range of temperatures. As is also shown in Figure H-1, empty aluminum balloons with a small percentage (1–4 percent) of their surface covered with white paint will have equilibrium temperatures varying

⁸ In this calculation, the warhead is assumed to have a heat capacity equal to 900 kg of aluminum. We neglect any heating due to the fissile material in the warhead here, but discuss it later in this appendix.

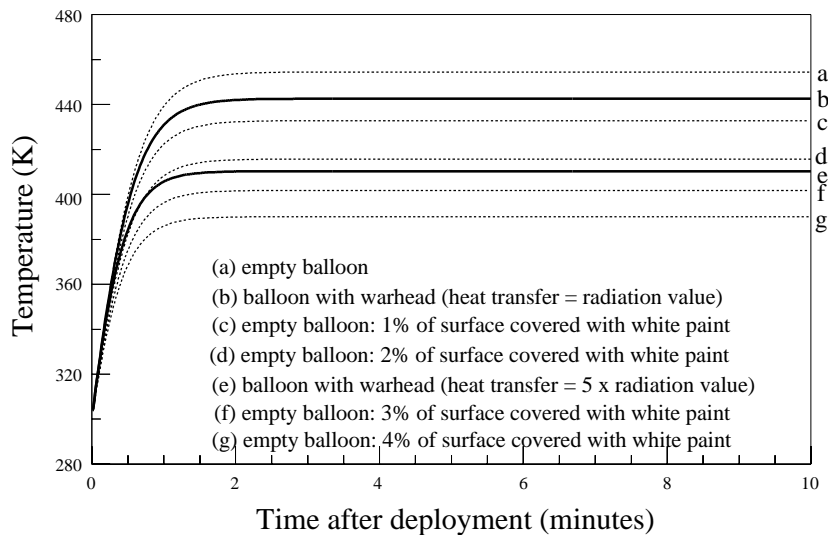

Figure H-1. Temperature variation after deployment of aluminum-coated balloons with and without warheads.

This figure shows the daytime temperature variation after release of lightweight (0.5 kg) balloons with an outer surface of shiny aluminum foil. The balloons are at a temperature of 300 K when released. One balloon is empty and two contain warheads with a surface emissivity of 0.036. For the balloons containing warheads, in one case the heat transfer between warhead and balloon is taken to be that due to radiation, in the other the heat transfer is taken to be five times that due to radiation (the inside surfaces of the balloons are assumed to be blackbodies). Also shown are four empty balloons with small fractions (1–4 percent) of their outer surfaces covered with white enamel paint.

from 390 K to 454 K. Together with the empty balloon with no paint, these temperatures span the temperatures of the balloons containing the warheads. Thus, unless the defense has essentially complete information about the surface composition of the balloons, it cannot determine which balloon contains the warhead based on measurements of the temperature of the balloons.⁹

In fact, while the five empty balloons in Figure H-1 are in thermal equilibrium (subject to the approximation that their surface temperature is uniform), the balloons with warheads are not. This is because the temperatures of the much heavier warheads inside these balloons are still changing, albeit slowly, and therefore the surface temperatures of these balloons are slowly drifting upward. However, this drift is small, about 0.01 K/minute for the balloon with heat transfer equal to five times the radiation heat transfer, and less for the other. As discussed in Chapter 8, in the real world, where the temperature of the balloon will not be uniform over its surface, the complex and changing

⁹ In actual practice, the balloons with the warheads would also be likely to have some amount of paint on their surface, with the amount of paint on the empty balloons adjusted accordingly.

pattern of temperature variations over the surface of the balloon will easily obscure this small drift.

Moreover, the effect of the warhead on the balloon can be made almost negligible by choosing a balloon equilibrium temperature close to that of the initial warhead temperature. Figure H-2 illustrates such an approach. It shows the temperature variation after deployment for balloons coated with a thin layer of aluminum silicone paint, which gives an equilibrium temperature of 299.3 K. As the figure shows, adding a warhead (at 300 K and with an emissivity of 0.036), increases the balloon temperature (after ten minutes) by only about 0.01 K. For a balloon containing a warhead where the heat transfer is taken to be five times that due to radiation, the temperature after ten minutes is increased only by about 0.5 K. For both of these balloons, the temperature drift due to the presence of the warhead is negligible: less than 0.00001 K/minute.

As in the previous example, the presence of the warhead can easily be masked by using small amounts of paint. Figure H-2 also shows the thermal behavior of two empty balloons, one with 0.5 percent of its surface covered with black paint and the other with 0.1 percent of its surface covered with white enamel paint. As the figure shows, even these very small amounts of paint produce thermal variations that would easily mask the presence of a warhead.

Heating Due to the Fissile Material in the Warhead

The discussion up to this point has neglected the heat produced by nuclear reactions taking place in the warhead's fissile material, which we assume to be plutonium. The thermal power produced by nuclear reactions is 2.5 W/kg for weapon-grade plutonium.¹⁰ The specific heat of plutonium at 300 K is 142 J/kg-K. Thus, if thermally isolated from its environment, weapon-

¹⁰ National Research Council, *Management and Disposition of Excess Weapons Plutonium: Reactor-Related Options* (Washington, D.C.: National Academy Press, 1995), p. 45.

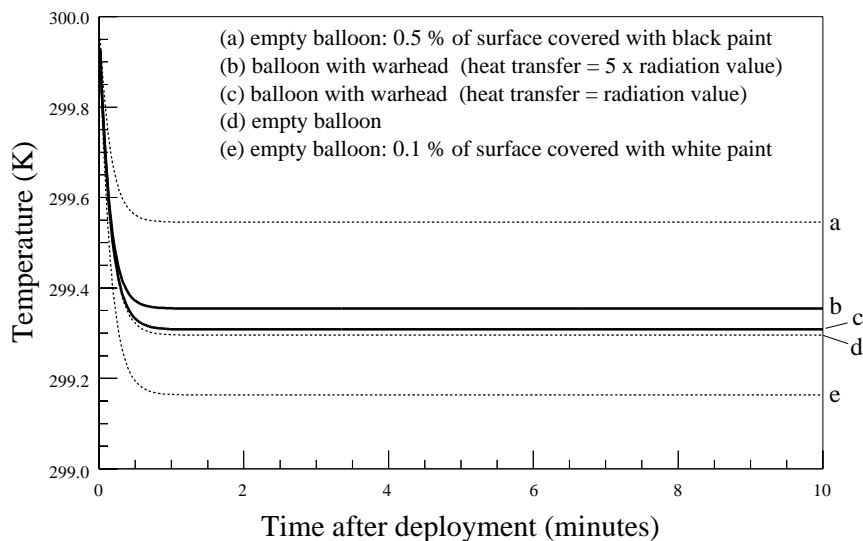

Figure H-2. Temperature variation after deployment of painted balloons with and without warheads, near room temperature.

This figure shows the daytime temperature variation after release of lightweight (0.5 kg) balloons with an outer surface covered with a thin layer of aluminum-silicone paint. The balloons are at a temperature of 300 K when released. One balloon is empty and two contain warheads with a surface emissivity of 0.036. For the balloons containing warheads, in one case the heat transfer between warhead and balloon is taken to be that due to radiation, in the other the heat transfer is taken to be five times that due to radiation (the inside surfaces of the balloons are assumed to be blackbodies). Also shown are two empty balloons with small fractions of their outer surfaces covered with another type of paint: in one case 0.1 percent by white enamel paint, and in the other 0.5 percent by black paint.

grade plutonium would heat at a rate of 0.018 K/s = 1.1 K/minute = 33 K over a 30-minute ICBM flight.¹¹

Of course the fissile material in the core of a nuclear weapon is not thermally isolated; there will be some thermal coupling to the rest of the nuclear weapon and to the outside world. The warhead designer must make sure that this coupling is sufficient to keep the core of

¹¹ The heat generated by reactor-grade plutonium is 5.6 times higher. However, as far as is known, all stockpiled plutonium nuclear weapons (including those of India and Israel) have used plutonium that is weapon-grade or better. The primary problem with reactor-grade plutonium is an increased probability of premature initiation of the detonation because of the increased fraction of Pu-240 in reactor-grade material. This problem can be solved, but it is more difficult to deal with than the greater heating associated with reactor-grade plutonium. A reasonable estimate is that a nuclear weapon built by a country such as North Korea would contain about 6 kg of weapon-grade plutonium. (Marvin Miller, personal communication, December 1999.)

¹² For a discussion of the use of reactor-grade plutonium in constructing a nuclear weapon, including heating effects of the plutonium, see J. Carson Mark, "Explosive Properties of

the weapon from overheating. Note that this issue must be resolved for any nuclear warhead, not just one to be put inside a balloon decoy.¹²

If we assume that a nuclear weapon deployed by an emerging missile state contains 6 kg of weapon-grade plutonium, then the total thermal power produced by nuclear reactions will be 15 W. If we assume the warhead as a whole has a mass of 900 kg with an average specific heat of 0.9 kJ/kg-K, then the total heat capacity of the warhead will be 8.1×10^5 J/K. If we further assume the warhead heats uniformly (which gives the greatest temperature increase at the surface of the warhead, and hence the greatest effect on the balloon), then for weapon-grade plutonium, the warhead would heat at a rate of 1.9×10^{-5} K/s = 0.0011 K/minute = 0.033 K over a 30-minute ballistic missile flight.

How would this nuclear heating affect the above results? To estimate this, we assume that the entire warhead heats at a rate of 1.9×10^{-5} K/s.

Recall that an empty aluminum-coated balloon has an equilibrium temperature of 454 K, that adding a warhead resulted in a temperature 10 minutes after deployment of 443 K (assuming the heat transfer is due to radiation), and that this temperature was drifting upward at a rate of less than 0.01 K/minute. Adding in the heating due to nuclear reactions increases the temperature at ten minutes after deployment by about 0.0006 K and leaves the temperature drift rate essentially unchanged.

For balloons coated with aluminum-silicone paint, the empty balloon had an equilibrium temperature of 299.3 K. The balloon with the warhead (assuming the heat transfer is due to radiation) was at a temperature ten minutes after deployment that was 0.01 K higher, with a negligible upward temperature drift. Adding the

Reactor-Grade Plutonium," *Science and Global Security*, Vol. 4, no. 1 (1993), pp. 111–128 and E. Kankeleit, C. Küppers, and U. Imkeller, "Bericht zur Waffentauglichkeit von Reaktor-plutonium (A Report on the Usability of Reactor Plutonium in Weapons)," Institute für Kernphysik, Technische Hochschule Darmstadt (Germany), December 1989.

effect of nuclear heating increases the temperature at 10 minutes after deployment by 0.0001 K, with a still negligible upward temperature drift of 0.0002 K/minute.

Thus, it is clear that adding the effects of nuclear reaction heating does not in any way change the conclusion that the thermal presence of the warhead can be easily masked.

Appendix I

Shroud Cooling Requirements

There are several external sources of heat that will cause the shroud to heat up once it has been cooled to a temperature of 77 K, unless cooling continues. Above the atmosphere, the sun will deliver about 1,360 W/m² of radiation at visible and near infrared wavelengths. In addition, about 30 percent of the solar radiation that hits the Earth's surface, or 410 W/m², will be reflected upward onto the warhead from the Earth below (this is known as the albedo flux). The radiation flux from the Earth is about 240 W/m² in the long wavelength infrared (at a wavelength of about 10 microns). Finally, the nuclear warhead itself radiates infrared radiation, and some of this will penetrate the insulation and heat the shroud.

We now show that maintaining the temperature of the shroud against the various heat inputs will require the evaporation of about 200 grams of liquid nitrogen per minute.

The thermal power absorbed by the outer wall of the shroud, P_{OUTER} , from sunlight, Earth-reflected sunlight, and infrared Earthshine will be

$$P_{OUTER} = [\alpha_s (S + S_R) + \epsilon_{IR} E] A_C \quad (I-1)$$

where α_s is the solar absorptivity and ϵ_{IR} the infrared emissivity (which is equal to the infrared absorptivity) of the aluminum used to construct the shroud, S is the solar flux (1360 W/m²), S_R is the reflected solar flux from the Earth, E is the Earth infrared flux (240 W/m²), and A_C is the cross-sectional area. For a conical shroud with a height H and a base diameter D , the cross-sectional area will depend on the orientation of the shroud with respect to the sun and Earth. It will range in value from $\pi (D/2)^2$ (for a head-on orientation) to $H(D/2)$ (for a side-on orientation). Since we are interested in calculating the amount of coolant re-

quired to maintain the shroud temperature, we will use the higher value of $H(D/2)$. Equation (I-1) then becomes

$$P_{OUTER} = [\alpha_s (S + S_R) + \epsilon_{IR} E] H (D/2) \quad (I-2)$$

For aluminum that has been polished, the values of α_s and ϵ_{IR} are approximately 0.20 and 0.031, respectively.¹ We assume a shroud with a height of 3 meters and a base diameter of 1 meter. With these values, we obtain a value for P_{OUTER} of 540 watts.

Now we consider the thermal energy transferred to the inner surface of the cooled shroud by infrared radiation from the warhead:

$$P_{INNER} = \epsilon_{si} \sigma (T_W^4 - T_S^4) A_S \quad (I-3)$$

$$\approx \epsilon_{si} \sigma T_W^4 A_S$$

where P_{INNER} is the power absorbed by the inner wall of the shroud, ϵ_{si} is the effective infrared emissivity of the superinsulation between the warhead and shroud, σ is the Stefan-Boltzmann constant (5.67×10^{-8} W/m²-K⁴), T_W is the temperature of the warhead, T_S is the temperature of the shroud, and A_S is the surface area of the shroud.² For a conical shroud of height H and base diameter D , the surface area is given by $\pi (D/2) [(D/2)^2 + H^2]^{1/2}$. Thus, equation (I-3) becomes

$$P_{INNER} = \epsilon_{si} \sigma T_W^4 \pi (D/2) [(D/2)^2 + H^2]^{1/2} \quad (I-4)$$

¹ James R. Wertz and Wiley J. Larson, eds., *Space Mission Analysis and Design* (Boston, Mass.: Kluwer Academic Press, 1991), p. 382.

² The effective emissivity is defined by $q = \sigma \epsilon_{eff} (T_1^4 - T_2^4)$, where q is the energy per unit area and time transferred by radiation between surfaces 1 and 2, T_1 and T_2 are the temperatures of surfaces 1 and 2, and ϵ_{eff} is the effective emissivity of the insulation between surfaces 1 and 2. Wertz and Larson, *Space Mission Analysis*, p. 383.

Assuming that the warhead is at room temperature (300 K), and superinsulation has a relatively high effective emissivity of 0.05,³ the power absorbed by the inner surface of the shroud (with a height of 3 meters and a base diameter of 1 meter) is 110 watts.

Although its effect will be relatively small, we also want to estimate the heat transferred to the inner wall of the shroud from the warhead through the supports that attach the shroud to the warhead. We assume that the shroud inner wall sits on 20 supports resting against the heat shield of the inner warhead, and that each support has a cross section of 1 cm² and a length of 2.5 cm. Thus, the power conducted to the inner surface of the shroud through the supports, $P_{SUPPORTS}$, is given by

$$P_{SUPPORTS} = [\kappa / \Delta X] [T_w - T_s] A_s \quad (I-5)$$

where κ is the thermal conductivity of the supports, ΔX is the length of each support (in this case, $\Delta X = 2.5 \text{ cm} = 0.025 \text{ m}$), T_w and T_s are the temperatures of the warhead and shroud, and A_s is the total cross sectional area of the supports (in this case $A_s = 20 \text{ cm}^2 = 0.002 \text{ m}^2$). Although a material with far lower conductivity could

be chosen,⁴ we will assume the supports are made of Teflon, which we will take to have an average thermal conductivity of $\kappa = 1.0 \text{ W/m-K}$.⁵ Under these assumptions, for a warhead at room temperature (300 K) and a shroud at liquid nitrogen temperature (77 K), the power transferred to the shroud through the supports will be roughly 18 watts.

The total power absorbed by the shroud, P_{SHROUD} , will thus be

$$\begin{aligned} P_{SHROUD} &= P_{INNER} + P_{OUTER} + P_{SUPPORTS} \quad (I-6) \\ &= [540 + 110 + 18] \text{ watts} \approx 670 \text{ watts} \end{aligned}$$

The heat of vaporization of liquid nitrogen is approximately $2 \times 10^5 \text{ J/kg} = 200 \text{ J/g}$, requiring the evaporation of about 3.4 grams of liquid nitrogen per second or about 200 grams per minute. For 30 minutes in space, the amount of liquid nitrogen coolant needed is 6 kilograms, or about 7.5 liters. If the missile was fired on a trajectory so that it was always in the Earth's shadow, the amount of nitrogen need to maintain the shroud at 77 K would be reduced by about a factor of five.

³ Wertz and Larson, *Space Mission Analysis*, p. 384.

⁴ Wertz and Larson, *Space Mission Analysis*, p. 383.

⁵ The thermal conductivity of Teflon is temperature dependent. Reported values of its thermal conductivity include (all in W/m²K): 0.62 at 100 K, 1.0 at 200 K, and 0.42 at 359 K. Y.S. Touloukian, R.W. Powell, C.Y. Cho, and P.G. Klemens, *Thermal Conductivity: Nonmetallic Solids, Thermophysical Properties of Matter*, Vol. 2 (New York: IFI/Plenum, 1970), p. 969; Anthony F. Mills, *Heat Transfer* (Homewood, Ill.: Irwin, 1992), p. 817.

Appendix J

Exoatmospheric Hit-to-Kill Intercept Tests

In this appendix we list the 20 intercept tests that the United States has conducted (through January 2000) with exoatmospheric hit-to-kill interceptors, which are

the tests that are relevant to the development of the current NMD system. Of these tests, 5 intercept attempts hit the target and 15 missed.

Homing Overlay Experiment (HOE)			
<p>The Homing Overlay tests used a large, infrared homing interceptor, which unfurled a fifteen foot diameter set of spokes just prior to intercept.</p>			
<p>HOE Intercept Attempt 1 7 February 1983 The first intercept attempt missed by a large distance. The miss was attributed to problems in the sensor cooling system, which prevented target tracking.</p>	<p>MISS</p>	<p>HOE Intercept Attempt 3 16 December 1983 A software error in the on-board computer was the cause of the third miss. The error prevented the conversion of optical homing data into steering commands.</p>	<p>MISS</p>
<p>HOE Intercept Attempt 2 28 May 1983 The second test was very similar to the first, with the interceptor missing its target by a great distance. While it was able to begin homing, the guidance electronics failed.</p>	<p>MISS</p>	<p>HOE Intercept Attempt 4 10 June 1984 The fourth attempt resulted in a hit for the interceptor, but the target was heated to 100 degrees F to increase its visibility to the interceptor's infrared sensors. According to reports, the target was acquired at a range of "hundreds of miles" and the closing speed was greater than 20,000 feet per second (6 km/s).</p>	<p>HIT</p>
Exoatmospheric Reentry Vehicle Intercept System (ERIS)			
<p>ERIS was part of the Strategic Defense Initiative's ground-based interceptor program and built on technology developed as part of the Homing Overlay Experiment.</p>			
<p>ERIS Intercept Attempt 1 28 January 1991 The target was accompanied on each side by a decoy balloon. The ERIS seeker was programmed to track and hit the center of the three targets. It did not otherwise differentiate between the warhead and decoys. The intercept reportedly occurred at an altitude of 145 nautical miles (270 km) and a closing speed of over 30,000 miles per hour (13.4 km/s).</p>	<p>HIT</p>	<p>ERIS Intercept Attempt 2 13 March 1992 The kill vehicle missed its target by "several meters," in part because it failed to select the target warhead with enough time remaining to maneuver for a hit. The kill vehicle flew between the target and a single balloon decoy separated from the target by about 20 meters.</p>	<p>MISS</p>

Lightweight Exoatmospheric Projectile (LEAP)

In 1992 the Strategic Defense Initiative Organization conducted two test of the LEAP kill vehicle then under development. The LEAP was eventually adopted by the US Navy as the kill vehicle for the Navy Theater-Wide theater missile defense system, and has so far undergone two additional intercept tests in this role.

LEAP Intercept Attempt 1 (Flight Test 2) **MISS**
19 June 1992

This attempt failed when the LEAP missile did not receive data from the ground control system as planned about the target's speed and position .

LEAP Intercept Attempt 2 (Flight Test 3) **MISS**
22 June 1993

The interceptor apparently missed its target by about 7 meters, but very little information is available about this test.

LEAP Intercept Attempt 3 (Terrier/LEAP, FTV-3) **MISS**
4 March 1995

The first intercept test for the Navy Theater Wide Ballistic Missile Defense System. A software error during the second stage of flight caused the third stage of the missile to fly too high and miss its target.

LEAP Intercept Attempt 4 (Terrier/LEAP, FTV-4) **MISS**
28 March 1995

The kill vehicle did not switch to internal power, reportedly because a battery failed, and it passed 170 meters from the target. The Navy was very optimistic despite the intercept failure and termed the test a "clear success," with 42 of 43 test objectives met.

Theater High Altitude Area Defense (THAAD)

The Theater High Altitude Area Defense system is the US Army's ground-based, exo- and high-endoatmospheric interceptor. The system uses a single-stage, solid-propellant missile and a kinetic kill vehicle with infrared guidance in the terminal phase.

THAAD Intercept Attempt 1 (Flight Test 4) **MISS**
13 December 1995

This was the first THAAD test in which the primary objective was a hit-to-kill intercept. A software error caused the Divert and Attitude Control System to misfire and made the kill vehicle veer off course. The trajectory was corrected, but insufficient fuel remained for intercept. A program official said, "the indications are that we should have hit."

THAAD Intercept Attempt 2 (Flight Test 5) **MISS**
22 March 1996

Twenty seconds into the flight a lanyard connecting the kill vehicle to its supporting electronics module disconnected, effectively shutting down the interceptor before booster separation. The interceptor stopped responding to ground controls, flew past its target, and was subsequently detonated.

THAAD Intercept Attempt 3 (Flight Test 6) **MISS**
15 July 1996

The interceptor's seeker electronics malfunctioned, overloading the signal processor and preventing target acquisition. An independent review panel found no major problems in the program but recommended that testing be slowed and "more emphasis placed on intercepting a target instead of meeting an aggressive test schedule." One official said that he "believe[d] they will dramatically restructure the program" if the missile failed to intercept during its next test.

THAAD Intercept Attempt 4 (Flight Test 7) **MISS**
6 March 1997

The Divert and Attitude Control System (DACS) failed and the missile flew out control. One official complained, the DACS "did not work. It never worked. What we don't know is why it didn't work."

Theater High Altitude Area Defense (continued)

THAAD Intercept Attempt 5 (Flight Test 8) **MISS** 12 May 1998

Originally scheduled for December 1997, the test was postponed due to problems in the missile's inertial measurement unit and concerns over system readiness. The test ended early as a short-circuit in the thrust vector control assembly sent the interceptor out of control.

THAAD Intercept Attempt 6 (Flight Test 9) **MISS** 29 March 1999

The missile lost track of the target, missed it by about 30 yards and self-destructed. Sources said that the missile "did not take over and make the final adjustments... to intercept the target." The miss was eventually attributed to a failure in one of the thrusters used to steer the interceptor. The Pentagon initially reported success in 16 of its 17 test goals, but later stated that 2 out of 4 was more accurate.

THAAD Intercept Attempt 7 (Flight Test 10) **HIT** 10 June 1999

Following several test delays, the THAAD hit—the first

time in seven attempts. Brig. Gen. Richard Davis, USAF, was very optimistic: "The technology can work. We've shown it to be able to work. No longer will we say that the design is flawed." This test used a Hera target missile flown on a highly lofted trajectory. The target flew at about 2 kilometers per second at intercept and the intercept occurred at 60–100 kilometers altitude. While the THAAD missile hit its target, no countermeasures were employed, making this a less difficult scenario than THAAD could face from a real-world threat.

THAAD Intercept Attempt 8 (Flight Test 11) **HIT** 2 August 1999

The test used a Hera target missile flown on a highly lofted trajectory. The 4-meter-long reentry vehicle separated from the missile booster. Intercept occurred at above 80 kilometers altitude and probably at well above 100 kilometers. The target was traveling at about 2 kilometers per second at intercept. Again, no countermeasures were employed.

National Missile Defense (NMD)

The NMD ground-based interceptor consists of an exoatmospheric kill vehicle (EKV) on top of a booster. The booster will be a three-stage missile based in an underground silo. The NMD EKV has its own seeker, propulsion, communications, guidance, and computers to support targeting decisions and maneuvers.

NMD Intercept Attempt 1 (IFT-3) **HIT** 2 October 1999

The test was originally scheduled for June 1999, but was postponed several times, reportedly due to a series of minor problems with the kill vehicle. A surrogate booster carried the prototype exoatmospheric kill vehicle from the Kwajalein Missile Range to intercept a target launched from Vandenburg AFB, California. The intercept reportedly occurred at about 140 miles (225 km) altitude at a closing speed of 15,000 miles per hour (6.7 km/s). The NMD ground-based radar observed the test but was not used to guide the kill vehicle—instead a global positioning system transmitter on the mock warhead (along with a backup C-band radar beacon) told the interceptor missile where to release the kill vehicle. In January 2000, the Pentagon acknowledged a series of anomalies in the test that led to the kill vehicle initially being unable to find the mock warhead. Eventually, the kill vehicle started to home instead on the bright balloon decoy that was included in the test. Fortuitously,

the balloon and warhead were close enough together that the warhead then appeared in the field of view of the kill vehicle, which was then able to home on and intercept the warhead. According to the 1999 annual report by the Pentagon's Director of Operational Testing and Evaluation, there is no basis to classify the test as either a success or failure since it is unclear whether the intercept would have occurred if the brighter balloon had not been present.

NMD Intercept Attempt 2 (IFT-4) **MISS** 18 January 2000

This test differed from IFT-3 in that it incorporated other components of the system, including the Defense Support Program early warning satellites, the prototype ground-based radar on Kwajalein, and the battle-management system in Colorado. A failure of the two infrared sensors on the kill vehicle caused it to miss the mock warhead, reportedly by a distance of 100 feet.

Contributor Biographies

John M. Cornwall is a professor of physics at UCLA and a professor of science and policy analysis at the RAND Corporation's graduate school. In addition to his work in elementary particle theory and space plasma physics, he has for many years served as a consultant to the government on ballistic missile defense, nuclear stockpile stewardship, synthetic aperture radar, satellites and their sensors, ionospheric phenomena, and verification of arms control treaties. Cornwall is a member of the JASON group and has served on the Defense Science Board and on various review panels at Los Alamos and Livermore Laboratories, as well as at the Defense Threat Reduction Agency. He has been a consultant to the Aerospace and MITRE Corporations and has served on boards and panels for the Center for International Security and Arms Control at Stanford University, the UCLA Center for International and Strategic Affairs, and the John D. and Catherine T. MacArthur Foundation. Cornwall has been a visiting professor at the Niels Bohr Institute in Copenhagen, the Institute de Physique Nucleaire in Paris, the Institute of Theoretical Physics at the University of California, Santa Barbara, and the Massachusetts Institute of Technology. He received his Ph.D. in physics from the University of California, Berkeley.

Bob Dietz was a systems engineer at the Lockheed Missile Division in Sunnyvale, California, until his retirement in 1990. His responsibilities were mainly in the areas of penetration aids (Polaris), post-boost vehicle design (Poseidon, Trident), guidance, functional control, trajectory analysis and performance analysis. From 1980 on, he was responsible for advanced design studies involving submarines as a launch platform. He participated in SDI-related studies including synthesis of foreign missiles for vulnerability analysis and con-

ceptual design of responsive missiles against SDI conceptual architecture. Beginning in the mid-1980s, he participated in foreign missile analysis and synthesis as a contractor to various intelligence organizations. His work included analysis of intercepted telemetry, intercepted communications, and overhead photography. In the late 1980s, he was involved in analyzing the impact of arms control initiatives on US submarine-launched ballistic missile systems. He received a B.S. degree in electrical engineering from the University of California, Berkeley.

Steve Fetter is a professor in the School of Public Affairs at the University of Maryland. One of his principal areas of research is arms control and nonproliferation. He is author of *Toward a Comprehensive Test Ban*, and coauthor of *The Future of US Nuclear Weapons Policy* and *The Nuclear Turning Point*. During 1993–94, Fetter served as special assistant to the Assistant Secretary of Defense for International Security Policy, for which he received an award for outstanding public service. He has also been a Council on Foreign Relations fellow at the State Department; a visiting fellow at Stanford University's Center for International Security and Arms Control, Harvard University's Center for Science and International Affairs, and Lawrence Livermore National Laboratory; and a consultant to several US government agencies. Fetter serves on the National Academy of Sciences' Committee on International Security and Arms Control, the Executive Committee of the Forum on Physics and Society, the National Council of the Federation of American Scientists, and the board of directors of the Arms Control Association. Fetter received a Ph.D. in energy and resources from the University of California, Berkeley, and a S.B. in physics from MIT.

Sherman Frankel is a professor of physics at the University of Pennsylvania. His fields of specialization are particle and relativistic nuclear physics as well as research dealing with physics and public policy, including issues related to strategic defense, post-launch control of nuclear-armed missiles, and arms control treaties. His most recent technical publications, dealing with electronic decoys and missile defense, have appeared in the US Navy journal *Surface Warfare, Science and Global Security, Arms Control Today*, and the *Bulletin of Atomic Scientists*. He has been the associate editor of the *Review of Scientific Instruments*. He has been a guest scientist at the Niels Bohr Institute, CERN, and CEN de Saclay, and a guest fellow at the Brookings Institution and at Stanford's Center for International Security and Arms Control. He is a fellow of the American Physical Society and has twice been a John Simon Guggenheim Fellow. Frankel holds a Ph.D. in physics from the University of Illinois.

Richard L. Garwin was a member of the Rumsfeld Commission to Assess the Ballistic Missile Threat to the United States. He is a member of the JASON group of consultants to the US government and has consulted for the US nuclear weapons laboratories since 1950. He was a member of the Defense Science Board, and chaired the Military Aircraft and Naval Warfare Panels for the President's Science Advisory Committee. His work for the government has included studies on antisubmarine warfare, sensor systems, military and civil aircraft, and satellite and strategic systems. He has coauthored many books, among them *Ballistic Missile Defense* and *Managing the Plutonium Surplus*. He is a member of the International Institute for Strategic Studies. In 1996, he received both the R.V. Jones Award for Scientific Intelligence and the Enrico Fermi Award from the President and the Department of Energy for contributions to nuclear weapons. He was also awarded the 1983 Wright Prize for interdisciplinary scientific achievement, the 1988 AAAS Scientific Freedom and Responsibility Award, and the 1991 Erice "Science for Peace" Prize. He is a long-time member of Pugwash and is a member of the board of directors of the Union of Concerned Scientists. Currently, he is Philip D. Reed Senior Fellow for Science and Technology at the Council on Foreign Relations. He is also fellow emeritus at the Thomas J. Watson Research Center of IBM, and chairs the State Department's Arms Control and Non-proliferation Advisory Board. He received a Ph.D. in physics from the University of Chicago.

Kurt Gottfried is an emeritus professor of physics at Cornell University. He has published widely on issues such as ballistic missile defenses, anti-satellite weapons, strategic command and control, nuclear testing, and European security. He directed a major study involving senior military officers and leading experts on command and control, published by Oxford University Press in 1988 as *Crisis Stability and Nuclear War*. A cofounder and currently chair of the board of directors of the Union of Concerned Scientists, he directed its studies of the first ABM system in 1969, and of antisatellite weapons and the Strategic Defense Initiative in the 1980s. He received the 1991 Leo Szilard Award of the American Physical Society (APS). He has been on the scientific staff of CERN in Geneva, served on the High Energy Physics Advisory Panel of the Department of Energy and the National Science Foundation, and served as chair of the Division of Particles and Fields of APS. He was a Junior Fellow and Assistant Professor at Harvard University, and served as chair of the physics department at Cornell. He is a member of the American Academy of Arts and Sciences and the Council on Foreign Relations. Gottfried received his Ph.D. in physics from MIT.

Lisbeth Gronlund is a senior staff scientist at the Union of Concerned Scientists and a research fellow in MIT's Security Studies Program. Her recent research has focused on technical issues related to ballistic missile defenses. Other areas of research include ballistic missile proliferation, international fissile material controls, and transparency measures to facilitate deep reductions in nuclear weapons. Previously, she was an SSRC-MacArthur Foundation Fellow in International Peace and Security at the Center for International Security Studies at the University of Maryland and a postdoctoral fellow at the MIT Defense and Arms Control Studies Program. She currently serves as a member of the American Physical Society's (APS) Panel on Public Affairs, on the board of directors of the Educational Foundation for Nuclear Science, which publishes the *Bulletin of the Atomic Scientists*, and as an associate editor of *Science and Global Security*. She has served on the Executive Committee of the APS Forum on Physics and Society. Gronlund received a Ph.D. in physics from Cornell University.

George N. Lewis is an associate director of MIT's Security Studies Program. His current research focuses on ballistic missile defense and deep reductions in

nuclear weapons. His research has included studies of arms control and verification for sea-launched cruise missiles and other nonstrategic nuclear weapons, air surveillance and early warning systems, the effectiveness of tactical missiles and defenses against them, and the performance of the Patriot missile defense system in the 1991 Gulf War. He is a contributor to *Nuclear Weapons After the Cold War* and *The Nuclear Turning Point*. Before coming to MIT, he conducted research at the Cornell Peace Studies Program and the Center for International Security and Arms Control at Stanford University. He is an associate editor of *Science and Global Security* and has served on the Social Science Research Council Committee on International Peace and Security. Lewis received his Ph.D. in physics from Cornell University.

Theodore A. Postol is Professor of Science, Technology, and National Security Policy at the Massachusetts Institute of Technology. His work has included technical and policy analyses of a variety of arms control issues, such as strategic and tactical missile defenses, nuclear weapon targeting practices, accidental launch protection systems, and Soviet tactical missile threats to NATO. His recent work has focused on the Patriot anti-missile system's performance during the 1991 Gulf War and the implications of advanced theater missile defense systems for the ABM Treaty. Previously, he served as the principal advisor to the Chief of Naval Operations at the Pentagon on ballistic missile technologies, among other matters. As an analyst at the congressional Office of Technology Assessment, he studied the MX missile. He has also held posts at Stanford's Center for International Security and Arms Control and at the Argonne National Laboratory. In 1995, he received the Hilliard Roderick Prize of the American Association for the Advancement of Science, and in 1990 the Leo Szilard Award of the American Physical Society. Postol holds a Ph.D. in nuclear engineering from MIT.

Andrew M. Sessler is a senior scientist at the Lawrence Berkeley National Laboratory and a past president of the American Physical Society (APS). He has been at

the Berkeley Laboratory since 1962, serving as its director from 1973 to 1980. In addition to his work in basic physics, he has been active in arms control, for example, serving as a member of the APS study group on Science and Technology of Directed Energy Weapons and, for four years, as chair of the Federation of American Scientists. He cofounded the human rights group, Scientists for Sakharov, Orlov and Sharansky (SOS) for which he received the first APS Nicholson Medal for Humanitarian Service in 1994. Other awards include the Ernest Lawrence Award, the US Particle Accelerator School Prize, and the Wilson Prize. He was also named a Leland Haworth Distinguished Scientist at Brookhaven National Laboratory in 1991. He is the author or coauthor of over 300 published works, primarily on the physics of particle beams. He is a Senior Member of the Institute of Electrical and Electronics Engineers (IEEE), and a Fellow of the New York Academy of Sciences and of the APS. Currently he is spokesperson for the Neutrino Factory and muon Collider collaboration. Sessler received his Ph.D. in physics from Columbia University.

David C. Wright is a senior staff scientist at the Union of Concerned Scientists and a research fellow in the Security Studies Program at MIT. Previously he was an SSRC-MacArthur Foundation Fellow in International Peace and Security at Harvard's Center for Science and International Affairs, and a senior arms control analyst at the Federation of American Scientists. His current research includes ballistic missile defenses and technical analysis of ballistic missile development programs. He testified before the Rumsfeld Commission on the North Korean missile program, and has also testified before the Senate Foreign Relations Committee on the state of ballistic missile defense technology. He has also written on international fissile material controls, estimates of Chinese production of plutonium for weapons, and depressed-trajectory ballistic missiles. He served on the Social Science Research Council Committee on International Peace and Security and is currently an associate editor of *Science and Global Security*. Wright received his Ph.D. in physics from Cornell University.

